

# STATION INSTALLATION & REPAIR MANUAL



DEC. 1972

**STATION  
INSTALLATION  
AND  
REPAIR  
MANUAL**

This material is Prepared for Bell Canada purposes and is for the use of Bell Canada employees and other Canadian Telephone Companies with whom Bell Canada has special agreements only. Its distribution is in no sense a publication. Neither the material nor any portion thereof is to be reproduced in any form by others without the written permission of Bell Canada.

Printed in Canada

Please note:

Pages can be accessed directly based on the numbers shown in the TOC.

Click on TOC in the bookmarks on the left to go to the Table of Contents or on info to go back to this page.

## TABLE OF CONTENTS

SECTION	ISS.	SUBJECT	PAGE
<b>FIRST AID</b>			
010-100-010CA	F	Prevention of Skin Irritation from Poles and Wood Products Treated With Creosote and Pentachlorophenol . . . . .	1
Q10-100-012CA	C	Rescue of Employee from Pole	3
O10-100-013CA	B	Rescue of Person from Live Wire on Ground	7
010-100-910CA	C	Prevention of Skin Irritation from Poison Ivy, Kerodex 71 Barrier Cream	11
<b>GENERAL INFORMATION</b>			
469-050-902CA	D	Customer Relations - Installers and Repairmen	331
469-050-950CA	D	Plant Department Sales - Methods and Handling	337
469-052-930CA	B	Inspections on Station Visits - Installers and Repairmen	343
500-810-900CA	C	Handling Packing and Returning Station Supplies	359
<b>PROTECTION MEASURES</b>			
460,100-400CA	B	Station Protection and Grounding	105
460-110-100CA	C	Special Service Protection Special Safeguarding Measures	133
501-375-100CA	B	Ringer Isolator (P0895087 Kit of Parts) Identification	411
620-105-010CA	F	Observations and Voltage Tests to Be Made Before Working at Joint Use Poles	5,25
620-131-010CA	F	Precautions to be Taken Before Climbing Poles or Working From Strand or Pole Supported Equipment	531
620-132-010CA	D	Safeguards to be Taken Before Climbing Poles - Testing Poles	535



**TABLE OF CONTENTS (cant'd)**

<b>SECTION</b>	<b>ISS.</b>	<b>SUBJECT</b>	<b>PAGE</b>
<b>PROTECTION MEASURES (Cant)</b>			
620-133-010CA	B	Safeguard to be Taken Before Climbing Poles - Temporary Supports .....	539
<b>STATION DIALS</b>			
501-162-101	5	Type 9 - Identification and Maintenance ..	367
50i1-162-900CA	A	Type QDB - Identification and Maintenance	373
501-164-105CA	A	Type 25, - Identification and Maintenance	379
501-164-115CA	C	Type 35 - Identification and Maintenance	387
<b>TELEPHONE APPARATUS</b>			
46-3-,110-200CA	C	Auxiliary Signals - Installation and Maintenance	305
<del>463-110-400CA</del>	E	Auxiliary Signals - Connections	311
463-233-900CA	B	Voice Station Couplers QCS-Type - Description, Installation, Maintenance and Tests	317
500-H6-400CA	B	Ringer Connections - Tip Party Identification for Stations Connected to Long-Line Equipment	355
501-252-100CA	F	QCY1A1 Bell Chime	403
<b>TELEPHONE SETS</b>			
500-H2-100CA	E	Inductive Noise - Description and Maintenance Procedures	345
500-120-100CA	E	Telephone Apparatus - Colour	357
502-210-400CA	C	Subscriber Sets - Extension Ringer - Connections	413
502-321-910CA	D	QSK100AX and QSK2100AX "Contempra"	415
502-321-9HCA	B	Contempra - Message Waiting QSK100BX	431

**TABLE OF CONTENTS (cont'd)**

<b>SECTION</b>	<b>ISS.</b>	<b>SUBJECT</b>	<b>PAGE</b>
<b>TELEPHONE SETS (Cont)</b>			
502-400-401CA	C	302G Common Battery Connections	435
502-510-100CA	F	500 and 554 Types - Identification, Installation and Maintenance	, 437
502-510-121CA	C	1500 (M.D.), 1554 (M.D.), 2500 and 2554, Identification, Installation and Maintenance	, 453
502-510-401CA	E	Type 500C, D Connections	457
502-510-410CA	D	554B Common Battery - Connections	459
502-510-450CA	D	1500D, <del>2500D</del> , 1554B and 2554B - Connections	, ..... 461
502-515-121CA	C	1511 DQA (M.D.) 2511 DQA Types - Identification, Installation and Maintenance	471
502-515-400CA	E	502, <del>510</del> and 511 Types Common Battery - Connections	, 475
502-515-401CA	A	558, B & D Types Common Battery - Connections	, 481
502-5,20-402CA	D	532B - (Amplifier Sets for Impaired Hearing) Common Battery Connections	.... 485
502-710-101CA	A	701-702, and 711 Types Identification, Installation and Maintenance	, 487
502-710-400CA	F	701B - Connections	505
502-710-401CA	A	701D - Connections	513
502-710-403CA	C	702BQIA - Connections	515
502-710-410	3	711B - Connections	521
<b>TOOLS</b>			
075-160-301CA	A	Screwdrivers - Selection, Use and Maintenance	..... 13

**TABLE OF CONTENTS (cont'd)**

<b>SECTION</b>	<b>ISS.</b>	<b>SUBJECT</b>	<b>PAGE</b>
<b>TOOLS (Cont)</b>			
080-120-101CA	B	Grounding Portable Electric Power Tools	21
081-020-010CA	B	Z Protective Cap .....	35
081-020-934CA	B	NE714QA Tool .....	39
081-710-200CA	G	Insulating Gloves - Description Care and Maintenance	43
081-720-011CA	H	Body Belts (Leather)	51
081-721-200CA	F	Fabric Safety Straps	55
081-721-300CA	F	C Body Belts - Inspection and Maintenance .....	61
081-730-101CA	C	Climbers	63
081-740-105CA	B	Extension Ladders and Attachments - Description and Use... ..	73
106-220-925CA	A	Z Voltage Tester	101
<b>VEHICLE OPERATION</b>			
nO-100-901CA	K	Vehicles Operators Driving Instructions and Precautions - Specific Cases Requiring Special Care - Parking Instructions - Skidding	621
<b>WIRING</b>			
<b>Attachments</b>			
080-720-101CA	E:	Attachments, Fasteners and Methods for Running Inside Wire and Cable	25
<b>Buried</b>			
629-760-2mCA	A	Buried Wire - Connections - Kit Encapsulation	567
<b>Wire and Cable-Inside</b>			
461-200-200CA	D	Selection of Route for Station Wire and Cable	149

**TABLE OF CONTENTS (cont'd)**

<b>SECTION</b>	<b>ISS.</b>	<b>SUBJECT</b>	<b>PAGE</b>
<b>WIRING (Cont)</b>			
<b>Wire and Cable-Inside (Cont)</b>			
461-200-203CA	G	Handling Wire and Cable	163
461-630-100CA	D	Jacks and Plugs	171
<b>Drop and Block</b>			
462-200-200CA	E	Drop and Block Wiring Splicing	179
462-240-200CA	E	Drops from Open and Rural Wire Lines	187
462-300-200CA	D	Pole and Guard Arm Attachments	193
462-300-205CA	B	Strand Attachments	197
462-350-213CA	B	Fastening and Equipping First Attachments of Drop Wire Runs to Building	199
462-350-2HCA	B	Fastening and Equipping Intermediate and Last Attachments for Drop and Block Runs on Buildings	211
462-400-205CA	B	Placing Drop Wire - Voltages Less Than 300 Involved .....	225
462-400-206CA	B	Placing Drop Wire - Voltages of 300 to 750 Involved	233
462-400-211CA	B	Pole-to-Building and Pole-to-Pole Runs .....	237
462-450-205CA	E	Separation and Mechanical Protection .....	<b>243</b>
462-460-200CA	C	Placing Wire and Cable for Auto-Trailers	251
462-500-011CA	D	Multiple Drop Wire - Stringing Sags .....	255
462-500-100CA	C	Multiple Drop Wire - Description	257
462-500-200CA	E	Multiple Drop Wire - Placing	259

**TABLE OF CONTENTS (cont'd)**

<b>SECTION</b>	<b>ISS.</b>	<b>SUBJECT</b>	<b>PAGE</b>
<b>WIRING (Cant)</b>			
<b>Drop and Block (Cant)</b>			
462-500-900CA	C	X-Multiple Drop Wire	267
46,2-800-311CA	B	Lowering and Replacing Drop Wire - Voltages Less than 300 Involved	2:77
462-80Q-312CA	B	Lowering and Replacing Drop Wire - Voltages of 300 to 750 Involved	287
462-800-500CA	A	Testing and Fault Locating	291
<b>Clearances</b>			
620-2,10-011CA	D	Clearances and Separations for Aerial - Communication Plant	543
620-215-011CA	D	Joint Use Clearances in the Span and Separations at the Pole .....	555
620-220-011CA	B	General - Separations for Drop and Block Wiring .....	563
<b>Dedicated Plant</b>			
642-220-201CA	D	Pole and Wall Mounted Cabinets for Control and Access Points	593
642-235-202CA	D	Buried Cable - Control and Access Points - Wiring Arrangements	601
<b>Terminals</b>			
631-240-206CA	G	MD3209' and MD3208 Cable Terminal - Terminating Conductors	571
63,1-600-100CA	A	QTC Type Terminals - Service Wire & Terminal Block - Installation & Termination	575
631-620-912CA	A	4086B JW1 Cabinet - Placing and Removing Jumper Wires	585

## TABLE OF CONTENTS (cont'd)

ADMINISTRATIVE INFORMATION	631
Equipment and Material	631
Handsets	631
Uniform Service Order Codes	632
PLANT SALES	640
Pic Cable Colour Codes	642
STATION ACCOUNTING	643
Change of Location of Telephone Sets	643
Accounting Classification Sketches	643
Reporting Drop and Block Wires	644
Examples of New Installs and Reinstalls	644
Outside Plant and Station Account Codes	645
STATION TESTS	646
ANI INSTRUCTIONS	648
NO.1 ESS and SPI Instructions	649
SERVICE ORDERS	651
Missed Appointments	651
Left-in Telephones and Removals	651
Reporting Completions	652
Box Space Entries	653
TELEPHONE NUMBERS	654
UNIVERSAL SERVICE ORDER (USO)	656
Plant Sales	656
Guide for Service Order statistical entries	657
Order Classification	658
Action Codes	658
USOC Suffixes	659
Alphabetical List of Mnemonic Codes	661





FIRST AID AND PREVENTION OF SKIN  
IRRITATION FROM POLES AND WOOD PRODUCTS  
TREATED WITH CREOSOTE AND PENTACHLOROPHENOL

	CONTENTS	PAGE
1.	GENERAL . . . . .	1
2.	CAUSE OF IRRITATION . . . . .	1
3.	PREVENTIVE MEASURES . . . . .	1
4.	FIRST AID . . . . .	1

1. GENERAL

1.01 With the use of Creosote, P Wood Preservative and Pentachlorophenol (Penta) treated poles and wood products, preventive and safety measures must be taken to avoid skin irritation.

1.02 This section is reissued to shorten and clarify the text. As this is a general revision, marginal arrows normally used to indicate changes have been omitted.

2. CAUSE OF IRRITATION

2.01 Both tar acids and Penta used in treating poles, etc., contain skin irritant products which are increased by hot weather or when newly treated.

3. PREVENTIVE MEASURES

3.01 Before climbing or handling such treated poles, etc.:

- (a) Wear long sleeve shirts with sleeves rolled down.

- (b) Wear gloves and keep the neck well covered.

- (c) Keep pants or overall legs rolled down.

- (d) Apply Kerodex 71 Barrier Cream to exposed skin surfaces after washing thoroughly.

- (e) Do not rub eyes or remove perspiration from them with shirt sleeves or hands that have been exposed.

- (f) If direct contact with the skin occurs wash with plenty of hot water and soap.

- (g) Before lunch and immediately after work wash hands, arms, face and neck with plenty of soap and hot water. When washing, keep hands away from eyes.

- (h) Articles of clothing that have been exposed should be soaked in hot soapy water as soon as possible.

4. FIRST AID

4.01 Should eye burn or skin irritation occur:

- (a) Flush the eyes with water for 10 to 15 minutes, seek assistance from a fellow worker.

- (b) Cover the eye with an eye pad and obtain medical aid immediately.

- (c) If skin has become irritated apply "Creosote Burn Wash" from the First Aid Kit. This wash should not be applied in or near the eyes.

- (d) If the irritation continues for 24 hours or if a large skin area is affected seek medical aid.



## FIRST AID

### RESCUE OF EMPLOYEE FROM POLE

Contents	Page
1. GENERAL . . . . .	3
2. PLANNING THE RESCUE . . . . .	4
3. REMOVING EMPLOYEE FROM CONTACT WITH LIVE CIRCUIT OF LESS THAN 15,000 VOLTS	4
4. REMOVING EMPLOYEE FROM CONTACT WITH LIVE CIRCUIT OF MORE THAN 15,000 VOLTS	5
5. ASCENDING THE POLE . . . . .	5
6. REMOVING EMPLOYEE FROM CONTACT WITH WIRES AND LOWERING HIM . . . . .	5
7. ARTIFICIAL RESPIRATION AND OTHER FIRST AID . . . . .	6

**1. GENERAL**

**1.01** This Section specifies methods of rescuing an employee working aloft when, on account of electric shock or for any other reason, help is required to lower him to the ground.

**1.02** This section is reissued to refer to the new St. John Ambulance Association Text Book-Fundamentals of First Aid and to refer to Insulating Gloves.

**1.03** *In an electric shock accident, quick rescue and the prompt application of artificial respiration*, if normal breathing has stopped, are extremely important. In some cases, the injured person may remain in contact with the wire because of his inability to let go of the live conductor or due to his being unconscious.

**1.04** Unless it is definitely known that the cause of the disability is not electric shock, or that there is no danger of electric shock, *it should*

*be assumed that all of the wires on the pole are energized with dangerous voltages.* In this event the rescuer should take precautions as specified in these instructions to protect himself and his assistants from injury due to electric shock.

**1.05** In all cases where the employee has received a severe electric shock or is unconscious, have someone call a physician to the location as soon as practicable without delaying the rescue. If the victim is conscious and, after receiving first aid can safely be moved, he should be taken where he may receive the services of a physician. In administering first aid and transporting the victim, follow the recommendations covered in the St. John Ambulance Association Textbook — Fundamentals of First Aid.

**1.06** Send someone to get the truck, as soon as practical if it is not near the scene of the accident, as it may contain useful equipment or it may be needed as an insulated platform to effect the rescue and to transport the injured employee.

**1.07** In electric shock cases, notify as soon as practical, the power company which operates the equipment involved in the accident.

**1.08** If the cause of the disability is not electric shock, the rescue work may be conducted more deliberately and without the speed which is essential in electric shock cases.

**1.09** Review this practice and also the St. John Ambulance Association Textbook — Fundamentals of First Aid at intervals so that if an accident on a pole should occur, the rescue work will be handled effectively.

**1.10** For each power line operating voltage between wires there is a corresponding smaller voltage between wires and ground. The likeli-

## SECTION 010-100-012CA

hood of a telephone employee touching two wires of a power circuit is remote. Therefore, in case of personal contact, the voltage against which protection needs to be provided is the voltage to ground. In the following pages references are made to circuit voltage of 15,000 volts, corresponding to which the voltage-to-ground is 8,700 volts, against which Insulating Gloves in good condition provide positive protection.

### 2. PLANNING THE RESCUE

**2.01** Before starting the rescue, plan quickly, but carefully, how the operation can best be carried out. The most important details to be considered are the following:

- (a) Probable cause of the disability (electric shock, sickness, fainting, etc.). In an electric shock case determine, if possible, the source of the shock and whether or not the contact has been cleared. If the source is not apparent or if the nature of the disability cannot be determined from the ground, assume that the injured person has been shocked and that the contact still exists, and use the protective measures applying to such cases.
- (b) Rescue tools available such as rope, Insulated Gloves, pliers, tree pruner, climbers, body belt, safety strap, ladder. (An extension ladder may be used, under some conditions, to facilitate the removal of the victim.)
- (c) Assistants to help handle rope in lowering him from pole.
- (d) Position of victim with respect to wires and other attachments on pole.
- (e) Method to be used in clearing contact between victim and source of shock. (Lifting him clear, opening switch, cutting wires, etc. If wires are to be cut, consider possibility of unsound pole falling due to unbalanced load effect on the pole.) Observe Paras. 3.06 and 5.06.
- (f) Side of pole to be climbed and position from which rescue work will be done.
- (g) Point of attachment for rope to be used in lowering the employee.
- (h) Need for cutting wires below victim which might interfere with rescue work and the lowering operations.

- (i) Protection of rescuer from electric shock (if pole, rope or other equipment is wet).
- (j) Availability of truck to be used (with necessary precautions) as an insulated platform, particularly under wet conditions.

**2.02** If the necessary equipment or help is not available to perform a safe rescue the Fire Department or the Hydro Company should be called for assistance.

**2.03** Employees should become generally familiar with the types of construction used by the electric companies that operate in the localities where rescue work may be necessary so that they may be able to estimate the voltages of different types of circuits.

### 3. REMOVING EMPLOYEE FROM CONTACT WITH LIVE CIRCUIT OF LESS THAN 15,000 VOLTS

**3.01** In electric shock cases the rescuer should wear Insulating Gloves throughout the operations when he will be exposed to possible shock. If Insulating Gloves are not available, rescue work may be undertaken only if the contact can first be cleared by available safe means, such as by the use of a dry rope, dry board, dry tree pruner, dry ladder, or opening a switch. Men handling the rescue must keep cool, think clearly, and avoid impulsive and unsafe operations. Keep in mind the fact that wet ropes, wet wood and wet clothing are not safe insulators, and severe shock can be transmitted by them.

**3.02** When handling wires that may be "hot," use only one hand, in so far as practicable, and keep the other hand and other parts of the body clear of wires, guys, suspension strand, cable terminals or other grounded structures.

**3.03** If the reason for the high voltage being on the plant is evident, this contact should be removed, where practical to do so, without handling the supply conductors. In some cases it may be possible to clear the contact by throwing a dry hand line over the telephone or supply wires and pulling them apart or by pushing them apart with a ladder, or long dry stick, such as a tree pruner handle or pike pole. Do not use green wood or damp sticks in attempting to separate the wires and avoid standing on wet ground and in water.

**3.04** If methods mentioned above cannot be employed and if Insulating Gloves are worn, the contact between the supply wires and telephone conductors may be opened by cutting the telephone wires with pliers. A tree pruner with a dry pull rope may also be used, preferably with Insulating Gloves, for this purpose.

**3.05** Under extreme conditions, secondary electric circuits may be cut, provided that Insulating Gloves are worn while the wires are being cut. Do not attempt to cut a primary wire.

**3.06** In cutting supply wires or telephone wires that are crossed with electric supply wires, take a position so that the cut wires will not fly back or fall and injure the rescuer or other person. Turn the face away or close your eyes while cutting the wire to protect the eyes from the flash that may follow.

**4. REMOVING EMPLOYEE FROM CONTACT WITH LIVE CIRCUIT OF MORE THAN 15,000 VOLTS**

**4.01** If, in electric shock cases, the injured employee remains in contact with either charged telephone or power wires and, in the best judgment of the rescuer, the voltage involved is greater than 15,000 volts, the rescuer should, for his own protection, secure the assistance of a qualified employee of the power company to break the contact or open the switch, before proceeding with the rescue. This precaution is necessary since the Insulating Gloves are not designed to withstand these higher voltages and the rescuer cannot be sure that ropes, tree pruner handles, ladders and such equipment that might be used with Insulating Gloves are always dry enough to provide the degree of protection required.

**5. ASCENDING THE POLE**

**5.01** Keeping in mind the plan of rescue as developed in accordance with Part 2, proceed with the work.

**5.02** The rescue rope should be a rope in good condition, not less than 1/2 inch in size, and long enough to permit any available assistants on the ground to lower the victim. (A larger rope is preferable.)

**5.03** Push a loop formed near the end of the rescue rope under the body belt at the back so that it can conveniently be carried up the pole and removed when needed.

**5.04** Climb the pole on the selected side and get into proper position to work.

**5.05** While aloft, exercise every precaution to avoid contact with telephone wires, suspension strand, cable guys and other equipment, as well as contact with the body of the victim, unless it is clearly evident that the contact with the "hot" wire has been broken.

**5.06** If necessary, in order to facilitate lowering the victim, cut those telephone wires which would interfere. It is assumed, of course, that no wires will be cut which, in the planning of the rescue, it was concluded would be likely to cause the pole to fall. In cutting the telephone wires, exercise care to avoid dropping them on persons below. Be careful also that no projecting ends are left which might injure the victim while he is being lowered.

**6. REMOVING EMPLOYEE FROM CONTACT WITH WIRES AND LOWERING HIM**

**6.01** Pass the rescue rope over a crossarm or other attachment of suitable strength located above the employee. If working alone, take one complete turn of the rope around the crossarm or other fixture, so as to provide some snubbing action to assist in holding the victim's weight.

**6.02** Avoid direct contact with the victim until he is clear of the wires or other equipment that may be charged. When practical double back the end of the rope on itself and place the double rope end around the victim's body under the arms, and tie it either at the front or back with a bowline knot. (See Section 081-510-101). However, time should not be taken to double the end of the rope if it delays the rescue.

**6.03** If it will facilitate the rescue, pass the rope through the D rings of the victim's body belt and tie the rope securely, preferably in front.

## SECTION 010-100-012CA

If the rope is attached to his belt, exercise care in handling him so that the belt will not slip over his shoulders or down over his hips and cause him to fall. If necessary to move the employee to facilitate attaching the rope, this may be done by pulling on his safety strap.

**6.04** After the rope has been secured to the victim by either of the methods described in Paras. 6.02 and 6.03, pull him toward the pole by means of the rope or both the rope and the safety strap. If help is available on the ground, these assistants should be guided by the rescuer on the pole.

**6.05** When the preparations for lowering have been completed, unstrap or cut the em-

ployee's safety strap and lower him to the ground, guiding him when necessary, so that he will clear attachments on the way down.

### **7. ARTIFICIAL RESPIRATION AND OTHER FIRST AID**

**7.01** Immediately upon the victim's reaching the ground, remove the rope or body belt from his chest, so that it will not interfere with his breathing.

**7.02** *If normal breathing has stopped, apply artificial respiration immediately* and such other first aid as may be necessary, in accordance with the recommendations of the St. John Ambulance Association Textbook — Fundamentals of First Aid.

## FIRST AID

### RESCUE OF PERSON FROM LIVE WIRE ON GROUND

CONTENTS	PAGE
1. GENERAL . . . . .	7
2. PLANNING THE RESCUE . . . . .	8
3. FREEING PERSON FROM CONTACT WITH LIVE WIRE OF LESS THAN 15000 VOLTS .	8
4. FREEING PERSON FROM CONTACT WITH LIVE WIRE OF MORE THAN 15000 VOLTS .	9
5. ARTIFICIAL RESPIRATION AND OTHER FIRST AID . . . . .	9

#### 1. GENERAL

**1.01** This Section specifies methods of rescuing a person who is in contact with a live wire that is on the ground or at any location other than on a pole.

**1.02** This section is reissued to remove the reference to a specific page in First Aid Text Book which does not apply in the new book Fundamentals of First Aid and to add reference to Insulating Gloves.

**1.03** In an electric shock accident, *quick rescue and the prompt application of artificial respiration*, if normal breathing has stopped, are extremely important. In some cases the injured person may remain in contact with the wire because of his inability to let go of the line conductor or due to his being unconscious.

**1.04** An attempt to rescue a person from contact with a live wire is dangerous for anyone who does not understand how to proceed, because of the fact that the electric current may be carried through the body of the victim to the rescuer, or the live wire may come in contact

with the rescuer or other person and shock him, unless proper precautions are taken.

**1.05** If an unconscious person is in contact with a wire and it is not definitely known that the wire has been de-energized, *assume that it is a live circuit* in proceeding to clear him from contact with the wire. A broken live wire, when in contact with the ground may whip about until it obtains a good ground connection. Hence, it is always dangerous to move it even when all precautions are taken to prevent further whipping. Without loss of time and before removing either the person from the wire or the wire from the person, approach the wire from the side and drop a wooden object such as a crossarm, pike pole or tree pruner handle across the wire about 6 ft from the unconscious person, so as to hold the wire down. In approaching the wire, hold the wooden object vertically in front of the body and with the lower end close to the ground as protection against the wire coming in contact with the body due to unexpected whipping. Also, in removing the wire from the unconscious person it is definitely preferable to drag it from him with a wooden object over the wire than to lift it with a wooden object under it, so as to control movement of the wire to better advantage.

**1.06** In all cases where the victim is unconscious, call a physician to the location as soon as practicable, without delaying the rescue. After the victim has been removed from the contact, apply such first aid treatment as may be necessary in accordance with the recommendations of the St. John's Ambulance First Aid Text Book.

**1.07** Notify as soon as practicable the power company which operates the equipment involved in the accident.

**1.08** Review this practice and also the St. John's Ambulance First Aid Text Book at intervals, so that if it should become necessary to



## SECTION 010-100-013CA

rescue a person in contact with a live wire on the ground, the rescue work will be handled promptly and safely.

**1.09** For each power line operating voltage there is a corresponding smaller voltage between wires and ground. The likelihood of a telephone employee touching two wires of a power circuit is remote. Therefore, in case of personal contact, the voltage against which protection needs to be provided is the voltage to ground. In the following pages references are made to circuit voltage of 15,000 volts, corresponding to which the voltage to ground is 8,700 volts, against which Insulating Gloves in good condition provide positive protection.

### 2. PLANNING THE RESCUE

**2.01** Before starting the rescue, consider quickly but carefully, how the operation can best be carried out. The most important details to be considered are as follows:

- (a) Position of the injured person with respect to the conductor. His position will influence the method to be employed in clearing the contact, that is, whether to cut the wire, pull the wire clear of the victim, roll him off the wire or lift him clear of the wire.
- (b) Presence of a nearby switch by means of which the wire may be de-energized.
- (c) Rescue equipment available, such as Insulating Gloves, rubber footwear, pliers, dry rope, tree pruner handle, long-handled shovel, dry board, dry ladder, triangular bandage, or other non-conducting material that could be used for cutting or moving the wire or moving the victim.
- (d) Dependable assistants.
- (e) Probable voltage of circuit. (See Para. 4.01)
- (f) Presence of bystanders. It may be necessary to modify the rescue methods so that bystanders will not be injured by the energized wire while it is being handled.

**2.02** Men handling the rescue must keep cool, think clearly and avoid impulsive and unsafe operations. Keep in mind the fact that wet ropes, wet wood and wet clothing are not good

insulators and severe shocks can be transmitted by them. Avoid standing on wet ground and in water.

**2.03** Employees should become generally familiar with the types of construction used by the electric companies that operate in the localities where rescue work may be necessary, so that they may be able to estimate the voltages of different types of circuits.

### 3. FREEING PERSON FROM CONTACT WITH LIVE WIRE OF LESS THAN 15000 VOLTS

**3.01** In rescuing a person who is in contact with a live wire, always wear Insulating Gloves, if available. If rubber footwear is available, wear it, also.

**3.02** *If Insulating Gloves are available*, with or without rubber footwear, proceed in accordance with one of the following methods which are listed in their order of preference:

- (1) Pull the wire clear of the victim by means of a rope, or drag it clear with a tree pruner, board or ladder.
- (2) Cut the live wire on both sides of the victim by means of pliers or a tree pruner handle or on the remaining side if it is broken. In cutting the wire, close the eyes or turn the head away so that the eyes will not be exposed to the flash. **Warn bystanders to keep clear** so that they will not be injured by the ends of the wire after it has been cut. In many kinds of electric circuits, such as series street lighting circuits, voltage may remain on the wires after they have been cut at one place. If practicable, and if it will not delay the rescue operations, hold the wire down by means of a board or wooden tool handle before it is cut so that the wire ends will be under control.
- (3) Roll the victim off the wire. Observe the wire closely so as to avoid accidental contacts with it and prevent the ends from hitting bystanders.

**3.03** *If Insulating Gloves are not available*, extreme care must be exercised to avoid direct contact with the body of the person or with the live circuit. Use one of the following methods which are listed in their order of preference:

(1) Pull the wire clear of the victim by means of a *dry* rope, provided that it appears that the wire can easily be freed. A dry tree pruner handle may also be used in pulling the wire or cutting it clear. Do not under any circumstances use a wet rope or other wet materials that may come in contact with the live wire or the body of the victim.

(2) If the live wire cannot be freed readily by pulling it clear, slip a dry rope or other dry material under the shoulder or other part of the victim's body and roll him or lift him off the wire. A dry board, ladder, or dry stick may be used to assist in pushing the rope under his body, and then for dragging the wire clear.

(3) If the victim's clothing is wet, do not touch it under any circumstances unless Insulating Gloves are being worn. If his clothing is dry, it may be touched only if other dry insulating material is not available. In such a case, fold the dry insulating material before use so as to have a number of thicknesses between the hand and the clothing of the victim. Before grasping any part of the victim's clothing, touch it lightly with the back of the fingers to make sure there is no voltage on it. Preferably stand on a dry board or other insulating material while in contact with the clothing. Remember that under wet weather conditions

extreme care must be used to avoid shocks unless Insulating Gloves and rubber footwear or the equivalent are used.

#### 4. FREEING PERSON FROM CONTACT WITH LIVE WIRE OF MORE THAN 15000 VOLTS

4.01 If the victim is in contact with a live wire and in the best judgment of the rescuer, the voltage is in excess of 15000 volts, the rescuer should, for his own protection, secure the assistance of a qualified employee of the power company to break the contact before proceeding with the rescue. This precaution is necessary since the Insulating Gloves are not designed to withstand these higher voltages and the rescuer cannot be sure that ropes, tree pruner handles, ladders and such equipment that might be used with Insulating Gloves are always dry enough to provide the degree of protection required.

#### 5. ARTIFICIAL RESPIRATION AND OTHER FIRST AID

5.01 If normal breathing has stopped, *apply artificial respiration immediately* after the rescue. Follow the methods of applying artificial respiration, treating burns, treating physical shock, or giving other first aid recommended in the St. John's Ambulance First Aid Text Book.



PREVENTION OF SKIN IRRITATION  
FROM POISON IVY  
KERODEX 71 BARRIER CREAM

Contents	Page
1. GENERAL . . . . .	11
2. DESCRIPTION . . . . .	11
3. USE . . . . .	11
<b>1. GENERAL</b>	
1.01 This Section describes Kerodex 71 Barrier Cream and its use for skin protection.	
1.02 It is reissued to update information and to refer to Pentachlorophenol.	
<b>2. DESCRIPTION</b>	
2.01 The Barrier Cream is a substance which provides a protective coating for the skin to prevent irritation during some work operations.	
2.02 The creamy consistency permits it to be rubbed into the skin. It is insoluble in water.	
<b>3. USE</b>	
301. Barrier Cream is used to prevent skin irritation from poison ivy, cable plugging compounds, pentachlorophenol or coal tar pro-	

ducts. Before working where poison ivy or other skin irritant is suspected or known to be present, apply the cream to all exposed parts of the body.

**3.02** Exposed areas of the body from fingertips to elbows, ankles, legs up to the knees, and the face if necessary, should be thoroughly washed and dried before applying the cream. This should be done preferably in the morning before putting on the work clothes.

**3.03** Thoroughly cover the skin with the cream, and rub it into the skin. Wipe off any excess cream.

**3.04** If the hands and face are washed during the lunch hour, the cream must be re-applied. Care must be taken by those who are particularly susceptible to skin irritation to see that they are not subjected to re-exposure from contaminated clothing, as the oily substances can cling to clothes for some time.

**3.05** When any evidence of poison ivy or other irritation is noted, usually by an itching or redness of the skin, it should be reported immediately to the Supervisor.



**SCREWDRIVERS**

**SELECTION, USE AND MAINTENANCE**

	CONTENTS	PAGE
<b>1. GENERAL</b>		<b>13</b>
<b>2. B SCREWDRIVER</b>		<b>13</b>
<b>3. C, D AND E SCREWDRIVERS</b>		<b>14</b>
<b>4. SCREWDRIVER BIT</b>		<b>15</b>
<b>5. OFFSET SCREWDRIVER</b>		<b>15</b>
<b>6. USING SCREWDRIVERS</b>		<b>16</b>
<b>7. INSPECTION OF SCREWDRIVERS</b>		<b>17</b>
<b>8. STORING SCREWDRIVERS</b>		<b>17</b>
<b>9. REPOINTING C, D AND E SCREWDRIVER BLADES</b>		<b>17</b>
<b>10. STRAIGHTENING SCREWDRIVER SHANK AND BLADE</b>		<b>19</b>
<b>11. PRECAUTIONS</b>		<b>19</b>

**1. GENERAL**

**1.01** This section covers the use, general handling precautions, care and maintenance of standard Bell System screwdrivers and the screwdriver bit.

**1.02** This section is reissued to cover the plastic-handled Phillips Type B screwdriver and the C, D and E screwdrivers with tougher and longer life blades and plastic handles. Since this reissue covers a general revision, arrows ordinarily used to indicate changes have been omitted.

**1.03** The C, D and E screwdrivers replace the previous standard 3- and 6-inch cabinet, H cabinet, and 4- and 5-inch regular wood-handled screwdrivers. The use and maintenance of the wood-handled screwdrivers still used in the field are the same as covered herein.

**1.04** Screwdrivers that are designed for special purposes such as offset screwdrivers, cord repair, etc, should be replaced when they become worn or defective.

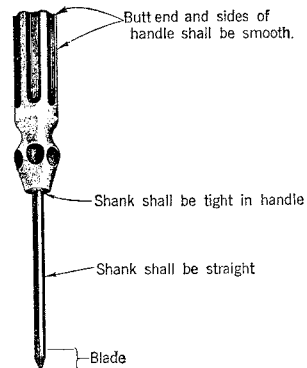
**1.05** The screwdrivers provided for use in the Bell System are high-grade tools. The blade tips are specially ground to fit the screws ordinarily used in telephone work. The B, C, D and E screwdrivers consist of fluted transparent amber-colored plastic handles pressed on the tangs which are forged in one piece with the heat-treated alloy steel blades. These screwdrivers may be furnished with a 4- or 6-fluted plastic handle.

**1.06** *Screwdrivers are intended for use in turning screws and not for use as drills, chisels or pinch bars.*

**2. B SCREWDRIVER**

**2.01** Fig. 1 illustrates the B screwdriver and indicates the condition in which screwdrivers of this type shall be maintained for safe and satisfactory service. This screwdriver is furnished in three sizes as shown in the table in Paragraph 2.02. It is for general use with cross-recessed head screws of the Phillips type.

TYPE B



**Fig. 1**

**2.02** The following is a table of the sizes of B screwdrivers, their over-all lengths, and the sizes of screws that are accommodated by each screwdriver. Select the proper size of screwdriver for each type of screw.

SIZE No.	OVER-ALL LENGTH In.	SIZE OF SCREW No.
1	7	4 and smaller
2	8	5 to 9
3	11	10 to 16

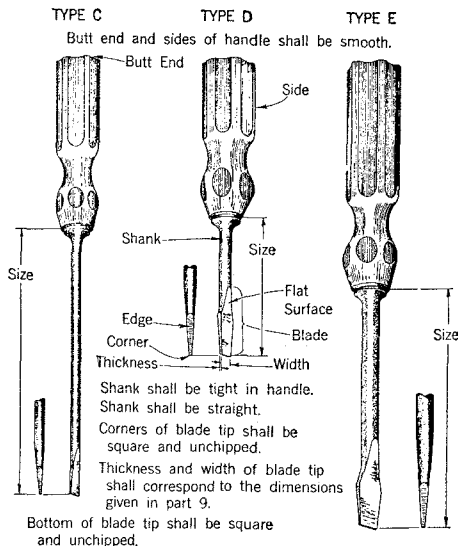
**2.03** It is not feasible to repoint the blade tip of the B screwdriver in the field since it is formed of curved surfaces which cannot be restored readily by filing. Careful storage and use of this screwdriver by squaring the blade tip in the cross-recessed slots of the proper size screws will result in its maximum safe and efficient usage. When the blade tip becomes inefficient or hazardous by wear or defect, it should be marked defective and exchanged for one in good condition.

**3. C, D AND E SCREWDRIVERS**

**3.01** Fig. 2 illustrates the C, D and E screwdrivers and indicates the condition in which screwdrivers of these types should be maintained for safe and satisfactory service. These screwdrivers are furnished in three types designated C, D and E in the sizes as shown in the table in Paragraph 3.02. The two C screwdrivers are for light duty on small screws used principally in apparatus assemblies. The two E screwdrivers are for general use on the larger wood and machine screws used in making plant attachments. The D screwdriver is a combination of features of the C and E types for use on an intermediate range of screw sizes.

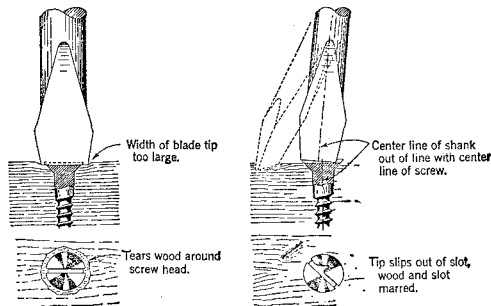
**3.02** The following is a table of the sizes of C, D and E screwdrivers, their over-all lengths, and the range of sizes of screws that are accommodated by each screwdriver. Select the proper size of screwdriver for each size of screw. Wherever practicable, select the D or E type screwdriver for turning in wood screws.

TYPE	SIZE In.	OVER-ALL LENGTHS In.	SIZE OF SCREW No.
C	3	6-7/8	4 to 6
C	6	9-7/8	5 to 8
D	3	6-1/2	5 to 10
E	4	8-5/16	6 to 12
E	5	10-1/2	14 to 18



**Fig. 2**

**3.03** Figs. 3 through 7 illustrate what is likely to occur if a screwdriver is not maintained in good condition, is of the wrong size, or is improperly used. These conditions promote neither safety nor satisfactory workmanship. Also, screws with damaged slots are difficult to remove.



**Fig. 3**



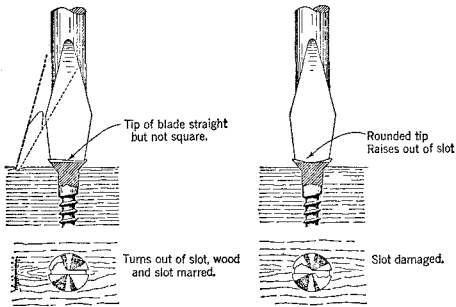


Fig. 4

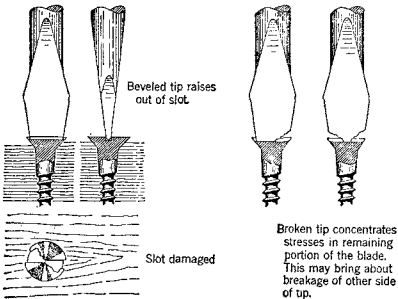


Fig. 5

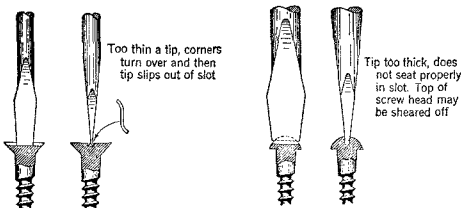


Fig. 6

Bent shank throws screw out of line, causing point to break out of hole.

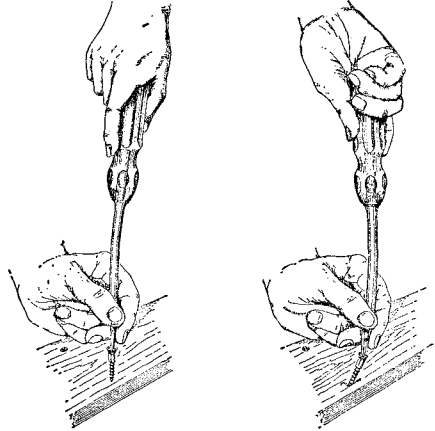


Fig. 7

**4. SCREWDRIVER BIT**

**4.01** The screwdriver bit, illustrated in Fig. 8, is provided for use where a considerable number of the larger screws are to be placed or removed and a brace is available.

**4.02** The sizes of screws recommended for use with the screwdriver bit range from No. 10 through No. 18.

**4.03** The blade tip of this screwdriver shall be repointed, when required, in accordance with Part 9 of this Section.

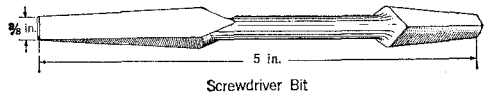


Fig. 8

**5. OFFSET SCREWDRIVER**

**5.01** The offset screwdriver, illustrated in Fig. 9, has either one or two blades which project at a right angle to the handle or shank. The angles, however, that are listed in the Bell System Practices for the various types of offset

SECTION 075-160-301CA

screwdrivers are determined by the angle formed by the face of the blade and the handle (Fig. 9 illustrates a 90° offset screwdriver).

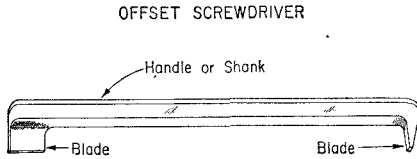


Fig. 9

6. USING SCREWDRIVERS

6.01 In general, a lead hole will not be required for starting the smaller sizes of screws in soft wood. Lead holes of the following sizes shall be made for the larger sizes of screws where such holes are not already available. An automatic drill or a hand drill equipped with twist drills has been found satisfactory for this work.

SIZE OF WOOD SCREW		SIZE OF DRILL POINT
HARD WOOD	*SOFT WOOD	
	No. 6	1/16 Inch
No. 6	No. 8 to No. 10	3/32 Inch
No. 8 to No. 10	No. 12 to No. 14	1/8 Inch
No. 12 to No. 18	No. 18	11/64 Inch

\* Use this table for outside attachments.

6.02 After lead hole has been drilled insert the screw and start it by holding it and the screwdriver in position as shown in Fig. 10.

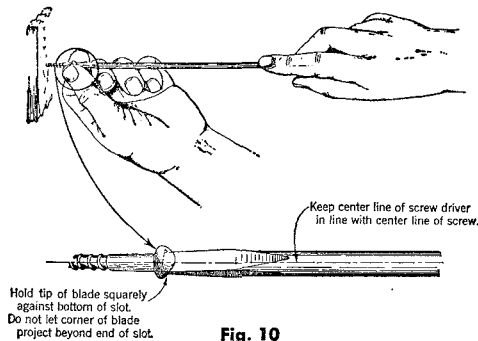


Fig. 10

6.03 Turn the screw, keeping the center line of the screwdriver in line with the center line of the screw. Hold the tip of the blade squarely against the bottom of the screw slot in order to prevent damaging the screw. Use two hands when starting screws, one on the handle of the screwdriver to do the turning and the other on the blade to steady it on the screw. Avoid injury by keeping the head and arms in such a position that they will not be struck with the tip should the screwdriver slip. Remember that the tip of the blade will have the greatest tendency to slip out of the screw slot just before each turn is completed, especially the last turn.

6.04 When turning screws in hard wood, lubricate the threads with a small amount of soap or beeswax, taking care, particularly in hot weather, that the lubricant does not enter the slot of the screw or coat the screwdriver tip. It is difficult to keep the tip of the screwdriver engaged with the screw slot if either the blade or the slot is lubricated. Such a condition may be the cause of an accident and, therefore, if lubricant is found at these points it shall be removed before turning the screw.

6.05 When using an offset screwdriver, the tip of the blade should rest flush with the bottom of the slot in the screw. If room permits, apply pressure on the shank or handle directly above the screw in order to hold the tip of the blade firmly in place while the pressure is applied for the swinging motion. If there is not enough space to apply the pressure directly over the screw it should be applied to the handle as near as possible to the screw head.

6.06 When the swinging space of the offset screwdriver is limited, it may be necessary to reverse the ends of the screwdriver after each swing. If the screw cannot be turned in this manner, two offset screwdrivers with blades at different angles may be used.

**Caution:** Care should be taken while using offset screwdrivers so as not to injure the fingers or hand or burr the head of the screw by the blade slipping out of the slot of the screw.

## 7. INSPECTION OF SCREWDRIVERS

**7.01** Each employee, on receipt of and at frequent intervals thereafter, shall make an inspection of the screwdriver in accordance with Paragraph 7.04, in order to determine whether any fault has developed.

**7.02** Each employee shall at all times assume the responsibility of determining that the screwdriver is in good condition and that its appearance does not indicate injury or defects sufficient to impair its usefulness.

**7.03** Screwdrivers shall be checked periodically and the employee performing this work shall see that all instructions contained herein are complied with.

**7.04** Screwdrivers should be examined to determine their condition as suggested below. In connection with the inspection of screwdrivers the important conditions to look for are:

- (a) \*Handle broken, split, cracked or rough on sides or butt end.
- (b) Blade loose in handle.
- (c) Blade broken.
- (d) Soft tip (temper destroyed).
- (e)\*\*Blade bent. (See Part 10.)
- (f)\*\*Point of tip chipped, worn or improperly shaped. (See Part 9.)

\*The plastic handles are tough and resistant to breakage, splitting and cracking. However, any roughness on the handle may be made smooth by sanding so as to avoid irritation to the hand.

\*\*When conditions (e) and (f) are found they shall be corrected in accordance with Parts 9 and 10. A screwdriver with an improperly shaped tip that cannot be readily sharpened in the field, or one with the blade excessively bent, shall be exchanged for one in good condition.

**7.05** If any of the conditions under (a), (b), (c) or (d) are found to exist or if the condition of the screwdriver is such that there is any doubt

as to its serviceability, it should be marked defective and exchanged at once for one in good condition in accordance with the established routine.

## 8. STORING SCREWDRIVERS

**8.01** New screwdrivers shall be left in the original package until required. Screwdrivers which have been issued should be placed in a locker or container provided for the purpose when not in use. Never place a screwdriver in such a position on shelves that persons passing by are likely to scratch themselves on the protruding tip or, in such a way that the screwdriver may roll off and create a hazardous condition or strike someone. Screwdrivers shall be kept in tool rolls or other approved carrying cases or suspended from brackets provided in the compartments of a truck for this purpose when not in use. When suspended from brackets, screwdrivers shall be stored with blade downward.

## 9. REPOINTING C, D AND E SCREWDRIVER BLADES

**9.01** The screwdriver blade tip shall be kept properly shaped at all times. The following method has been found satisfactory for repointing the tip:

(a) Select one of the types of files provided for sharpening tools. If the teeth of the file are clogged, clean them before using the file. This can be readily done with the standard carding brush or by pushing the end of a copper strip (a small piece of copper strip of the ground wire clamp is suitable) across the file in line with the cutting edges of the teeth.

(b) Select such a location for performing the work that the elbows will be level with the object to be filed. A flat surface should be sought as this can be used as a guide in determining whether the file is being pushed straight across the object.

(c) For squaring the tip of the blade, hold the screwdriver blade at a right angle to a flat surface (floor of truck, top of box or workbench) using index finger to steady it, as shown in Fig. 11.

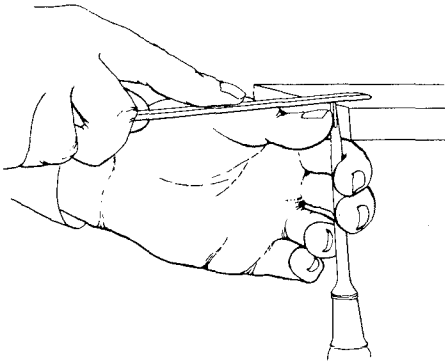


Fig. 11

Place the file parallel with the flat surface and at a slight angle (approximately 20 to 30 degrees) to the center line of the surface to be filed. Grasp the file securely so that it can be easily steadied and its movement controlled at all times. Move the file forward and parallel to the flat surface, applying sufficient pressure for the teeth to grasp the metal. The pressure should be evenly distributed and maintained throughout the forward stroke. On the return stroke, the file should be held slightly above the surface being filed in order not to dull the cutting teeth. Continue filing until broken, chipped or rounded edges have been removed.

(d) With the screwdriver and file held in a position similar to that illustrated in Fig. 12, dress down the edges of the tip, restoring the width of the point to its original size as closely as practicable.

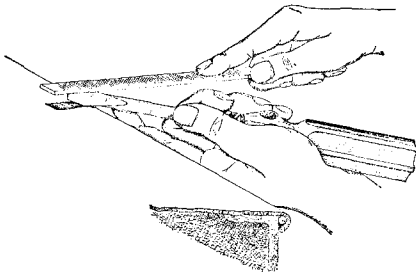


Fig. 12

(e) With the screwdriver and file held as shown in Fig. 13, file the entire broad flat face of the tip until the following dimensions, with regard to thickness of point, are obtained. The slots of the screws listed in the following table may be used as gauges for determining the thickness of the point desired. This method of gauging is only an approximation of the dimensions given, so that when screws having smaller slots than those used for gauging are encountered they shall be adopted as the gauges.

SCREWDRIVER		POINT DIMENSIONS		SIZE OF FLAT HEAD SCREW SLOT TO BE USED AS GAUGE
TYPE	SIZE	THICKNESS	WIDTH	
C	3 in.	.025 in.	3/16 in.	No. 4 Wood Screw
C	6 in.	.028 in.	3/16 in.	No. 5 Machine Screw
D	3 in.	.029 in.	1/4 in.	No. 5 Wood Screw
E	4 in.	.031 in.	1/4 in.	No. 6 Wood Screw
E	5 in.	.043 in.	7/16 in.	No. 14 Galv. Wood Screw
Screwdriver Bit				No. 14 Galv. Wood Screw

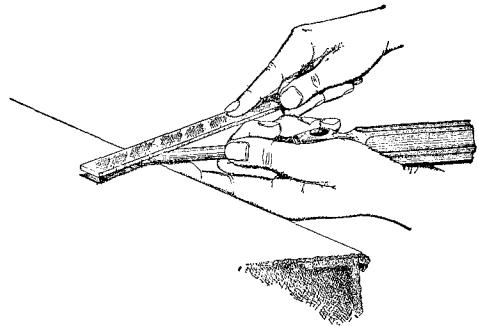


Fig. 13

**9.02** *Never use an emery wheel for repointing a screwdriver blade. Heat generated by its use may destroy the blade temper.*

## 10. STRAIGHTENING SCREWDRIVER SHANK AND BLADE

**10.01** The shank and tip of a screwdriver blade shall be kept straight. If the blade is bent and a vise is not available, straighten it by placing the bent portion on a solid flat surface with the tip and the portion of the shank near the handle resting on the flat surface. With the screwdriver in this position, strike the curved section near the handle lightly with a hammer. Repeat, striking a little ahead of the last blow until the tip is reached. These operations should be followed until the shank is flush with the flat surface. Blades bent excessively shall not be straightened.

**10.02** To straighten a bent shank and blade with a vise available, place the shank of the screwdriver in the vise in a horizontal position. The point where the bend starts should be just outside the jaws of the vise. The shank should be parallel with the top of the workbench on which the vise is mounted. Apply pressure at the handle or shank in a direction that will tend to straighten out the bent portion. If the bent portion is such that one operation does not entirely straighten the shank, reposition the screwdriver in the vise as the portion nearest the vise becomes straight. Continue in this manner until the entire shank is straight.

## 11. PRECAUTIONS

**11.01** Do not use a screwdriver as a drill, chisel or pinch bar.

**11.02** Do not stick a screwdriver in either the flame of a furnace or torch, or a pot of hot solder, as this will destroy the temper of the tool. Never use a screwdriver as a substitute for a soldering copper.

**11.03** Use the size of screwdriver with the sizes of screws for which it is intended.

**11.04** Do not use a screwdriver with broken, chipped or rounded tip.

**11.05** Do not carry screwdrivers in pocket where injury may result through exposure of the tip of the blade.

**11.06** Do not use screws with damaged slots. Burred screw slots often cause the screwdriver to slip, resulting in accidents.

**11.07** Do not work with the screwdriver in such a position that if it slips it will cause injury, particularly in the area of the hands, face or eyes. If it is necessary to hold small objects in which screws are to be placed or from which they are to be removed, the hand should be kept away from the back of the object so that it will not be struck if the screwdriver slips. This can usually be accomplished by placing the object against some supporting surface—*avoid holding small objects in the palm of the hand.*



## GROUNDING PORTABLE ELECTRIC POWER TOOLS

### 1. INTRODUCTION

This section describes the proper grounding of portable electric power tools and methods of obtaining effective grounds.

### 2. GENERAL

**2.01** The grounding of portable electric tools protects the operator from electric shock caused by insulation breakdown on current-carrying parts within the tool housing. Grounding prevents the appearance of voltage on the frame of the tool.

**Note:** Tools operated from ungrounded portable electric generators (circuit isolated from ground) and ALL-INSULATED tools do not require grounding. ALL-INSULATED tools are completely enclosed in a tough insulating plastic housing and do not require any grounding. Since there are many partially insulated tools on the market it is important for your safety to use only ALL-INSULATED tools which have been approved for use in Bell Canada.

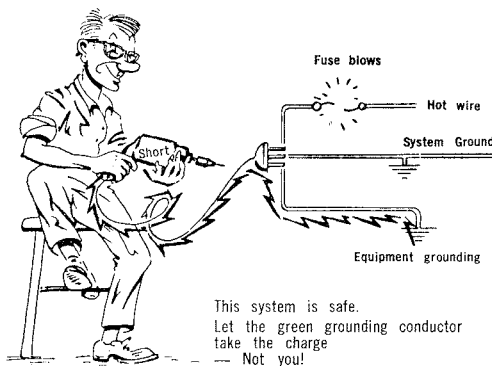


Fig. 1

**2.02** Grounding, as described in this section, is accomplished by a third conductor used to connect the tool housing to the local power grounding system or to other equivalent grounds such as a cold water pipe. (See Figs. 1 and 2)

**2.03** Permission should be obtained from the property owner or an authorized person before connecting power tool to outlet receptacles on a customer's premises.

### 3. CAUTIONS

**3.01** Use only electric tools provided by the telephone company.

**3.02** Electric power tools should always be grounded except as noted in Para. 2.01. Take special care to ensure that this grounding is adequate (See Parts 4 and 5).

**3.03** Before connecting a tool to a power supply, check the apparatus plate on the tool to be certain that the proper voltage and type of current (ac or dc) is available.

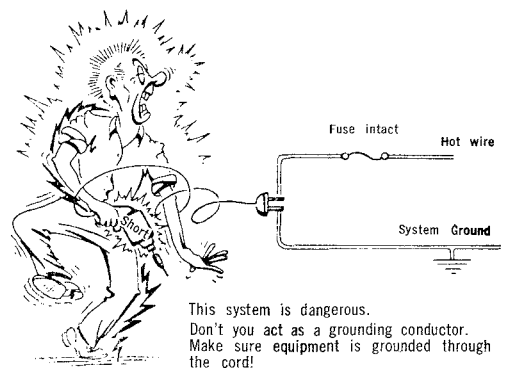


Fig. 2



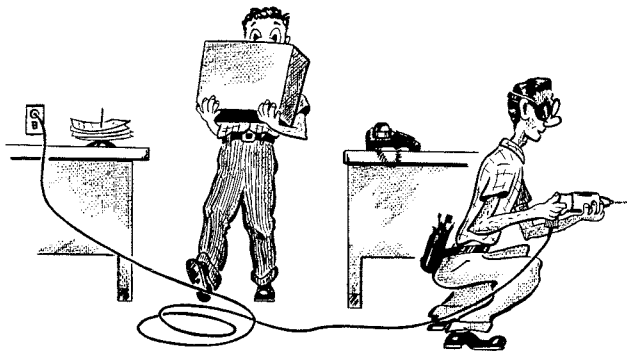


Fig. 3

- 3.04 Replacement cords should have equal or larger gauge wire than the original cord.
- 3.05 All cords assembled or repaired locally should be tested for continuity of the grounding conductor before connecting the tool to a power supply. Periodic testing of the grounding conductor should be followed in accordance with local procedures.
- 3.06 Make certain that the grounding connections do not become disengaged during the operation of the tool.
- 3.07 A power tool, even when grounded, must not be used while the operator is standing in water.

- 4.03 3-Conductor extension cords are required for connecting power tools to outlet receptacles remotely located from the work area. These are 25 ft. cords with 3-Conductors (#16 AWG) having standard plugs (U-Ground) at one end and U-Ground receptacles at the other.

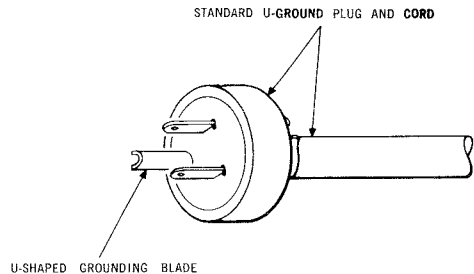


Fig. 4 — Standard U-Ground Plug

4. PROVISIONS FOR GROUNDING

- 4.01 All electric power tools except lamps, soldering coppers and ALL-INSULATED tools, must be equipped with a 3-Conductor cord which terminates in a U-Ground plug. (See Fig. 4).

- 4.02 Except for the tools mentioned in Para. 4.01, the U-Ground plug is currently furnished as standard equipment with all Bell Canada tools. If commercial power receptacles of the 2-Conductor parallel or crowfoot types are encountered on the customer's premises, one of the appropriate adapters shall be used. (See Fig. 5)

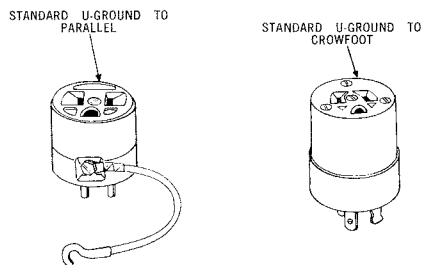


Fig. 5 — Adapters

5. METHOD OF GROUNDING

3-Conductor Grounding-Type Receptacles

5.01 The most satisfactory method of providing an effective ground is through the connec-

tion of a U-Ground plug to a comparable U-Ground receptacle (See Fig. 6). If outlet has a crowfoot or 2-Conductor parallel receptacle, use appropriate adapter. (See Fig. 5).

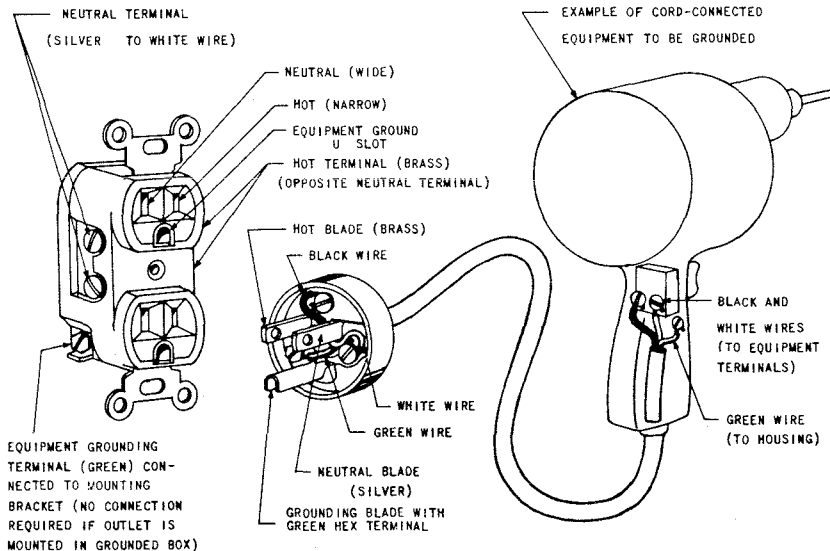


Fig. 6 – Typical Bell Canada Arrangement

2-Conductor Receptacles (Ungrounded Outlet Box)

5.02 Where electrical connections are to be made at 2-Conductor parallel ungrounded receptacles, the pigtail grounding wire or ground terminal must be connected to a suitable ground. This is accomplished as follows:

- Locate a nearby grounded object, such as a cold water pipe, to which the ground wire or grounding cord may be attached.
- Attach, between ground terminal on adapter and grounded object selected, a ground wire (See Fig. 7), making certain a good metallic connection at both ends is accomplished.

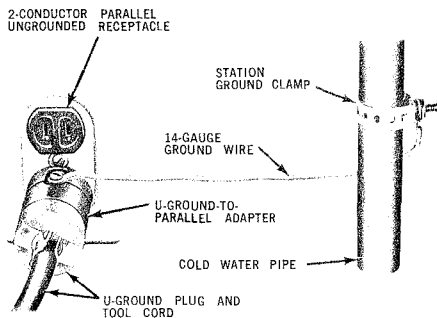


Fig. 7 – Ungrounded 2-Conductor Receptacle

- If grounded object selected is far away from power outlet use the B Grounding Cord to connect the object to the ground pigtail wire on the adapter (See Fig. 8).

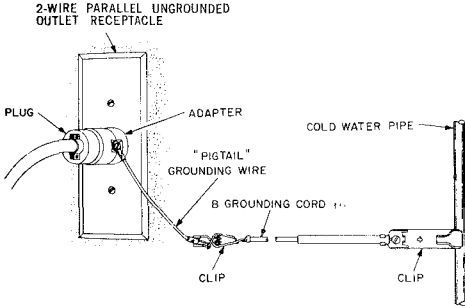


Fig. 8 – Grounding Pigtail

- The B Grounding Cord is a 15-foot, 18 AWG, Single conductor cord with clips at both ends (See Fig. 9).

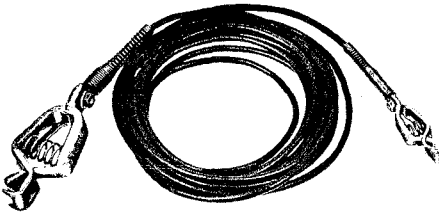


Fig. 9 – B Grounding Cord

2-Conductor Receptacles – (Grounded Outlet Box)

- 5.03 Where it is known that a building is wired with metallic conduit, armored cable, or

nonmetallic sheath cable with a grounding conductor, the outlet boxes may be grounded. Under these conditions and only after it has been found that the boxes are grounded, the grounding pigtail terminal on the adapter or plug may be fastened under the coverplate screw of the receptacle. (See Fig. 10).

- 5.04 In grounding to a 2-Conductor receptacle (Fig. 10), connect pigtail to coverplate screw before inserting adapter into the receptacle.

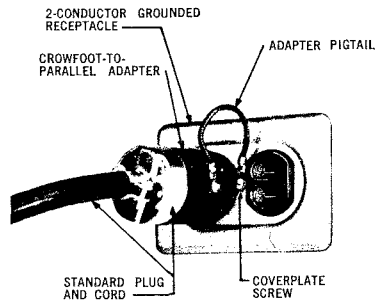


Fig. 10 – Grounded 2-Conductor Receptacle



*If grounding cannot be accomplished as outlined in this section, the electric tool must not be operated. Nonelectric tools should be used to complete the job.*

## ATTACHMENTS, FASTENERS, AND METHODS FOR RUNNING INSIDE WIRE AND CABLE

### 1. INTRODUCTION

1.01 This section identifies fasteners and methods generally employed in the installation of station wire, ground wire and inside wiring cable in or on buildings.

1.02 This section is reissued to revise para. 3.03, Table B, and to incorporate supplement.



*“Do not place Anchors or drill holes in Precast or Prestressed Concrete without obtaining permission from the Building Owner or the Architect”. Anchors or Holes in unauthorized locations could seriously weaken the Building Structure.*

### 2. GENERAL

2.01 Additional detailed information on methods for running station wire may be found in section entitled, “Selection of Route for Station Wire and Cable”.

### 3. FASTENERS FOR STATION WIRE AND CABLE

3.01 When selecting station wire and cable fasteners:

- Use galvanized fasteners outdoors or where appearance is unimportant.

3.02 A cable clamp and a cable clasp are shown in Fig. 1. Table A indicates the fasteners to be used to attach cable clamps and cable clasps to various surfaces.

- Cable clamps and cable clasps are used for fastening cable or more than one station wire.

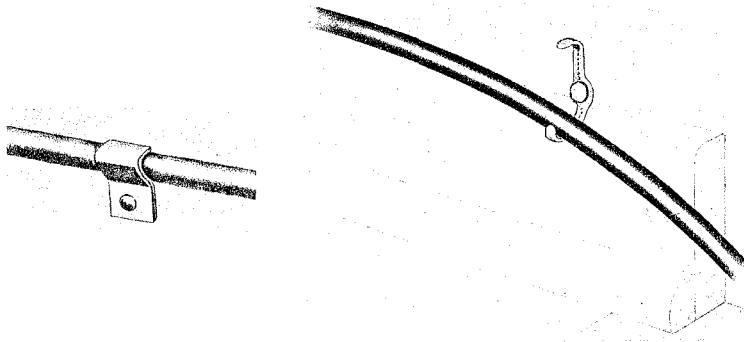


Fig. 1 — Cable Clamp and Cable Clasp

**TABLE A**  
**FASTENERS FOR CABLE CLAMPS AND CABLE CLASPS**

Surface	Clamp No.	Clasp No.	Fastener	Remarks
	Colour			
	Grey Galvanized	Grey		
Woodwork	3 and 5	7	1-1/2 in. No. 6 RH wood screw or 1/2-in. inside wiring nail in hardwood or 7/8-in. inside wiring nail in softwood	No. 8 RH wood screws cannot be used without reaming the screw hole.
Woodwork Plaster on Wood Lath Plasterboard	6, 8, 10, 12 30 and 38	9 and 14	1-1/2 in. No. 8 RH wood screw	Inside wiring nail may be used to attach No. 9 clasp to wood.
Plaster on Wood Metal Lath, Plasterboard, Metal Sheathing	3 and 5	7	7/8-in. inside wiring nail or 3/8- or 5/8-in. No. 6 self-tapping screw in metal	Place fasteners at stud locations or in solid wood backing.
Metal Sheathing	6, 8, 10, 12 30 and 38	9 and 14	3/8- or 5/8-in. No. 8 self-tapping screw in metal or 1-in. roofing nail	No. 8 RH wood screws cannot be used without reaming the screw hole. No. 6-D slating nail may be used to attach No. 9 and 14 clasps to studding if baseboard is not wood.
Plaster on Masonry	3 and 5	7	1-1/2 in. No. 6 RH wood screw in 1-1/2 in. No. 6-8 screw anchor.	
Plaster Block	6, 8, 10, 12 30 and 38	9 and 14	2-in. No. 8 RH wood screw in 1-1/2 in. No. 6-8 screw anchor.	
Masonry	3 and 5	7	1-in. No. 6 RH wood screw in 3/4-in. No. 6-8 screw anchor	No. 8 RH wood screws cannot be used without reaming the screw hole.
	6, 8, 10, 12 30 and 38	9 and 14	1-in. No. 8 RH wood screw in 3/4-in. No. 6-8 screw anchor	A 3/16- by 7/8-in. hammer drive anchor may be used with No. 6, and 8 cable clamps.

*Notes 1:* Washers are required under head of screw when No. 30 and 38 cable clamps are used.

*2:* Use galvanized screws for galvanized clamps. For No. 30 and 38 clamps use No. 10 RH galvanized wood screws and No. 10-14 screw anchors.

**3.03** Staples used for fastening inside wire and cable have a galvanized finish which provides resistance to rust and corrosion. (See Fig. 2 and Table B.)

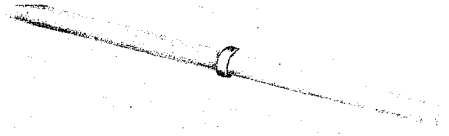


Fig. 2 — Staple

**TABLE B**  
**SELECTION OF STAPLES**

Staple	Colour	Stapler	Remarks
3/8 in.	Galvanized Finish	Stapler Z	Used in soft and hard wood.
3/8 in.	Galvanized Finish	Arrow T-25	Used in hard wood.
7/16 in.			Used in soft wood.
9/16 in.	Galvanized Finish	Stapler Y	Used in soft and hard wood.
7/8 in.			Used in very soft wood.

**Note:** Staples are not recommended for use in plaster.

**3.04** *B Insulator Support* (Fig. 3)

- This support is used to fasten station wire and cable on metal structures.
- It may be equipped with M Bridle Rings.

**3.05** *The B Support Clip* (Fig. 4): provides a means of attaching Drive Rings to hanger rods and wires used in false ceiling construction or to the flanges of structural steel framework. It replaces the B Beam Clip.

**3.06** This notched spring steel clip has two loops which will retain Drive Rings. In addition there are thread impressions for No. 1/4"-20 or No. 10-24 screw.

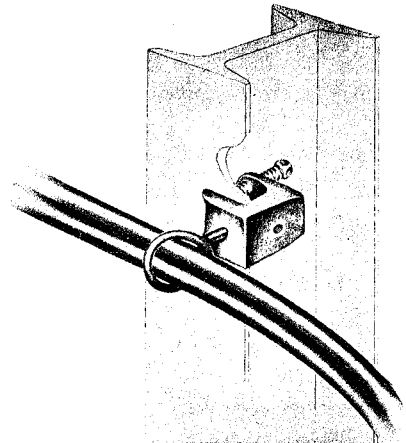


Fig. 3 — B Insulator Support

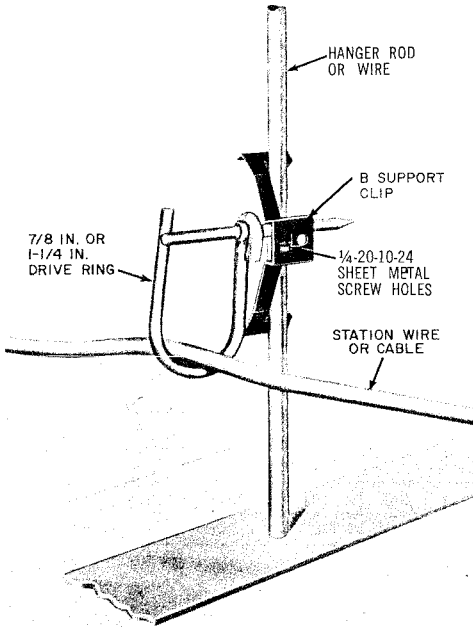
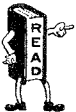


Fig. 4 - B Support Clip

3.07 This clip can be installed on the following:

- Beam Flanges from 1/8" to 3/8".
- Wire from No. 12 to No. 8.
- Rod 3/16" to 3/8" in diameter.



*The B Support Clips are intended for Inside use only.*

3.08 Drive Rings (Fig. 6)

- Install rings on brick or masonry surfaces with hammer drive anchor as indicated in Fig. 6A.
- Install drive rings in wood surfaces as indicated in Fig. 6B.

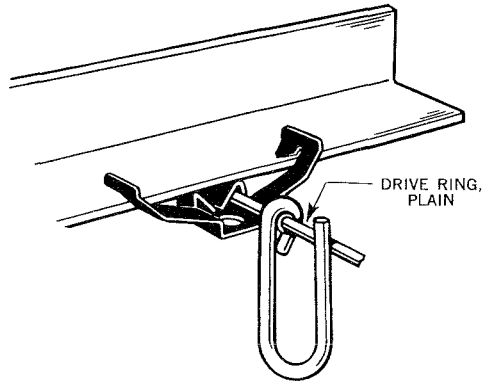


Fig. 5

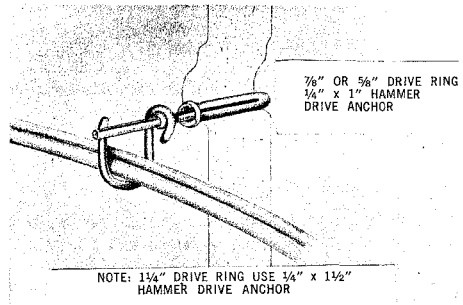


Fig. 6A - Drive Rings

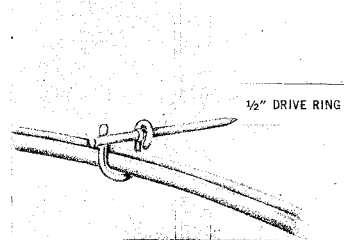


Fig. 6B - Drive Rings

**TABLE C**  
**CAPACITY OF FASTENERS FOR CABLE**

Size of Cable Pair	Clamp No.		Clasp No.
	Galvanized Cable Clamps For Cable	Grey	Grey
6	14	5	7
11	17		
12		6	7
16	18	8	9
21	24	8	9
25	24	8	9
31	24		
50	30	12	14
75	30	12	14
100	38		

Capacity of fasteners for cable and station wire is indicated in Tables C and D.

**3.09** *The wall screw anchor* (Fig. 7) is used for attaching various items of station apparatus, inside wire, and cable to interior wall surfaces of hollow construction. They can be used in plywood, wallboard, masonite, and hollow plaster wall.

- To obtain maximum holding power, the wall thickness should first be determined and then the correct size anchor should be selected. (See Table E for selection.)



**Fig. 7 – Wall Screw Anchor**

**3.10** To install a wall screw anchor after the proper anchor has been selected, proceed as follows:

- Mark spot where anchor is desired.
- Drill hole in wall corresponding to diameter of anchor body (see Table E).

**TABLE D**  
**CAPACITY OF FASTENERS FOR STATION WIRE**

Type of Wire		Capacity								
		Clamp No.						Clasp No.		1/2-in. Drive Rings
		3	5	6	8	17	10	7	9	
Z Station	Quad *	2	3	5	8	5	10	10	17	15
Z Block	Paired				5	4				4
	Triple				4	3				3

\* The Z Station Wire Clamp is used to clamp a single Z Station Wire.

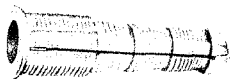


**TABLE E**  
**SELECTION OF WALL SCREW ANCHORS**

Code of Anchor	Wall Thickness	Anchor Lengths	Drill Diameter
Dimensions in Inches			
1	Up to $\frac{5}{8}$	$1\frac{1}{2}$	$\frac{5}{16}$
2	$\frac{5}{8}$ to $1\frac{1}{4}$	$1\frac{7}{8}$	$\frac{5}{16}$
3	$1\frac{1}{4}$ to $1\frac{3}{4}$	$2\frac{1}{2}$	$\frac{5}{16}$
4	Up to $\frac{5}{8}$	$2\frac{1}{4}$	$\frac{7}{16}$
5	$\frac{5}{8}$ to $1\frac{1}{4}$	$2\frac{3}{4}$	$\frac{7}{16}$
6	$1\frac{1}{4}$ to $1\frac{3}{4}$	$3\frac{1}{2}$	$\frac{7}{16}$

The 1, 2, 3 type wall screw anchors are for light loads and the 4, 5, 6 type for heavy loads.

- (c) Insert anchor, and tap anchor gently until cap prongs are imbedded and cap is firmly set against wall surface.
- (d) Tighten screw while pressing firmly in order to prevent anchor from rotating.
- (e) In soft-textured walls it will be necessary to hold the anchor body from rotating while turning the screw until the anchor is in its fully expanded position.
- (f) When anchor is fully expanded, remove screw and attach hardware. (There is some resistance to turning the screw when the anchor is fully expanded.)
- (g) Hold equipment in position; replace screw and tighten.

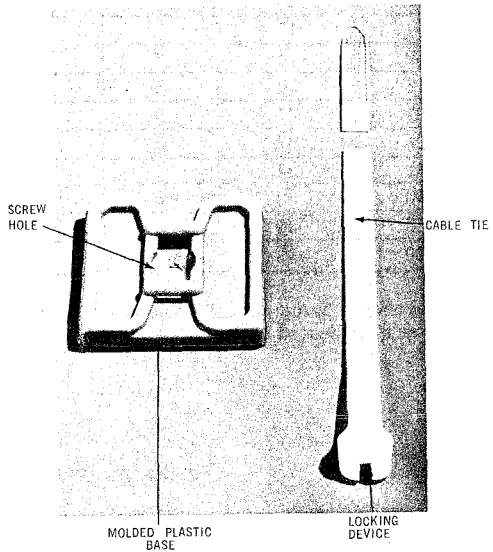


**Fig. 8 – Typical Plastic Anchor**

**3.11 The Plastic Anchor** is intended for use with wood screws when making attachments to masonry, brick or concrete, (see Fig. 8.) See shipping carton for size of anchor, hole and screw.

**3.12 The Adhesive Cable Tie** (Fig. 9) is intended for use in customer telephone installations to group wires, cords, and inside wiring cables in an orderly harness.

**3.13** The adhesive cable tie is a molded plastic base available in grey only. The cable tie is used to secure the wires or cables to the base.



**3.14 INSTALLATION PROCEDURES**

- (a) The adhesive cable tie is intended to be used to fasten wires, inside wiring cables and cable connectors on metal partitions, metal furniture, terrazo and marble.
- (b) The adhesive base should be applied to a surface that is free of grease, loose paint, wax and moisture.

(c) Space the adhesive cable tie as required and mount the adhesive base by using the self adhesive backing. If a more secure mounting is required a self tapping screw or a wood screw may be used in the hole provided in the base.

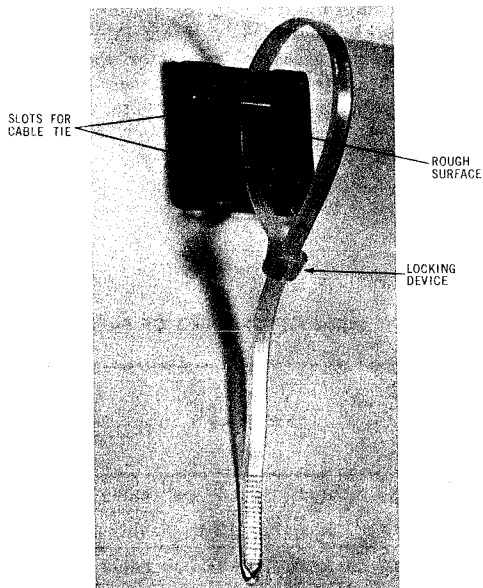
(d) To mount adhesive base remove paper coating from adhesive and apply firmly to surface.

(e) Place the cable tie with the rough surface outward in the two slots provided from the bottom to the top of the base. (See Fig. 10).

(f) Place cable tie over wires or cables and thread end of tie into locking device. (See Fig. 10).

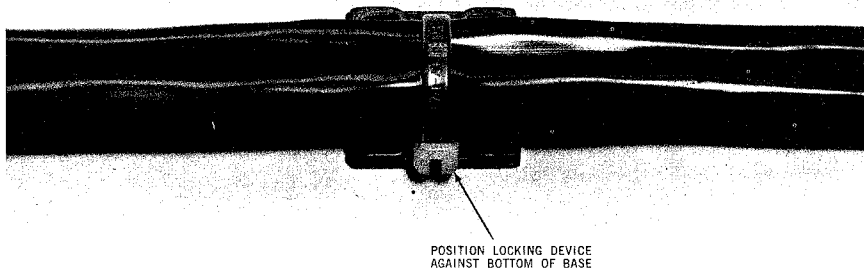
(g) Pull cable tie tightly around cable and cut off the excess cable tie as close as possible to the locking device.

(h) Position cable tie as shown in Fig. 11.



NOTE - CABLES OMITTED FOR CLARITY

**Fig. 10**  
**Adhesive Cable Tie Equipped with Cable Tie**



**Fig. 11 — Adhesive Cable Tie and Cable Tie with Cables Attached**

**3.15 Spacing of fasteners for station wire and cable** is indicated in Table F. Where appearance is not a controlling factor, the spacing between the fasteners may be increased. If wire must be run across joists in cellars, fasten to each joist with staples or to every other joist when using drive rings.

#### 4. SIZES OF HOLES FOR STATION WIRE AND CABLE

**4.01** Tables G and H indicate the sizes of holes needed to accommodate various types and numbers of station wires and cables.

**TABLE F**  
**SPACING OF FASTENERS FOR STATION WIRING AND CABLE**

Fasteners		Spacing				
		Horizontal Run		Vertical Run		From Corner
		inches	feet	inches	feet	inches
Cable Clamps	more than 12-pair cable	16			4	2
	less than 12-pair cable	16		16		2
Cable Clasps	more than 12-pair cable	14			3	2
	less than 12-pair cable	14		14		2
Inside Wiring Nails		16		16		2
Staples		7-1/2		7-1/2		1
Bridle Rings			4		8	2 thru 8-1/2*
Drive Rings			4		8	2 thru 8-1/2*
Toggle Bridle Rings			4		8	2 thru 8-1/2*
Insulator Supports			4		8	2 thru 8-1/2*
Clip Support B			4		8	2 thru 8-1/2*

\* When changing direction of wire or cable runs where bridle rings, drive rings, and insulator supports are used, the fasteners should be spaced to hold the wire or cable at approximately a 45-degree angle.

**TABLE G**  
**SIZES OF HOLES FOR STATION WIRE**

Type of Wire		Wire Hole Sizes, Inch							
		Number of Jackets							
		1		2		3		4	
		Not Taped	Taped*	Not Taped	Taped*	Not Taped	Taped*	Not Taped	Taped*
Z Station	Quad	1/4	3/8	1/4	1/2	3/8	3/4	1/2	3/4
Z (Block)	Paired	3/8	3/8	1/2	1/2	3/4	3/4	3/4	3/4
	Triple	3/8	1/2	3/4	3/4	3/4	3/4	3/4	3/4

\* Two layers of friction tape.

**TABLE H**  
**SIZES OF HOLES**  
**FOR STATION CABLE**

No. of Pairs	Cable Hole Sizes, Inch	
	D Inside Wiring Cable	
	Not Taped	Taped*
6	3/8	1/2
11	3/8	3/4
12	3/8	3/4
16	3/8	3/4
21	3/4	3/4
25/26	3/4	3/4
50/51	3/4	7/8
75/76	7/8	1
100/101	1	1-1/8

\* Two layers of friction tape.

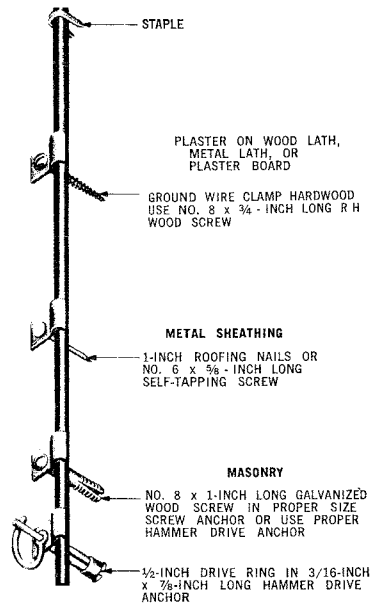
- Space 16 inches apart when wire is subject to displacement.
- Place on every beam when spanning beams.
- Place within 3 inches of wall when run parallel to wall on beams.

**5. FASTENERS FOR GROUND WIRE**

**5.01** Fasteners for ground wire and their use are shown in Fig. 12.

**5.02** Ground wire fasteners should be spaced and placed as follows:

- Space 24 inches apart on ordinary ground wire runs.



**Fig. 12 – Fasteners For Ground Wire**



## Z PROTECTIVE CAP

	CONTENTS	PAGE
1.	<b>GENERAL</b> . . . . .	<b>35</b>
2.	<b>DESCRIPTION</b> . . . . .	<b>35</b>
3.	<b>USE</b> . . . . .	<b>36</b>
4.	<b>CARE</b> . . . . .	<b>36</b>
5.	<b>ARRANGEMENT WITH TELEPHONE HEAD SET</b>	<b>37</b>

### 1. GENERAL

1.01 This section covers the description, use, and care of the Z Protective Cap. This section is reissued to include the requirements listed in CSA Standard Z94.1.

1.02 Safety headgear is designed to act as both a shield and a shock absorber to protect against head injuries. The headgear is also designed to guard against electric shock in case of accidental contact with electrically energized objects.

*Note:* Deliberate contact with Power Circuits must be avoided.

1.03 The use of safety headgear in no way reduces the need for good job planning or the requirements for observing the safety precautions outlined in other sections of the Bell System Practices.

1.04 Each employee shall be responsible for the care of the Z Protective Cap in his possession and for its use under the conditions outlined in this section.

### 2. DESCRIPTION

2.01 The Z Protective Cap is made of moulded poly-carbonate or poly-vinyl which conforms to CSA Standard Z94.1 for both physical

and electrical properties. It is coloured YELLOW for non-management workers, and WHITE for management in accordance with Provincial laws now in effect. Provincial or Federal Safety Inspectors must be readily able to identify the person in charge of a work operation. It bears the company symbol on the front.

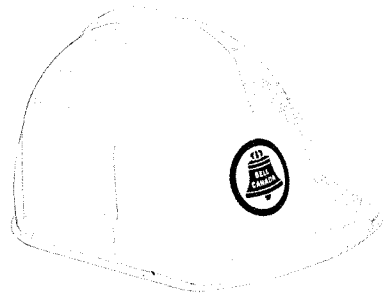


Fig. 1 — Z Protective Cap

2.02 The Z Protective Cap is equipped with either of two removable adjustable suspensions to fit "standard" 6¾ to 7⅞ sizes and "large" to fit 7½ to 7⅞ sizes. Regardless of the adjustment made for head fit, a minimum separation of 1¼ inch between the top of the head and the shell of the cap will be assured.

2.03 Winter Liners are available as accessory items and are available in the following sizes:

SIZE	HEAD SIZE (in 1/8 in. increments)
Small	6-¾ to 7-¾
Large	7-¾ to 7-7/8

2.04 The Liner is to be worn between the shell and the suspension.

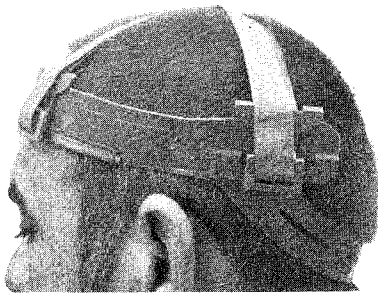


Fig. 2 — Suspension For Z Protective Cap

### 3. USE

**3.01** Safety headgear shall be worn by all craft, services, and management personnel in work situations where they are subjected to conditions which could result in (1) head injuries from falling or moving objects or (2) exposure to striking head on fixed objects or (3) electric shock from accidental contact with electrically energized objects.

**3.02** Following are examples of the more common work operations and conditions under which safety headgear shall be worn:

- (a) Performing all kinds of work, (i.e. line, splicing, installation and repair work) from aerial lifts or truck mounted ladders.
- (b) Performing all work aloft such as from poles and ladders, ladder platform.
- (c) Working with, or in the vicinity of construction apparatus and equipment such as derricks, booms, winches, take-up reels, earth boring machines, cable trailers, tractors, trenchers and cable plows.
- (d) When underneath a work operation being done aloft, or when performing overhead work from the ground such as placing blocks on strand, raising wire, and pruning trees.
- (e) All pole placing and removal work.
- (f) Entering, leaving, and working in man-holes except when not exposed under the opening and headroom is sufficient.

- (g) Working in any area or enclosure, where headroom is limited, such as in crawl spaces, basements and steam tunnels.
- (h) Working in or near trenches, splicing pits, or other excavations.
- (i) When in or near buildings under construction or being demolished.
- (j) When in an industrial establishment or on other premises where the wearing of head protection is mandatory.
- (k) Storm restoration work.
- (l) In the vicinity of blasting operations.

### 4. CARE

**4.01** Protective caps should not be left lying around or stored among other tools where they can be damaged. When not in use, store the cap in a safe place such as in a truck compartment or splicer's cart. Do not place the cap on the rear shelf of an automobile, as sunlight will adversely affect the protection offered by the cap. The cap could also become a missile in case of a sudden stop.

**4.02** Clean the protective cap by washing with soap or detergent and water. To clean, remove the suspension, and dip the shell in warm soapy water. Scrub with a brush if necessary. **DO NOT USE ANY ABRASIVE.** Rinse in clean, warm water and wipe dry. After rinsing, inspect the cap for damage that was not apparent before cleaning. The suspension may be washed with regular soap and water.

**4.03** Because paint will damage plastics, the cap must not be painted. If it is desirable to place some identification on the cap, such as the wearer's name, this identification should be placed on dymo or other pressure-sensitive tape attached to the cap. Do not use any metallic tape.

**4.04** No accessories should be attached to the protective headwear as they may affect the original degree of protection.

**4.05** A large variety of aromatic solvents and chlorinated hydrocarbons will affect the materials in the cap. Some of the aromatics are:

Benzene, kerosene, acetone, creosote, phenol, toluene, alcohol.

Some of the chlorinated hydrocarbons are: dichlorethylene, trychloroethylene, and carbon tetrachloride.

**4.06** Materials containing any or similar ingredients as those listed in para. 4.05 should not be allowed to remain in contact with the cap. For example; Insect Repellant or wax contains alcohol and other material which affect plastics and should not be applied or sprayed on the cap.

**4.07** If the protective cap should be subjected to a severe blow, or is exposed to chemicals or fumes, it should be replaced. Any cap that becomes cracked, punctured, or otherwise damaged (deep scratches or deep grooves) which thereby reduces its effectiveness, must be replaced.

**4.08** The shells and suspension of caps should be checked semi-annually to determine their

condition. To ensure maximum protection for the wearer, it is recommended that shells should be replaced within five (5) years and suspensions, within one (1) year, unless inspection reveals defects prior to the expiration of these periods.

**4.09** The crown lace, if any, should always be tied with a square knot. If the entire suspension is held in the shell by a lace, this lace should also be tied in a square knot.

**4.10** Chin straps and Winter Liners when used with headwear should not be drawn over the brim or peak.

## **5. ARRANGEMENT WITH TELEPHONE HEAD SET**

**5.01** When a protective cap is worn (Part 3) and it is necessary to use a telephone head set, the headband of the head set may be placed under or over the suspension without making any adjustments to the suspension.





## NE714QA TOOL

CONTENTS	PAGE
1. GENERAL . . . . .	39
2. DESCRIPTION . . . . .	39
3. CONNECTIONS . . . . .	40
4. USE IN PARTICULAR CONDITIONS . . . . .	41

### 1. GENERAL

**1.01** This section covers the description and use of the NE714QA Tool which is used to terminate conductors on the 66 Type Connecting Blocks, except those used in E.S.S. C.O.'s.

**1.02** This section is reissued to add Part 4.

**1.03** The NE714QA Tool replaces the 714B which should be returned for replacement. The blade may be rotated to the desired position by loosening holding screw and pulling out blade. When desired position is reached, the blade must be pushed back into handle before tightening screw, otherwise movement of the blade while operating may take place.

### 2. DESCRIPTION

**2.01** The NE714QA Tool consists of a rotary steel blade having two cutting heads and two seating heads, attached to a yellow and green plastic handle.

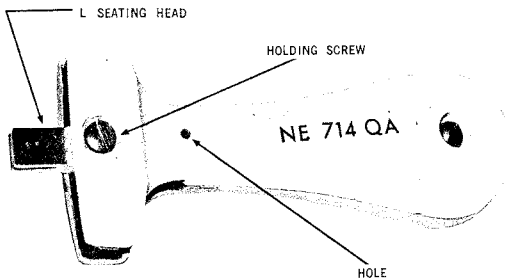


Fig. 1 - NE714QA Tool

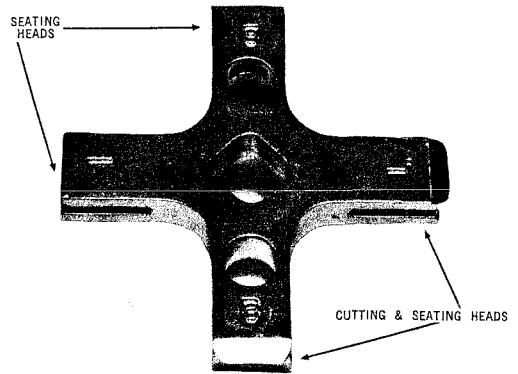


Fig. 2 - Rotary Steel Blade

**2.02** The blade consists of two restricted heads and two non-restricted heads. Restricted heads are identified by the letter "B". Non-restricted heads are identified by the letter "L".

**2.03** Restricted heads ("B") must be used to seat, or to seat and cut conductors on clips that are mounted on white 66 Type Connecting Blocks.

**2.04** Non-restrictive heads ("L") may be used to seat and cut conductors on clip terminals mounted on light green 66 Type Connecting Blocks such as NE66Q6A-25 and NE66Q3B-50 types.

*Note:* It is important that the right type of head (restrictive or non-restrictive) be used on the right type of block, otherwise unnecessary efforts will be required when using Tool and broken connections may result.

**2.05** The handle of the NE714QA Tool is yellow and green. The cutting edges of the blade should be inserted on the yellow side of the NE714QA for ease of identification.

*Note:* Always carry the NE714QA Tool with the cutting edges enclosed in the handle when not in use.

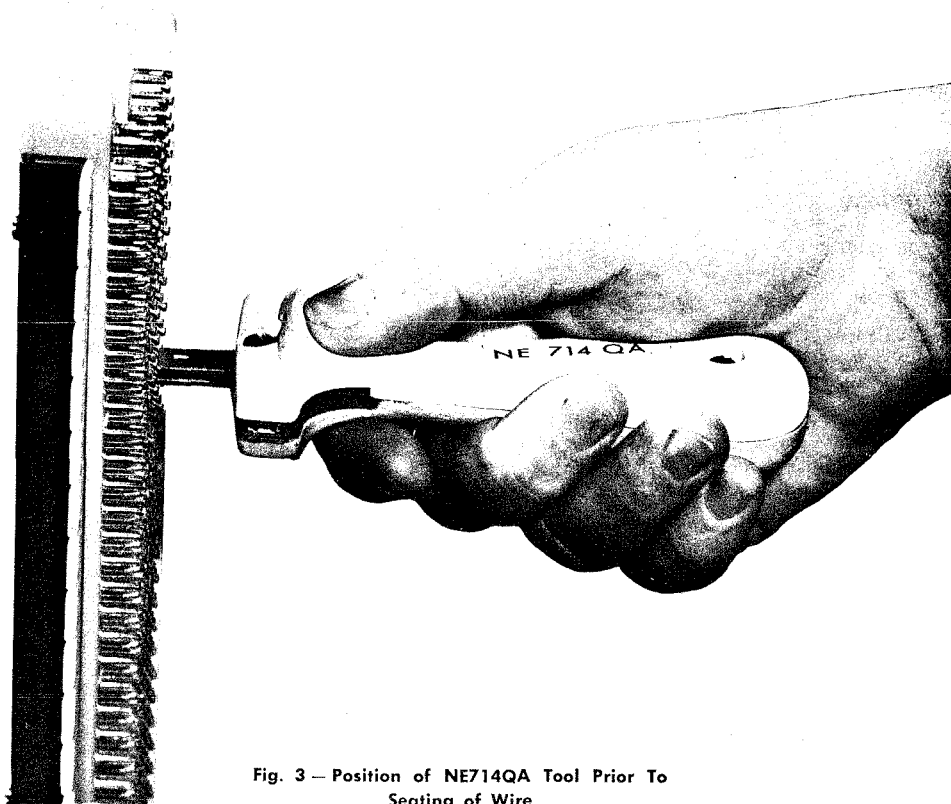


Fig. 3 — Position of NE714QA Tool Prior To Seating of Wire

### 3. CONNECTIONS

3.01 Prepare the conductors as outlined in the appropriate sections.

#### 3.02 Connections — Cutoff Method

- (a) Place the conductor in the hook part of the terminal clip.
- (b) Place the appropriate cutting and seating head of the NE714QA over the terminal clip.
- (c) Keeping the NE714QA Tool in a plane perpendicular to the face of the block,

steadily exert a uniform force and press the tool towards the block until the wire is fully seated and cut off.

#### Notes:

- (1) Do not make a connection by hitting the NE714QA Tool. (i.e. pounding on it in any way) A proper connection can be obtained through a steady application of force.
- (2) When using the non-restrictive head (only on light green 66 Type Connecting Blocks) a positive indication is given that

the connection is made (force to cut conductor insulation, then easy to the base).

(d) To ensure a proper connection, allow the blade to seat and cut the wire before removing cutoff end.

(e) No lubricants shall be present on wire or terminals. Their presence may prevent clips from cutting through insulation of the wire.

### 3.03 Connections — Looping Method

After the wire has been placed in the terminal clip, seat the wire using the appropriate seating head as outlined in Para. 3.02 (c).

## 4. USE IN PARTICULAR CONDITIONS

4.01 On some Connecting Blocks like the 66E3-25, cover latches or other attachments may prevent the blade of the NE714QA Tool from

engaging deep enough to provide a good seat and cut the conductor.

4.02 To alleviate such conditions, the following is a method to extend the Rotary Blade.

(a) Loosen the holding screw (See Fig. 1).

(b) Pull the Rotary Steel Blade forward.

(c) Remove the Amphenol Connector locking screw and insert it in the hole in the NE714QA Tool's handle. (See Fig. 4). This will prevent the blade from pushing back.

(d) Tighten the holding screw.

This will provide sufficient insertion to seat and cut conductors properly.

4.03 On completion of the connections replace the locking screw on the Amphenol Connector. Readjust the Rotary Steel Blade in the normal position.

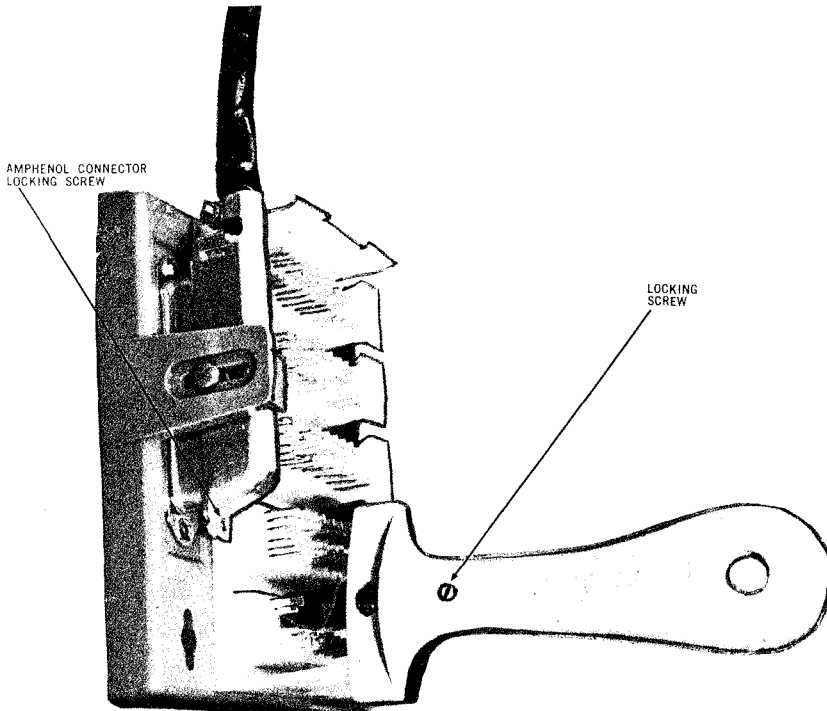


Fig. 4 — 66E3-25 Connecting Block



## INSULATING GLOVES

### DESCRIPTION, CARE, AND MAINTENANCE

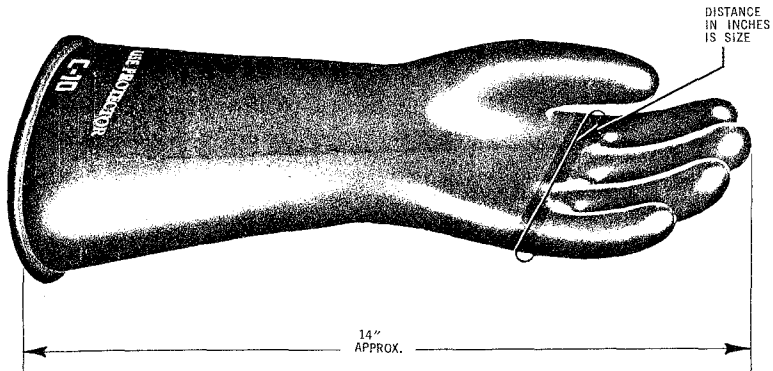
CONTENTS	PAGE
1. GENERAL . . . . .	43
2. TYPES OF INSULATING GLOVES . . . . .	44
3. C LEATHER PROTECTOR GLOVES . . . . .	44
4. B FABRIC LINER GLOVES . . . . .	44
5. INSULATING GLOVE BAGS . . . . .	45
6. ELECTRICAL TEST . . . . .	45
7. TESTS OF INSULATING GLOVES . . . . .	45
8. MAINTENANCE OF INSULATING GLOVES . . . . .	47
9. USE OF INSULATING GLOVES . . . . .	47
10. STORING INSULATING GLOVES . . . . .	48
11. DISPOSITION OF INSULATING GLOVES REQUIRING ELECTRICAL TEST . . . . .	48

#### 1. GENERAL

**1.01** This section covers the description, care, maintenance and general use of insulating gloves, provided for electrical protection of workmen and the safety precautions to be followed in their use. Information on the C Leather Protector Glove, B Fabric Liner Glove, which are associated with C and E Insulating Gloves, and on the Insulating Glove Bag, is also included.

**1.02** This section is reissued to up-date the information and add additional tests. As this is a general revision marginal arrows normally used to indicate changes have been omitted.

**1.03** *The C and E Insulating Gloves are a personal tool, therefore, each employee must at all times assume full responsibility for the condition of his own Insulating Gloves.*



C OR E INSULATING GLOVE

**SECTION 081-710-200CA**  
**SECTION 075-141-501CA**

**2. TYPES OF INSULATING GLOVES**

**2.01** There are two types of Insulating Gloves.

The D Insulating Gloves for Central Office use and the C or E Insulating Gloves for Outside Plant use. The manufacturing, testing and retesting specifications require that all types of gloves be capable of withstanding 10,000 volts.

**2.02** The size of the gloves is measured by the number of inches around the glove measured midway between the thumb and the finger crotches. The length of both types of glove is 14 inches from the tip of the second finger to the cuff. The D glove is furnished in size 10 only. The C or E Glove is furnished in sizes 10, 11 and 12. Fabric Liner Gloves can be worn with both types, especially in Outside Plant to keep the hands warm in winter and to absorb perspiration in summer.

**2.03** The C and E Insulating Glove is made of lightweight rubber to permit maximum flexibility. The E type is constructed with two plies of rubber. The outer ply is black and the inner ply is red. It is a requirement that C Leather Protector Gloves be worn over these gloves to prevent mechanical damage. The words "USE PROTECTOR" are marked on the outside near the edge of the gauntlet on the palm side.

**2.04** The C Insulating Glove is made of all black rubber and is electrically identical to the E Insulating Glove but will gradually be replaced by the latter type.

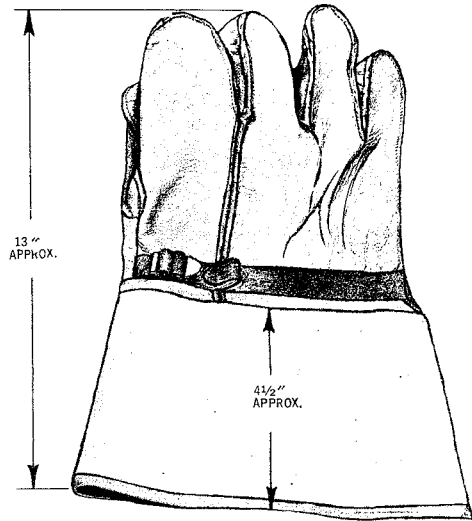
**2.05** The D Insulating Glove is made of rubber of such thickness that protector gloves are not required.

**3. C LEATHER PROTECTOR GLOVES**

**3.01** The C Leather Protector Gloves are used over C or E Gloves to prevent mechanical damage to the rubber. Remember that the leather protector gloves provide no protection from electrical shock. They must not be worn as a substitute for work gloves.

**3.02** C Leather Protector Gloves are made of deer skin, of moccasin style construction

(seams sewn outside at back of the fingers and thumb) and have gauntlet cuffs about 4½ in. wide. They are available in sizes 10, 11 and 12 and should be ordered in the same size as the Insulating Glove.



C LEATHER PROTECTOR GLOVE

**3.03** Leather protector gloves shall be given reasonable care in use. Oil, grease, pentox, creosote, paint, etc., on the palm and finger surfaces of the gloves will impair their usefulness for work operations and could deteriorate the rubber of the Insulating Glove underneath. Foreign matter should be immediately wiped off the gloves with a soft dry cloth.

**3.04** Inspect leather protector gloves before and after using them. Remove all foreign particles imbedded in the surface, especially splinters of wood or metal, which may have damaged the rubber of the Insulating Gloves.

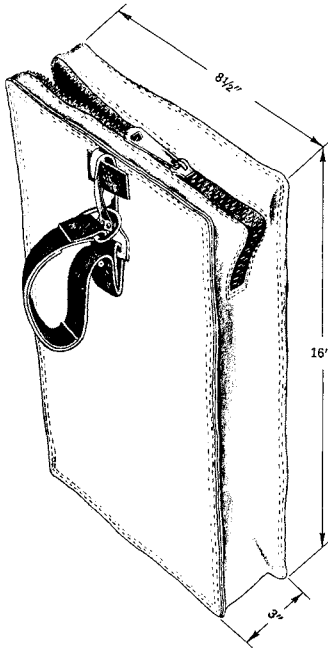
**4. B FABRIC LINER GLOVES**

**4.01** B Fabric Liner Gloves are knitted cloth gloves with an inside woolly surface. These gloves should be worn inside C or E Insulating Gloves for warmth in cold weather and for absorbing perspiration in warm weather.

## 5. INSULATING GLOVE BAGS

5.01 The Insulating Glove Bag is provided for carrying and storing insulating gloves and associated leather protector and fabric liner gloves.

5.02 The Insulating Glove Bag is made of cotton duck with a liner of polyethylene. A zipper is provided for opening and closing the top of the bag. A web strap, terminated in a snap hook and a dee ring is provided for suspending the bag from the body belt and for suspension in the vehicle.



INSULATING GLOVE BAG

5.03 Dead air space is provided within the bag by the polyethylene liner and by the use of a zipper instead of a flap closure. The bag should be tightly zippered when gloves are stored in it. This is essential to minimize deterioration of the rubber of the Insulating Gloves while in storage.

## 6. ELECTRICAL TEST

6.01 Insulating Gloves are inspected and subjected to an electrical test when purchased from the manufacturer to insure that they do not contain any defects which might cause breakdown of the gloves when employees are using them.

6.02 To insure that insulating gloves held in stock and those in use by the field forces are maintained in safe condition **Workmen And Storekeeper Shall See That The Gloves Are Returned For Periodic Inspection And Electrical Test, As Outlined In Part 7.**

## 7. TESTS OF INSULATING GLOVES

7.01 **Each Employee Must At All Times Assume Full Responsibility For Determining That His Insulating Gloves Are In Good Condition. He Shall See That Their Appearance Indicates Neither Deterioration Nor Injury From An Electrical Or A Mechanical Standpoint. He Shall See That They Are Being Used Within The Specified Electrical Test Period As Indicated By The "Return For Test" Date Stamped On The Back Of The Gauntlet.**

7.02 **Each Employee Shall Test His Insulating Gloves.**

- (a) **At The Time He Receives The Gloves**
- (b) **Each Time Before Using Them**
- (c) **Each Time After Using Them**

7.03 A visual inspection of Insulating Gloves shall be made to determine their condition. If any of the following conditions are found to exist or if the condition of the gloves is such that there is any doubt as to their safety, they shall be exchanged at once for a pair in good condition.

- (a) **EXPIRED OF MISSING "Return for Test (Month) (Year)".** Printed on the back of the cuff of each glove. Make sure that the date is not expired. Turn in the gloves one month before the expiry date.
- (b) Squeeze the fingers of the glove together, let go quickly, the glove should return to normal, fingers should not stick together. If there is any sign of stickiness, the gloves must be exchanged at once for a pair in good condition.



**SECTION 081-710-200CA**  
**SECTION 075-141-501CA**

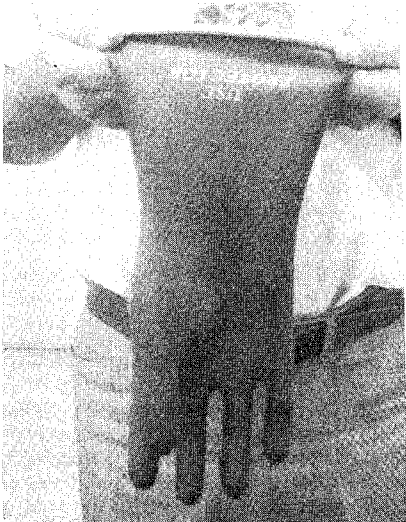
(c) To test the mechanical strength and the deterioration of the gloves, grasp the end of the gauntlet with one hand and pull strongly on each finger of the glove with the other hand. Look for signs of abrasion or deterioration on the sides, palms, and back of the glove. Grasp the thumb and the little finger and pull strongly, looking for cracks between the fingers. Now grasp the index finger and the 4th finger and do the same test. Worn spots will be indicated by undue stretching or by tearing of the glove.

(d) Stretch the glove along both edges, (thumb side and little finger side) while looking for cracks and tears. Do not be afraid of tearing the gloves. This is the purpose of the test.

**7.04** With the E Insulating Gloves, if the appearance of one colour is showing through the other it means that the glove is defective and not safe for use, they shall be exchanged at once for a pair in good condition.

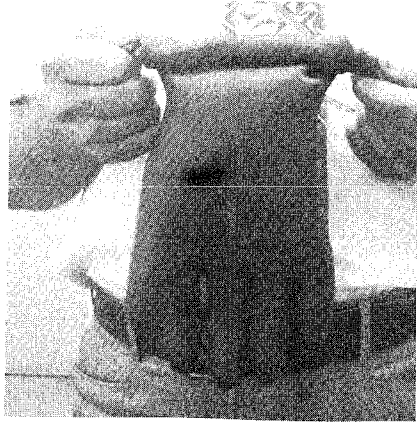
**7.05** The air test shall be made on Insulating Gloves after performing the above tests and just prior to the gloves being used.

(a) Hold the glove at each side of the gauntlet and stretch.



OPERATION 1

(b) Revolve the glove about the edge of the gauntlet as an axis, thus rolling it toward the palm and confining the air in the palm and fingers.



OPERATION 2

(c) Hold the rolled-up gauntlet tightly in one hand.

(d) Squeeze the palm of the glove with the other hand so as to put the confined air under pressure.



OPERATION 3

**7.06** To detect air leaks, hold the back side and then the palm side of the glove close to your face.

**7.07** If any puncture exists, it will be detected by feeling or hearing the escaping air and the hole in the glove may be evident.

**7.08** If a puncture is found or if the condition of the gloves is such that there is *any doubt* as to their safety, they must be exchanged at once for a pair in good condition.

## **8. MAINTENANCE OF INSULATING GLOVES**

**8.01** **In No Circumstance Shall Repairs Be Made To Insulating Gloves In The Field.**

**8.02** Insulating Gloves having obvious defects shall be tagged "Defective" and shall be returned to the Telephone Distributing House for repairs. **The Cuffs Of Insulating Gloves Shall Not Be Cut.**

**8.03** Insulating Gloves should be turned inside out and wiped clean when they become wet from perspiration. The outside surface should be wiped clean when the gloves are subjected to contact with dirt, mud, paint, creosote or other foreign matter.

**8.04** Use clear water to remove perspiration, mud, dirt or other foreign matter which does not adhere firmly to the rubber.

**8.05** Remove paint and creosote as soon as practical, as they may deteriorate the rubber.

**8.06** The following method has been found satisfactory for removing paint and creosote from Insulating Gloves:

- (a) Wipe off the gloves with a dry cloth so as to remove as much wet paint or creosote as practical.
- (b) Wash them with water. If the paint or creosote residue cannot be removed, turn the gloves in for another pair.

**8.07** After Insulating Gloves are used, they should be thoroughly dried so that the moisture from the hands will not become entrapped and cause the glove to deteriorate. Each time after use, gloves should be turned inside out to dry. After the gloves have been dried, they shall be turned right side out and placed in the containers ready for use.

## **9. USE OF INSULATING GLOVES**

**9.01** The C or E Insulating Gloves *must* be worn while performing the following job operations.

- (a) Placing poles in joint use lines.
- (b) Operating derricks or other aerial devices near power lines.
- (c) Stringing or removing strand, wire or cable on joint-use lines, or when crossing under a power line in the portion of the line in which the work is being performed.
- (d) While tending reels when conditions in (c) apply.
- (e) When using the Z Voltage Tester.

**9.02** Telephone employees shall not handle electric power or trolley wires or telephone plant crossed with electric power except in the following emergency situations. **Under The Following Conditions, C or E Insulating Gloves, Fabric Liners and Leather Protective Gloves Must Be Worn.**

- (a) In cases of emergency to prevent injury or loss of life to an employee or to the public.
- (b) After storm damage, when some work on the telephone plant is imperative, before obtaining the assurance that the plant is clear.
- (c) On line troubles, when fuses or protectors have operated indicating the possible existence of an abnormal voltage.
- (d) On line troubles when the tester has cautioned the workman regarding the possible presence of foreign voltage on any part of our plant.

(e) In ascending, descending or working on poles where the employee is exposed to possible contact with electric street lights, power or trolley wires or their associated equipment.

(f) In handling line wires, terminals, protectors or other parts of plant on which foreign voltage is, or is suspected of being present.

(g) Where there is a possibility of wires, suspension strand, cables, or guys which are being placed or removed coming in contact with electric light, power, trolley or other foreign conductors.

#### **10. STORING INSULATING GLOVES**

**10.01** B Fabric Liner Gloves and C Leather Protector Gloves, where required, shall be stored with the C or E Insulating Gloves so that they are available for use. Each of these gloves shall be dry before being stored.

**10.02** Fabric liner gloves and leather protector gloves shall be separated from the Insulating Gloves before being stored.

#### **10.03 Suggested Storing Methods:**

(a) Fold the leather part of the Protective Gloves inside the cuff to prevent creosote, paint, metallic clips or other foreign matter from contacting the Insulating Gloves. Place them in the bottom of the bag and place the B Fabric Liners on top. Stand the Insulating Gloves upright with the fingers to the top for drainage purposes.

*Caution: When closing the bag, make sure that the fingers of the Insulating Gloves will not get pinched by the zipper.*

(b) With forearm outstretched and palm of hand upward, place one Protective Glove palm down on your hand and arm, place one Insulating Glove over the Protective Glove, place both Fabric Liners, place the second Insulating Glove over the liners and then place the second Protective Glove over the others with the palm out. All gloves should have the fingers pointing towards your body. Slide all gloves in the bag holding them together with one hand.

*Caution: When closing the bag, make sure that the fingers of the Insulating Gloves will not get pinched by the zipper.*

**10.04** Insulating Gloves deteriorate even when not in use. This deterioration is caused by ozone in the atmosphere reacting with the glove material to produce fine surface cracks. Do not store Insulating Gloves in unventilated rooms containing ozone-producing apparatus or equipment such as commutator-type electric motors and generators. Never place Insulating Gloves near steam pipes, radiators, or in places where they will be subject to heat, as heat will impair the strength of the glove material. For maximum protection of the gloves, the following methods of storage shall be employed.

(a) In the STOREROOM Insulating Gloves shall be kept in the cardboard containers in which they are supplied. These containers are sealed and should not be opened until the gloves are disbursed to the workmen or until returned for periodic inspection and electrical test.

(b) On MOTOR VEHICLES and in SPLICER'S CARTS, Insulating Gloves and associated leather protector and fabric liner gloves shall be kept in the Insulating Glove Bag tightly zippered and hung up in locations suitable for the purpose so as to avoid contact with edged tools.

**10.05** Insulating Gloves and associated leather protector and fabric liner gloves being carried for intermittent use shall be kept tightly zippered in the Insulating Glove Bag. Insulating Gloves in Insulating Glove Bags may, if desired, be attached to the body belt.

#### **11. DISPOSITION OF INSULATING GLOVES REQUIRING ELECTRICAL TEST**

**11.01** Storekeepers are responsible for Insulating Gloves in the storerooms, and workmen for the Insulating Gloves which they have in the field.

**11.02** The dates when Insulating Gloves shall be returned for periodic inspection and electrical test are stamped up on the backs of the gloves and on the cardboard containers.

**11.03** All Insulating Gloves in the field shall be returned to the Telephone Distributing House not later than the last day of the month specified on the gloves. Wherever possible, return the gloves in their containers to prevent damage.

**11.04** Before returning a pair of Insulating gloves for test, a replacing pair should be secured. The new pair should be ordered not later than the 15th day of the last month stamped on

the pair which is in use to assure arrival before that date.

**11.05** Storekeepers shall see that all Insulating Gloves in their possession are returned to the Telephone Distributing House by the date stamped on the gloves.

**11.06** All Insulating Gloves which are being returned shall be carefully inspected in accordance with Part 7.



**BODY BELTS**

**(LEATHER)**

	CONTENTS	PAGE
1.	<b>GENERAL</b> . . . . .	51
2.	<b>DESCRIPTION</b> . . . . .	51
3.	<b>GENERAL PRECAUTIONS</b> . . . . .	51
4.	<b>SAFETY PRECAUTIONS</b> . . . . .	52
5.	<b>ACCESSORIES</b> . . . . .	52
6.	<b>INSPECTION OF BODY BELTS</b> . . . . .	53
7.	<b>DISPOSITION OF BODY BELTS</b> . . . . .	53

**1. GENERAL**

**1.01** This section describes the Bell System Standard Body Belt. The body belt, together with the safety strap, provides a means of securing a workman to a pole or other structure, thus promoting his safety while working aloft.

**1.02** This section is reissued to update and consolidate information relating to Body Belts into one complete practice. The following practices are replaced by this section and are hereby cancelled.

BSP Number	TITLE
081-720-010	Body Belts - Safety Precautions
081-720-111	D Holsters and B Handline Carrier
081-720-305	Leather Body Belts
081-720-600	Body Belts Inspection

**2. DESCRIPTION**

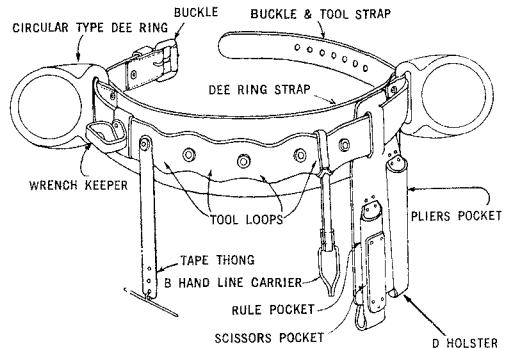
**2.01** Body belts are furnished in 4 inch width and in six sizes, ranging from 18 inches to 28 inches in 2 inch steps. The size of the belt is the distance between "Dee" rings measured in inches.

**2.02** The degree of comfort and satisfactory service which a workman obtains from a body belt depends to a large extent on the location of

the Dee rings with respect to the prominent portions of the hip bones. Most workmen prefer to have the Dee rings located slightly in front of the prominent portions of the hip bones. To obtain a properly fitting belt, measure the distance across the back to the desired locations of the Dee rings and order a belt of this size (to the nearest inch).

**2.03** The punched end of the strap of the body belt has been made sufficiently long to fit the larger workmen.

**2.04** If the buckle strap is too long, it may be shortened by cutting off the excess length provided the cut passes through one of the buckle holes. This will ensure a minimum distance between the last usable hole and the end of the strap, long enough to prevent tearing of the belt by the tongue of the buckle.



**Fig. 1 — Body Belt and Accessories**

**3. GENERAL PRECAUTIONS**

**3.01** Body belts should never be stored with edged tools, or other sharp objects. When body belts, safety straps and climbers are kept in the same container, the climbers should be fitted with gaff guards to prevent damage to the leather by the climber gaffs.

## SECTION 081-720-011CA

**3.02** Never store or place body belts near radiators, stoves, steam pipes, or in place where the leather would be subjected to excessive heat or dampness. Either of these conditions is likely to impair the strength of the leather.

**3.03** When a body belt is damp or wet, wipe it with a dry cloth and allow it to dry completely in a dry shady place. **IT IS ABSOLUTELY PROHIBITED TO PLACE THE BODY BELT NEAR ANY SOURCE OF ARTIFICIAL HEAT** for the following reasons. Investigation has shown that many leather tools dried by artificial heat have been cooked inside. Sometimes the surface shows no defect; in other cases the surface shows only localized hard spots. Yet the inside of the leather has been very seriously damaged by the formation of crystalline material like rosin. This has no strength. The leather fibres are destroyed as it forms. Hard spots on the surface are of the same material. Although the belt may afterward appear to be satisfactory, it is liable to cause injury to the man who cooked it or the man to whom the belt is issued.

**3.04** Do not enlarge the holes for the buckle tongue and do not punch extra holes in the belt.

**3.05** Do not scratch initials, name or other identifying marks on a body belt.

**3.06** Leather body belts may be injured seriously and made unsafe for use if heavy objects such as trucks, trailers, loaded reels, or other heavy equipment, are allowed to run over or fall on the body belt. Care should be exercised to see that this does not occur. If it should occur the belt should be removed from service immediately and given a thorough examination for defects.

### 4. SAFETY PRECAUTIONS

**4.01** The following precautions should be observed when using body belts.

- (a) Wear body belts and safety straps **at all times**, when working aloft on poles, including stepped poles, cable cars, and if a Z Lanyard Belt is not available while working from aerial platforms, ladder platforms, ladders lashed to strand and aerial baskets.

- (b) Do not fasten an uncoiled handline directly to a belt or to tools hanging on a belt when climbing or working on a pole. Either of the following two methods provide a safe means of carrying or supporting an uncoiled handline aloft.

- (1) Form the end of the handline into a loop and place the loop in the handline carrier.
- (2) Form the end of the handline into a bight and tuck the bight up under the body belt.

If the handline should be caught on either an obstruction or a passing vehicle, and the handline is attached by either of the above methods, the handline will be pulled free and the workman will not be pulled off the pole.

- (c) Do not use the body belt to assist in piking poles. In the event that the workman slips or stumbles, the pike pole may slide down between the belt and the body and cause serious injury.

- (d) ***Never place or carry tools or materials, other than the snap hooks of the safety strap, in the Dee rings of the body belt.*** These items should be carried in the standard manner, i.e. using holsters or other approved carriers. ***Foreign materials in Dee rings may prevent proper engagement of the snap hooks in the Dee rings or give false indication of snap hook engagement.***

### 5. ACCESSORIES

**5.01** The D Holster, made of leather, is an off-set double holster with pockets for a rule and pliers, and a pocket for scissors attached to the rule pocket. Only the "Right" D Holster is shown on a "Right" body belt in Fig. 1.

**5.02** The B Handline Carrier is a device which may be attached to a body belt and used for securing one end of a rope while climbing a pole. It is made of a steel loop designed to release the rope under strain. The loop is attached to a rawhide strap approximately 8 inches long and slit near the opposite end. The slit in the strap permits attaching the carrier to the body belt as shown in Fig. 1.

## 6. INSPECTION OF BODY BELT

**6.01** The belt should be examined to determine the condition of all parts as suggested below. If any of the following conditions are found to exist, or if the condition of the belt is such that there is any doubt as to its safety return the belt to the Telephone Distributing House.

**6.02** *Visual Inspection of Body Belts:* The important conditions to look for are:

- (a) Broken steel reinforcement plates holding Dee rings.
- (b) Leather of loop over reinforcing plates worn or crushed by the Dee ring at the edges sufficiently to affect its strength or to cause the leather to tear.
- (c) Loose or broken rivets (particularly those in the loops holding the Dee rings).
- (d) Broken or rotted threads in the stitching of the loops holding the Dee rings.
- (e) Cracks, cuts, etc., that would tend to cause the leather to tear or would be likely to affect the strength of the belt.
- (f) Leather hard and dry.
- (g) Broken wrench keeper.
- (h) Broken or defective buckle.
- (i) Burnt leather (see Paragraph 3.03).

**6.03** Leather with hard spots, a curved set or indistinct portion of the ironed crease along the edge, as well as leather having a burnt streak across the face may have become burned or cooked by being subjected to excessive heat. This may have happened to a belt in any of the following ways:

- (a) Placing the belt against or near hot steam pipes, radiators, or heaters.
- (b) Placing belt near a pot of hot solder, hot soldering copper, or a splicer's furnace.

**6.04** *Visual Inspection of Leather Tool Holster:* The important conditions to look for are:

- (a) Loose or broken rivets.
- (b) Broken or rotted threads in stitching.

**6.05** *Bending Test for Leather:* This test should be made on body belts only when the leather is clean and well oiled. The leather should show no cracks other than slight surface cracks when the test is applied. If well defined cracks appear, the belt must not be used, but should be taken out of service and disposed of in accordance with the Company's established routine. The test should not be made if the temperature of the leather is below 32°F., since at low temperatures the leather may be damaged by bending it around the test mandrel.

(a) Leather shall be bent with the grain (smooth) side out, over a mandrel that is not less than  $\frac{3}{4}$ -inch in diameter (a  $\frac{3}{4}$ -inch guy rod may be used). In making this test, pull the leather taut, and wrap it half-way around the mandrel, keeping the leather under tension while the bend is being made. This procedure brings the leather into firm contact with the mandrel while the bend is being made, and thus avoids bending the leather too sharply. **Do not loop the leather first and then pull it over the mandrel. Do not make the bend test at a buckle hole.**

(b) Body belts shall be subjected to the bend test at points where it is possible to bend them, such as under the leather tool loops and at the tongue strap.

**6.06** If leather of the thickness used in Bell System standard body belts is subjected to an excessively severe test, such as bending it too sharply (without a mandrel or over too small a mandrel) with the grain side out, good leather may crack because of the excessive strain placed on the grain layer.

## 7. DISPOSITION OF BODY BELTS

**7.01** Body Belts which have developed major defects shall be withdrawn from service for repairs or destruction. Employees in the field shall see that such belts in their possession are returned to the Telephone Distributing House tagged or marked "Dangerous", "Do Not Use" and, if practical, the belt shall be marked to show the location of the defect.





FABRIC SAFETY STRAPS

CONTENTS	PAGE
1. GENERAL . . . . .	55
2. C SAFETY STRAP . . . . .	55
3. D SAFETY STRAP . . . . .	56
4. PRECAUTIONS . . . . .	56
5. INSPECTION . . . . .	59
6. CLEANING . . . . .	59
7. STORING . . . . .	60
8. DISPOSITION . . . . .	60

1. GENERAL

1.01 This section covers the care and maintenance of fabric safety straps and the precautions to be observed in their use.

1.02 This section is reissued to include the method of working on cross connecting type terminals and updates information.

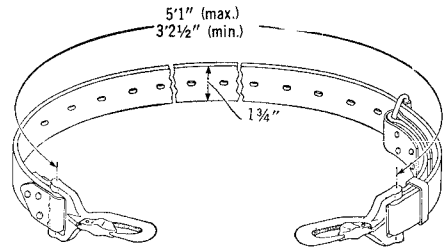
1.03 The C Safety Strap has been superseded by the D Safety Strap. Better quality strap material, round nose snap hooks instead of pointed nose snap hooks, and increased adjustability of the D Strap make it a more desirable strap.

1.04 A relatively small number of C Nylon Safety Straps have oversize holes for the buckle tongue (7/16 in. x 1/4 in. instead of 5/16 in. x 7/32 in.) which necessitates the use of a safety strap keeper (see Paragraphs 2.03 and 2.04).

2. C SAFETY STRAP

2.01 The C Strap is a neoprene impregnated nylon fabric strap vulcanized so as to provide a well-bonded multiple ply construction which has no exposed raw edges. The center plies are of a contrasting color (usually red) from that of the outer plies. Exposure of the center plies by wear indicates that the strap should be removed from service.

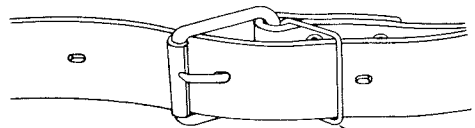
2.02 The C Strap is equipped with pointed drop forged snap hooks and a tongue-type buckle. It has been issued in only one size but it is adjustable in length in increments of 1/2" from 38 1/2" to 61" (see illustration).



C SAFETY STRAP

2.03 C Nylon Safety Straps with oversize holes are equipped with a safety strap keeper (see illustration) to prevent accidental disengagement of the buckle tongue while the strap is in use.

2.04 The wire keeper is attached to the loop holding the buckle so that the keeper encloses the adjustable portion of the safety strap as illustrated.



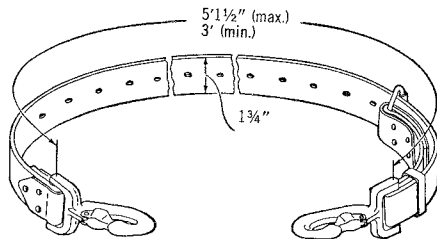
SAFETY STRAP KEEPER

**3. D SAFETY STRAP**

**3.01** The D Strap is the same as the C Strap except for the following:

- (a) Better quality strap material.
- (b) Round nose duckbill snap hook replaces pointed nose snap hook.
- (c) Adjustability of strap increased by the addition of two buckle holes.

**3.02** The D Strap is available in one size only. It is adjustable in length in increments of  $1\frac{1}{2}$ " from  $36$ " to  $61\frac{1}{2}$ " (see illustration).



D SAFETY STRAP

**4. PRECAUTIONS**

**4.01** A fabric safety strap may be injured seriously and rendered unsafe for use if heavy objects such as trucks, trailers, reels, pole derrick members, or other heavy equipment are allowed to run over or fall on the strap. Care should be exercised to see that this does not occur. If it should occur, the strap should be removed from service immediately and given a thorough examination for defects. The important defects to look for are:

- (a) Broken, cut, or torn outer fibers and
- (b) Broken inner fibers. Defects are usually found in the section at which the injury occurred. Breakage of the inner fibers is indicated by limpness and flexibility of the strap. The strap should be examined in short sections and if a soft, flexible section is found, the strap should not be used.

**4.02** All C Nylon Safety Straps having buckle holes measuring  $7/16$  in. long should be equipped at all times with a wire keeper. Any such straps not so equipped should be removed from service until the required keeper has been installed. It is intended that these straps should be returned to the Telephone Distributing House in exchange for straps equipped with the wire keeper. The use of the keeper does not apply to other safety straps.

**4.03** If at any time, the wire keeper on a C Safety Strap becomes defective or is lost the strap should be returned to the Telephone Distributing House.

**4.04** Before climbing a pole, adjust the length of the safety strap and see that the tongue of the buckle is properly seated in the desired hole in the strap.

- (a) A body belt and safety strap shall be worn at all times when working on poles (including stepped poles).

- (b) A body belt and safety strap or "Z" Lanyard Belt shall be worn at all times while working in an aerial lift truck basket. The snap-hook shall be attached to the Dee ring provided in the baskets for this purpose.

- (c) The "Z" Lanyard Belt may be used in place of the body belt and safety strap for the following operations; aerial or ladder platform and fastened ladders. (For use and care of the "Z" Lanyard Belt see Section 081-721-900).

**4.05** Place strap around pole so that the strap rests flat against the pole surface. The strap should not have turns or twists.

**4.06** A workman may improve his security by placing the strap around the pole at a point directly above a cross arm, strand, pole step, or other secure attachment which is to remain in place while he is on the pole. Do not place a strap around an insulator pin, a bolt, or other insecure attachment. Do not place a strap around a pole

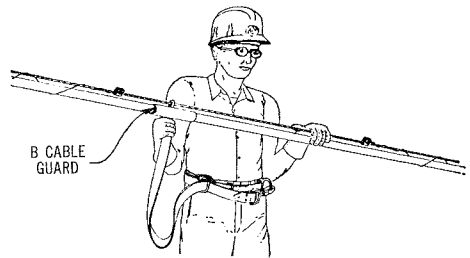
within one foot of the top of the pole unless there is a crossarm or cable attachment on the pole above the strap.

- (a) Electric light, power and foreign signal circuit attachments shall never be used as supports for the safety strap.

**4.07** *Never attach two or more safety straps together for additional length.* If one safety strap can not be lengthened sufficiently to reach around a large tree or other object, the method of doing the work shall be changed. If tree pruning operations are involved, only a rope sling shall be used.

**4.08** A man working on an aerial platform or an extension ladder that is securely supported by a suspension strand or other support may use one of the following methods to secure himself with his body belt and safety strap. Attach one snap hook to a Dee ring, and either:

- (a) pass the free end of the safety strap between two rungs and around one side rail, and engage the snap hook in *the other* Dee ring or,
- (b) pass the free end of the safety strap between the side rails of the ladder and completely around the strand and one rung of the ladder and engage the snap hook in *the other* Dee ring or,
- (c) pass the free end across the front of the body, through the other Dee ring, and engage the snap hook on the suspension strand. When using this method the safety strap should be adjusted to be as short as practical to limit the length of fall if an accident occurs.



**4.09** When working on cross connecting boxes equipped with terminal seats, the following precautions shall be followed:

- (a) Pass the free end of the safety strap across the front of the body and through the other Dee ring and engage free end of strap to Dee ring. (See Fig. 1).
- (b) When using this method the safety strap should be adjusted to be as short as practical to limit fall if an accident occurs.
- (c) When you have climbed the pole and you are ready to move to the terminal seat, get a good grip on the pole or pole step; unsnap the free end of your safety strap from the Dee ring and snap it to the handle of the cross connecting box or the Z Pole Belt Ring. **Then** leave the pole and get up on the seat. (See Fig. 2).
- (d) When coming down, get on the pole and make sure you have a good grip on it, **then** unsnap the strap from the handle, on the Z Pole Belt Ring.



Fig. 1

4.10 Where either the snap hook or buckle of the safety strap is likely to contact the cable sheath, provision should be made to protect the sheath from damage. This protection may be provided by slipping a B Cable Guard over the cable or by wrapping the cable with muslin at the place of contact.

4.11 **SEE THAT THE SNAP HOOK AND DEE RING ARE PROPERLY ENGAGED. DO NOT RELY ON FEEL OR ON THE CLICK OF THE KEEPER** in the snap hook when attaching a safety strap as an indication that the fastening is secure. The workman shall **LOOK** and **KNOW** that the snap hook is properly engaged before placing his weight on the strap. Always have keeper of snap hook on safety strap away from the body when engaged in the Dee ring, as shown in the following illustration.

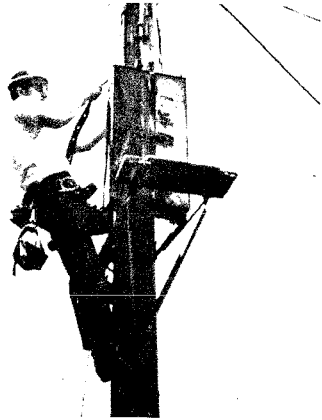
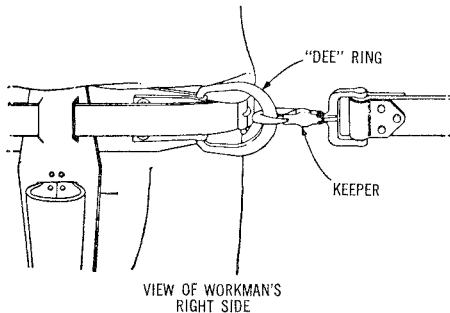


Fig. 2

4.12 The following are additional precautions:

(a) *Exercise care when working aloft so that the keeper of the snap hook is not depressed accidentally by contact with wires, strand, crossarm braces, guys, and other attachments, or by crossarms, guard arms, cable cars, etc., that may be supported on the safety strap in the course of performing certain work operations.*

(b) A safety strap should never be used as a means of riding suspension strand.

(c) Never use an improvised substitute of rope, wire, etc., for a safety strap.

(d) Do not punch extra holes in a safety strap.

(e) While wearing a safety strap which is not in use, both ends of the safety strap should be snapped into the same Dee ring. Care should be exercised to see that the safety strap does not catch on pole steps, and other attachments when climbing poles.

(f) When climbing past another workman who has his safety strap in place around the pole, exercise care to avoid dragging the climber gaffs over his strap and cutting it.

- (g) Avoid swinging rapidly around a pole in a safety strap.
- (h) Do not throw or drop a safety strap.
- (i) Exercise care to prevent damage to a safety strap from heat by contact with, or placing it near, a furnace, pot of hot solder, torch, or hot soldering copper.
- (j) Do not stand near a fire while wearing a safety strap or body belt.

## 5. INSPECTION

**5.01** Each employee, when receiving a safety strap, and at least once a week thereafter, should inspect the strap in accordance with Paragraph 5.05 so that he may detect any fault that may have developed.

**5.02** Each employee should at all times assume the responsibility for determining that his safety strap is in good condition.

**5.03** The supervisor should inspect each safety strap periodically.

**5.04** The safety strap should be examined visually to determine its condition. If any of the conditions in Paragraph 5.05 are found to exist or if the condition of the strap is such that there is any doubt as to its safety, it should be exchanged at once for one in good condition, in accordance with the Company's established routine. A fabric safety strap should never be subjected to proof load tests.

**5.05** *Visual Inspection of Safety Strap:* The important conditions to look for are:

- (a) Worn fabric, as indicated by the colored ply. When two outer layers of fabric are worn through, the colored ply can be seen. The strap should be removed from service as soon as a colored ply becomes visible.

- (b) Cuts, nicks, punctures, etc., that would affect the strength of the strap. The edges of the strap should be inspected carefully.

- (c) Loose, broken, or missing rivets, or rivets with excessive wear.

- (d) Broken or badly worn steel guard on ends of safety strap.

- (e) Defective buckle, or defective snap hook, and poor action of the keeper on the snap hook. The keeper should work freely without excessive side play, and should close securely under the spring tension.

- (f) Charred spots on the surface of the fabric, such as might have been caused by flames, contacts with hot solder pots, furnaces, hot soldering coppers, heated ducts and pipes. If burns are on the flat surfaces, remove strap from service if two or more outer layers are burned through, or if the colored ply is visible. If these burns are on the edges of the strap and are more than  $\frac{1}{8}$  inch deep remove strap from service.

- (g) Acid burns. A strap that has been in contact with acid shall be removed from service.

- (h) Holes for tongue of buckle excessively enlarged.

## 6. CLEANING

**6.01** Employees in the field shall clean Fabric Safety Straps in accordance with instructions contained herein. Safety straps requiring repairs shall be returned to the Telephone Distributing House.

**6.02** Remove any creosote, paint, oil, grease, tar, etc., that may collect on the strap by wiping the strap with a clean, dry cloth. If this does not remove the surface deposit, petroleum spirits of NEKS 5372 stabilized Trichloroethylene should be used on a clean, dry cloth to remove surface deposits. Do not soak the strap, but rub vigorously with the moistened cloth. This cleaning shall be done in a well ventilated location.

## SECTION 081-721-200CA

**6.03** If the strap becomes heavily caked with dried creosote paint or tar apply creosote remover to the surface of the strap to soften the deposit. Daub the paste heavily on the caked spots and allow to remain for, from 15 minutes to one hour, the longer time being required to soften the heavier deposits. The strap should then be wiped with a cloth moistened with trichloroethylene or petroleum spirits. Repeat the operation, if necessary, to remove the deposit.

**6.04** No oiling or dressing is required.

**6.05** Treat inner side of Fabric Safety Strap with an application of Crayon Soapstone.

**6.06** Dispose of discarded cloths containing Trichloroethylene or Petroleum spirits by burning in small quantities, preferably in the open.

### 7. STORING

**7.01** The following precautions should be observed when storing the safety strap or when it is not in use:

(a) Keep strap away from radiators, stoves, steam pipes, fires, and other places where the fabric would be subjected to excessive heat.

(b) A damp or wet strap should not be packed in lockers, tool boxes, tool cases, grips, or other containers. The strap should be wiped with a dry cloth and allowed to dry completely by ventilation before storing or packing.

(c) The safety strap should never be stored with tools unless such tools are equipped with satisfactory guards. When body belts, safety straps and climbers are kept in the same container, the climbers should be fitted with gaff guards to avoid cutting or puncturing the strap with the climber gaffs.

(d) Store strap in a location free from excessive humidity to prevent mildew.

### 8. DISPOSITION

**8.01** A strap with major defects shall be withdrawn from service immediately and returned to the Telephone Distributing House. Such straps shall be tagged "Dangerous, Do Not Use," and if practical, the strap shall be marked to show the location of any defects that cannot be readily seen. Where it is an established practice, employees remote from the storeroom shall destroy and dispose of junk straps on the job if instructed to do so by the supervisor.

## C BODY BELTS INSPECTION AND MAINTENANCE

CONTENTS	PAGE	
<b>1. INSPECTION ROUTINE</b> .....	<b>61</b>	
<b>2. INSPECTION OF C BODY BELT</b> .....	<b>61</b>	
<b>3. CLEANING C BODY BELT</b> .....	<b>61</b>	
<b>4. DISPOSITION OF C BODY BELTS                  REQUIRING REPAIRS</b> .....	<b>61</b>	
<b>1. INSPECTION ROUTINE</b>		
<b>1.01</b> Each employee on receiving a C Body Belt and at least once a week thereafter should inspect his belt in accordance with Part 2 to detect any faults which might have developed.		
<b>1.02</b> Each employee should assume the responsibility for determining that his C Body Belt is in good condition.		
<b>1.03</b> The supervisor shall inspect C Body Belt periodically.		
<b>1.04</b> This section is reissued to cancel existing exchange schedules.		
<b>2. INSPECTION OF C BODY BELT</b>		
<b>2.01</b> The C Body Belt should be examined to determine the condition of all parts as suggested in Para. 2.02. If any of the following conditions are found to exist or if the condition of the belt is such that there is any doubt as to its safety, it should be exchanged at once for one in good condition, in accordance with local routine.		
		<b>2.02 Visual Inspection:</b> The important things to look for are:
		(a) The condition of the steel reinforcing plates holding the Dee rings.
		(b) The condition of the nylon, especially at the reinforcing plates, to determine whether the nylon is worn or crushed sufficiently to affect its strength.
		(c) Loose or broken rivets (particularly those in the loops holding the Dee rings).
		(d) Broken or rotted threads in the stitching.
		(e) Cuts that would tend to cause the nylon to tear or affect its strength.
		(f) Broken or defective buckle.
<b>3. CLEANING C BODY BELT</b>		
		<b>3.01</b> Tests indicate that creosote is not injurious to nylon. However, because the creosote may stain the workman's clothing, it should be removed from the C Body Belt as soon as practicable using a cloth moistened with Petroleum Spirits.
<b>4. DISPOSITION OF C BODY BELTS REQUIRING REPAIRS</b>		
		<b>4.01</b> A C Body Belt which has developed a major defect shall be withdrawn from service for repair or junking. Employees in the field shall see that such a belt is returned to the storeroom tagged or marked "Dangerous Do Not Use" and if practicable, the belt shall be marked to show the location of the defect. If a Division has established the practice, an employee remote from the storeroom shall upon instruction from his supervisor, destroy and dispose of a defective belt.





### CLIMBERS

CONTENTS	PAGE
1. GENERAL . . . . .	63
2. DESCRIPTION . . . . .	63
CLIMBERS . . . . .	63
SLEEVES . . . . .	64
PADS . . . . .	65
STRAPS . . . . .	65
GAFF GUARDS . . . . .	66
3. PRECAUTIONS . . . . .	66
4. FITTING AND ASSEMBLING CLIMBERS . . . . .	67
5. INSPECTION OF CLIMBERS . . . . .	68
6. TESTING CLIMBER GAFFS . . . . .	69
7. FIELD MAINTENANCE . . . . .	70
8. RETURNING CLIMBERS FOR MACHINE SHARPENING . . . . .	72
9. EXCHANGE SCHEDULES . . . . .	72

#### 1. GENERAL

- 1.01 This section describes the climbers and associated items such as pads, straps and gaff guards.
- 1.02 This section is reissued to delete "C" climbers.
- 1.03 The method of testing the effectiveness of climber gaffs is included. The pole cutout test replaces both the plane test and the board cutout test. This method is more critical of the proper shape and sharpness of the gaff. It also simulates actual climbing conditions and is more convenient since it can be made just prior to climbing a pole.

#### 2. DESCRIPTION CLIMBERS

- 2.01 Adjustable climbers have replaced fixed length climbers. The E Climber, Fig. 1, which supersedes the D climber is changed to use two set screws instead of one set screw and a rivet for attaching the sleeve to the leg iron.

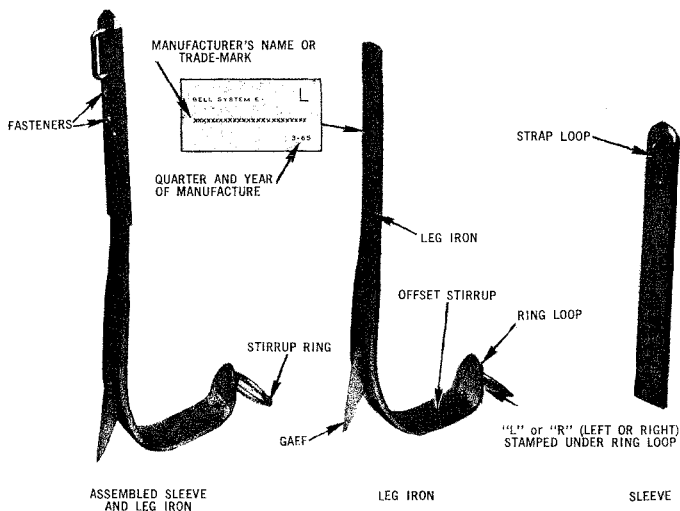


Fig. 1 - E Climber

This will allow the craftsman to remove the sleeves, pads and straps for reuse when returning climbers to be sharpened. As D Climbers are returned for sharpening, the rivet holes in the leg irons will be tapped so that two set screws can be used to attach the sleeves. A fully machine

shaped and sharpened gaff is used on the E Climber. No filing is required at time of manufacture or when resharpened. The gaff has been designed so that it can be machine sharpened without any filing to reshape the outer rounded surfaces shown in Figs. 10 and 11. **Do not use a file on these surfaces at any time.** This will disturb the design of the gaff so that it cannot be machine sharpened satisfactorily. Climbers may be ordered with or without sleeves. Sleeves including Fasteners or Fasteners only can be ordered separately. Pads and straps must be ordered separately. Gaff guards may also be ordered separately, however, all new and resharpened climbers are packaged with gaff guards installed.

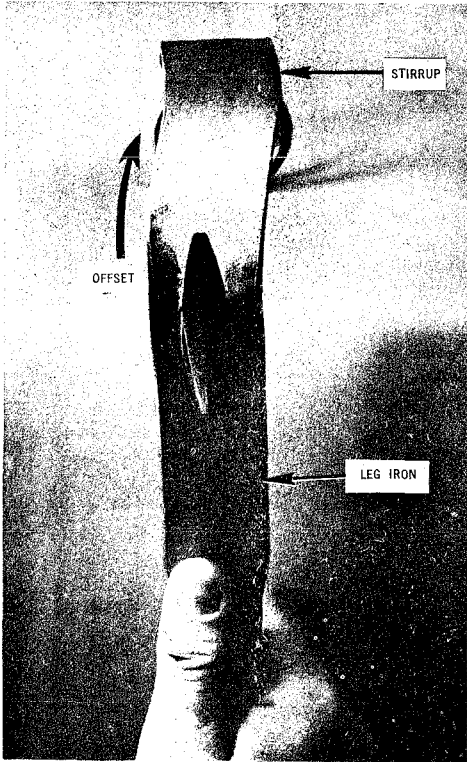


Fig. 2 – Stirrup Offset "Right"

**2.02** Adjustable climbers have offset stirrups, therefore, they are made for the right and left foot and are marked "R" or "L" on the appropriate climber as indicated in Fig. 1. These climbers can be identified as right or left by remembering that the offset of the stirrup is toward the front of foot. Another method is to hold the climber with gaff toward you and pointing up, then noting which direction the stirrup is offset. If the offset is to right, it is a right climber as in Fig. 2; if the offset is to left, it is a left climber.

**SLEEVES**

**2.03** Sleeves used with adjustable climbers can be adjusted in increments of 1/4 inch. They are available in two lengths. Fig. 3 illustrates these sleeves and the range of adjustments. Sleeves are attached to climbers by two set screws known as Fasteners except on the shorter sleeves from 14 3/4 to 15 1/2 inches and on the longer sleeves from 17 3/4 to 18 1/2 inches. On these adjustments, only one set screw is used for attachment. For these lengths, the wedging of the sleeve and leg iron provides a sufficiently tight fit of these parts.

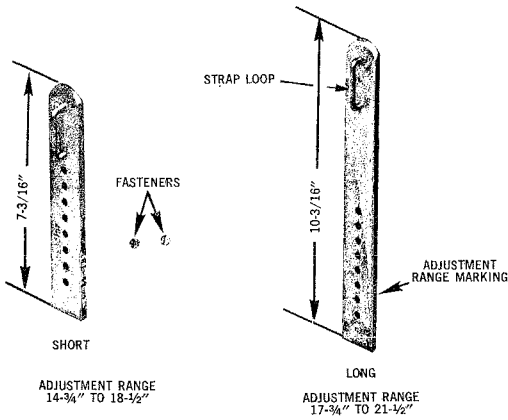


Fig. 3 — Sleeves for Adjustable Climbers

**PADS**

2.04 Angle climber pads, Fig. 4, are available for use with climbers.

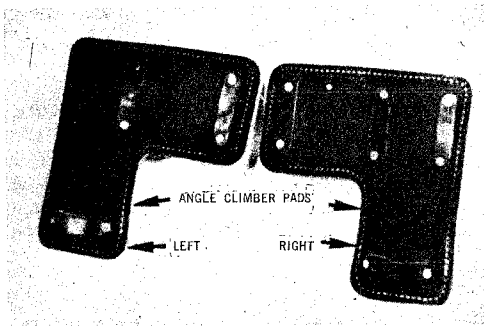


Fig. 4 — Pads

**STRAPS**

2.05 C Climber Foot Straps, Fig. 5, are used on the stirrup rings of adjustable climbers to fasten the climber to the foot. A C Climber Foot Strap consisting of a tongue and buckle that can be clipped to the climber stirrup ring is placed on the climber so that the buckle will be across the foot instep when fastened. The metal clips on the Buckle and Tongue straps are manufactured 1/32" oversize to permit attachment to the stirrup ring. After the clips have been properly engaged in the ring they must be closed tightly, by the user, with a 1 1/2 lb. drilling hammer or 9" sidecutting pliers to prevent them from becoming unsnapped.

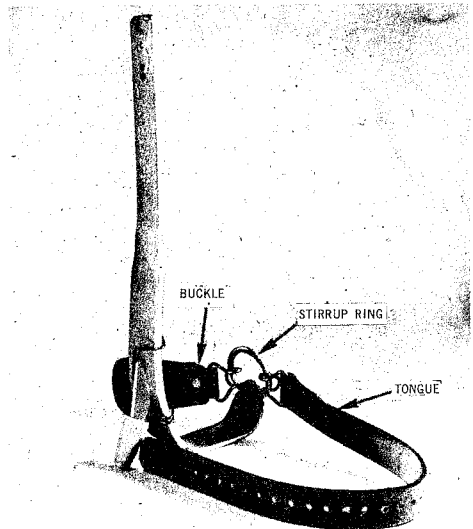


Fig. 5 — C Climber Foot Strap Installed on Right Climber

## SECTION 081-730-101CA

2.06 The 22-inch B Climber Strap, Fig. 6, is used to hold the pad on the leg iron and to fasten both to a craftsman's leg when the climber is worn.

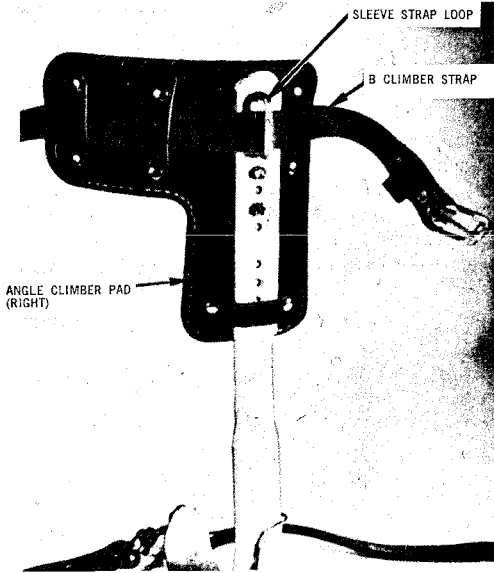


Fig. 6 — Angle Climber Pad (Right) Installed

### GAFF GUARDS

2.07 Gaff guards are used to protect gaffs and workmen when climbers are not being used. They also protect other tools from damage that are stored in vicinity of climbers. Fig. 7 illustrates a gaff guard installed.

### 3. PRECAUTIONS

3.01 Observe the following precautions when storing, transporting, and using climbers:

- (a) Equip climbers with gaff guards, when not in use. Gaff guards protect craftsmen as well as the gaff tips and cutting edges when climbers are carried by craftsmen or are stored in tool boxes or other storage spaces. They also prevent damage to safety straps and body belts when stored in the same compartments with climbers.
- (b) Use climbers adjusted to correct size, Part 4.

- (c) Do not bend leg irons. If discomfort exists, use angle climber pads.

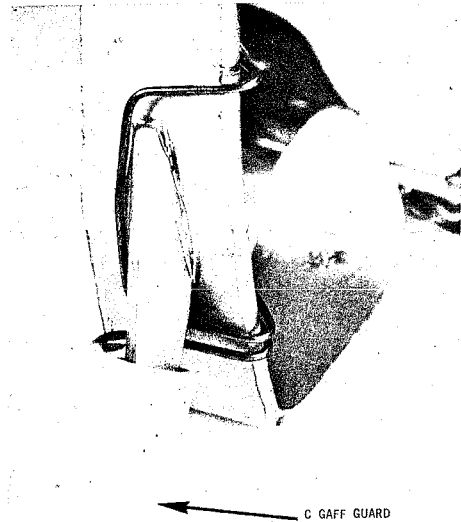


Fig. 7 — C Gaff Guard Installed

(d) NEVER WEAR CLIMBERS ON WORK WHERE THEY ARE NOT REQUIRED as, for example, when working on ground, a ladder, a stepped pole where the work can be performed safely from the steps, or while travelling in a motor vehicle or any other type of conveyance.

(e) When climbing past another employee who has his safety strap in place around the pole, special care should be taken to avoid gaffing the other employee, his safety strap or other equipment.

(f) When climbing past attachments on poles, care should be taken to avoid dragging climbers or foot against these attachments.

(g) Do not use the gaff as a pry.

(h) When climbing, avoid placing the gaff in or near a crack, knot, nail, or tack, etc.

(i) Inspect climbers in accordance with Part 5.

#### 4. FITTING AND ASSEMBLING CLIMBERS

4.01 Determine the correct sleeve to use by measuring the distance from the lower edge of the projecting kneebone to the underside of the shoe at the arch, Fig. 8, and subtract 1/2 inch. Select the sleeve (see Para. 2.03), that covers this range. When ready to assemble the climber for use, first place the C Foot Straps as indicated in Para. 2.05.



Fig. 8 — Measuring for Climber Length

Next, place a B Climber Strap and pad on sleeve as shown in Fig. 6. Place the strap so the tongue will point toward back of leg when buckled. Place sleeve on climber, step on stirrup and adjust sleeve to position that is most comfortable. Place one of the set screws to hold the sleeve in place and put climber on to see if it feels comfortable; if so remove climber and add second set screw to hold sleeve in place (see Para. 2.03). The same procedure can be used for the other climber. Climbers should be adjusted to the maximum length which is comfortable. Fig. 9 illustrates assembled climber strapped to leg.

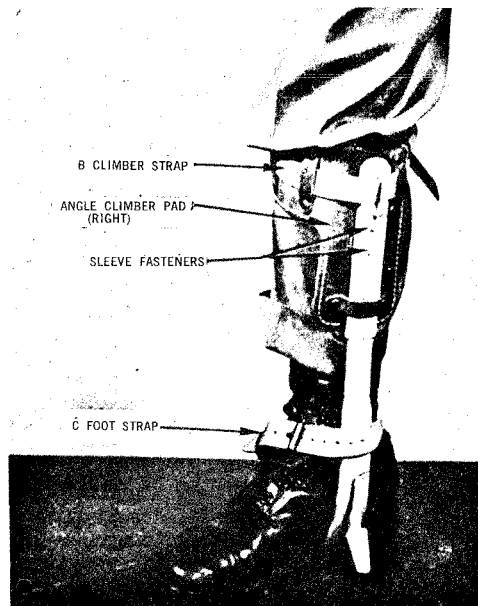


Fig. 9 — Right Climber on Leg

## 5. INSPECTION OF CLIMBERS

**5.01** Each employee shall assume the responsibility for determining that his climbers, sleeves, pads, straps and gaff guards are in good condition and shall inspect the gaffs to detect nicks or dulled cutting edges daily, or more often, if he has any reason to think they are not in good condition such as after accidentally hitting a nail or tack while climbing a pole. If there is any question that the gaffs are in good condition, check them with the pole cutout test, see Part 6. Furthermore, upon receipt of the climbers and at least once a week thereafter, he shall inspect the climbers and associated items in accordance with Para. 5.03 to detect any flaw that may have developed. In addition, climbers shall pass the pole cutout test.

**5.02** The employee's supervisor shall make an inspection of the climbers at intervals of not more than three months.

**5.03** The important conditions to look for when inspecting climbers are as follows:

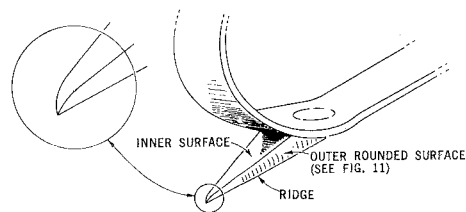
- (a) Evidence of Filing or reshaping which shall not be done.
- (b) Fractured gaff or hairline crack.
- (c) Loose Gaffs.
- (d) Broken stirrup ring or broken or loose ring loop.
- (e) Fractured leg iron or start of fracture.
- (f) Nicks and depression in gaff due to impact with a hard object.
- (g) Ridge of gaff not straight.
- (h) Dull gaff beyond restoration by means of honing.
- (i) Broken or distorted gaff point.
- (j) Fractured sleeve or start of fracture.
- (k) Broken or loose sleeve strap loop.
- (l) Straps worn through one layer of fabric or with cuts or enlarged buckle holes that would affect the strength.
- (m) Broken or otherwise defective strap buckle.
- (n) Broken or otherwise defective clip on foot strap.

- (o) Broken or loose rivets on straps or pads.
- (p) Broken or torn loop on strap or pad.
- (q) Plastic missing from gaff guard.
- (r) Loose screw on sleeve.

**5.04** If any of the conditions, Para. 5.03 (a) to (i) inclusive, are found, or if the condition of the climbers is such that there is good cause to doubt their safety, they shall not be used but shall be exchanged for a pair in good condition. If any of the conditions (j) to (q) inclusive are found, the item shall be replaced. If condition (r) is found, the screw shall be tightened or replaced.

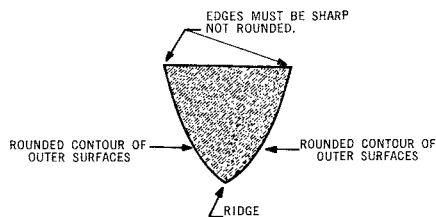
**5.05** The following illustrate the surfaces and ridge of a properly-shaped gaff. The ridge is straight.

- (a) Profile of gaff at point.



**Fig. 10—Gaff Profile and Point**

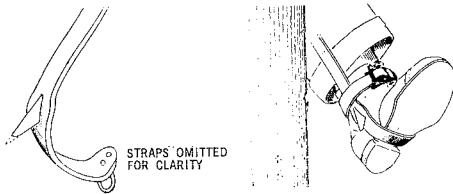
- (b) Rounded contour of outer surfaces and sharp cutting edges.



**Fig. 11—Outer Surfaces**

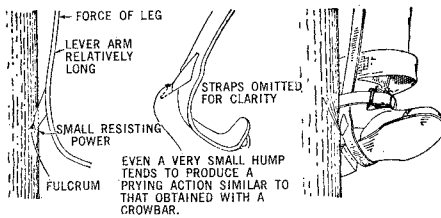
**5.06** The following illustrations show two principal causes of climber cutouts due to unsatisfactory gaff conditions.

- (a) Insufficient penetration resulting from a dull gaff.



**Fig. 12 – Dull Gaff**

- (b) Ineffective penetration due to ridge not being straight.



**Fig. 13 – Ridge Not Straight**

## 6. TESTING CLIMBER GAFFS

**6.01** Climber gaffs shall be tested when received and thereafter anytime there is any doubt as to their sharpness but at least once a week. They shall be tested by making the pole cutout test as follows:

1. Place the climber on the leg and fasten the foot strap in the usual manner. Do not fasten the leg strap.
2. Remove the gaff guard and put on your gloves. Place your hand between your leg and the climber pad, palm facing the pole. Place the other hand around the pole to

balance yourself. With your leg at about a 30 degree angle, the normal climbing angle, aim the gaff toward the center of the pole about one foot above the ground line. Lightly jab the gaff in the pole, so that it penetrates the wood about 1/4 inch, see Fig. 14. Do this at a location where the pole surface is free of cuts.



**Fig. 14 – Jabbing Gaff in Pole**



3. Keeping just enough pressure on the stirrup to keep the gaff in the pole, but not so much as to cause the gaff to penetrate any deeper; push the climber and your hand toward the pole by moving your knee until the strap loop of sleeve is against the pole as shown in Fig. 15.



Fig. 15 – Climber Holding

4. Making certain the strap loop is held against the pole with pressure from your leg, *gradually* exert full pressure straight

down on the stirrup without raising your other foot off the ground, so as to maintain balance if the gaff does not hold.

5. A gaff, which is correctly shaped and is sharp, will cut into the pole and hold in a distance of 2 inches or less. Measure the cut from point the gaff enters the pole to bottom of cut at surface of pole as indicated in Fig. 16.

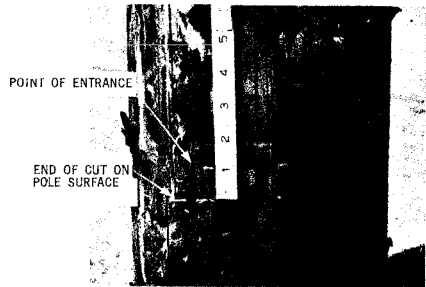


Fig. 16 – Measuring Gaff Cut

A gaff that is correctly shaped but dull or burred will cut in and hold but the length of the cut will be more than 2 inches. A gaff, which is very dull or deformed in some way, will cut out of the pole or plow through the wood for a distance greater than 2 inches. ***Do not use climbers that cut out or plow through the wood for a distance greater than 2 inches.*** If the climber gaff is dull, sharpen with a hone, as described in Part 7 and repeat cutout test.

## 7. FIELD MAINTENANCE

### CLIMBER GAFFS

**7.01** During normal use of climbers the edges along the inner surface (cutting edges), Fig. 17, may become dull. The honing stone should be used to maintain sharp edges. Remember that even a dull gaff can cut your finger, so hone carefully.

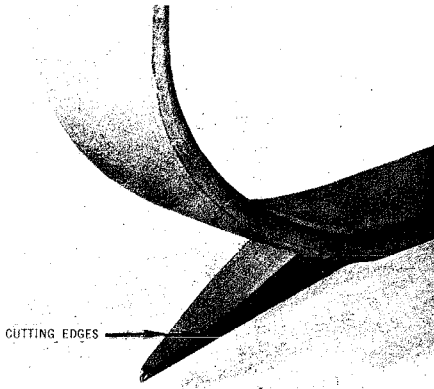


Fig. 17—Gaff Cutting Edges

7.02 In honing, use a standard honing stone. Keep the stone well oiled with light machine oil while honing to prevent clogging the stone.

7.03 First, if there are any small burrs along the cutting edges, remove them by holding the hone against the side of the gaff and *carefully following the edge around to the tip* as indicated in Figs. 18 and 19. **DO NOT FILE OR MAKE THE EDGES ROUND WHILE HONING. THE CUTTING EDGES MUST BE SHARP TO CUT THROUGH THE WOOD FIBRES. ROUNDED EDGES WILL NOT CUT THE FIBRES AND MAY CAUSE CUT OUTS.**

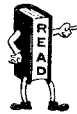


Fig. 18—Removing Burrs from Top Cutting Edge



Fig. 19—Removing Burrs from Bottom Cutting Edge

7.04hone the inner surface of the gaff by starting the stroke near the leg iron and continue over rounded curve of tip as indicated in Fig. 20 Stop the honing stroke before the stone slides off the end of the gaff to prevent dulling the tip. About 20 to 25 strokes of the honing stone should be enough.



**DO NOT ATTEMPT TO RESHAPE THE TIP OF THE GAFF. HONING IS INTENDED TO RECONDITION THE EDGES BUT NOT TO RESHAPE THEM.**

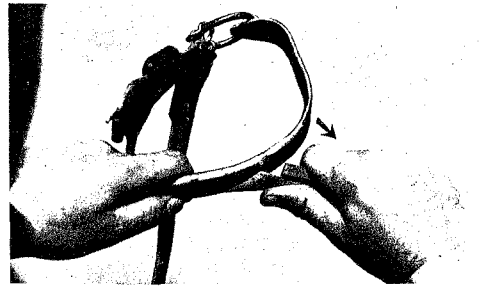


Fig. 20—Honing Inner Surface

7.05 When using a vise to hold a climber, always protect the leg iron by placing wood blocks between the vise jaws and the leg irons as indicated in Fig. 21. This prevents scoring the leg iron which may weaken it.



Fig. 21 — Honing Using Vise

#### PADS

7.06 Pads should be maintained clean and pliable for maximum comfort. Maintain this condition by using saddle soap or neatsfoot oil about every three months as follows:

- (a) Clean with a damp sponge using a neutral hand soap.
- (b) With sponge and clean water, work up a lather using a good grade of saddle soap. Work lather well into pad and put in shade to dry. When lather is almost dry, rub the leather vigorously with a soft cloth.
- (c) About every six months instead of dressing with saddle soap as in (b), clean as in (a), then while leather is still damp apply about 1/2 teaspoon of neatsfoot oil on the loop side of the pad, apply oil gradually with hands using long light strokes to work into leather.

After oiling, allow pads to dry overnight then rub vigorously with a soft cloth to remove excess oil.

#### 8. RETURNING CLIMBERS FOR MACHINE SHARPENING

8.01 When climber gaffs need sharpening and the required sharpness cannot be obtained as described in Part 7, the craftsman shall exchange the leg irons for a pair in good condition. The straps and pads, also the *sleeves unless they are riveted, shall be removed and retained for re-use on the exchange leg irons*. The leg irons to be returned shall be equipped with gaff guards and taped or otherwise tied together. (Fig. 22 illustrates a gaff that has been machine sharpened a number of times, to the minimum length that shall be used).

#### 9. EXCHANGE SCHEDULES

9.01 Return climbers to the Telephone Distributing House when they require resharpening or reconditioning.

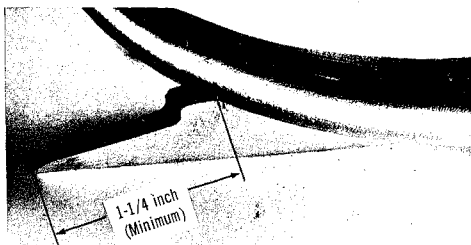


Fig. 22 — Gaff Sharpened to Minimum Length

## EXTENSION LADDERS AND ATTACHMENTS

### DESCRIPTION AND USE

CONTENTS	PAGE
1. GENERAL . . . . .	73
2. DESCRIPTION OF STANDARD EXTENSION LADDER . . . . .	73
3. SAFETY PRECAUTIONS . . . . .	74
4. SELECTING LENGTH OF LADDER . . . . .	75
5. SELECTING FOOTING . . . . .	76
6. PROVISIONS FOR SUPPORTING UPPER END . . . . .	77
7. RAISING AND LOWERING . . . . .	84
8. HANDLING TOP SECTIONS . . . . .	89
9. TRANSPORTING . . . . .	91
10. INSPECTION OF EXTENSION LADDERS . . . . .	95
11. DEFECTS TO LOOK FOR ON LADDER RAILS . . . . .	95
12. DEFECTS TO LOOK FOR ON LADDER RUNGS . . . . .	96
13. DEFECTS TO LOOK FOR ON LADDER FITTINGS . . . . .	96
14. FIELD REPAIRS . . . . .	98
15. STORAGE OF LADDERS . . . . .	99
16. DISPOSITION OF DEFECTIVE LADDERS . . . . .	99

#### 1. GENERAL

1.01 This section describes the standard Extension Ladder and standard attachments presently used in Bell Canada and specifies methods of using the ladders and attachments safely.

1.02 This section is being issued to up-date the information and incorporate the Addendum Issue A which is hereby cancelled.



Fig. 1 — Extension Ladders

#### 2. DESCRIPTION OF STANDARD EXTENSION LADDER

2.01 The *Extension Ladder* is provided for use when working aloft in installation, construction, and maintenance work. The specification requirements under which ladders are supplied to Bell Canada conform to or exceed those of the Canadian Standards Association standard for Portable Ladders. The ladder consists of two wooden sections of equal length, each having parallel side rails and equally spaced rungs. The top section is raised by a  $\frac{3}{8}$  inch manila rope. The top section of each ladder is equipped with two automatic spring locks, securely attached to the side rails, which engage rungs of the bottom section. Stops are provided on older models and 40 foot ladders to prevent over-extending of the upper section.

## SECTION 081-740-105CA

**2.02** Extension Ladders (Fig. 1) are supplied in 24, 28, 32 and 40 foot sizes. The size of an Extension Ladder is the sum of the lengths of the two sections. All ladders are provided with spurs, unless otherwise specified, to prevent the ladder feet from slipping. 24 and 28 foot ladders are equipped with a Pole Grip unless ordered with Rotatable Ladder Hooks for aerial cable work.

### 3. SAFETY PRECAUTIONS

**3.01** Whenever possible in areas exposed to vehicular traffic, place ladder on the strand from the field side to avoid danger from passing vehicles.

**3.02** If a ladder must be placed at a work location where it may be struck by vehicles or pedestrians display warning flags or signs in the most advantageous locations.

**3.03** Ensure that the ladder is in good working condition as defined in Part 10 of this section.

**3.04** *Extension ladders are not to be left erected overnight at work location, as this creates a safety hazard to the public and especially to children. It is also contrary to the Canada Labour Code (Safety of Employees).*

**3.05** Before climbing, ensure that the rungs and side rails of the ladder, also the hands and feet are free from any slippery substances.

**3.06** Do not place ladders on boxes, barrels, or other objects to obtain additional height; use a ladder of sufficient length for the job at hand.

**3.07** Follow the instructions given in Para. 5.03 when the surface on which the base of the ladder is resting is such that the ladder may have a tendency to slip.

**3.08** Do not place a ladder inside or opposite an angle formed by wires or cables where loosening of the wire or cable attachments might cause the ladder to move or fall.

**3.09** Keep hands and feet off the rungs when raising or lowering the top section of an extension ladder. Stand clear when the top section is being lowered so that it will not strike the feet.

Extreme caution must be exercised when lowering the upper section of a ladder equipped with the New Type Spring Lock (See Fig. 35). *Always Lower The Upper Section Slowly.*

**3.10** Make certain that ladder locks are engaged properly and the ladder rope is tied securely to one of the rungs of the bottom section before climbing an extension ladder.

**3.11** If the ladder is equipped with ladder hooks and the ladder is to be used on aerial cable, turn the hooks to the working position before the ladder is raised. Ladder hooks should be placed on the cable strand unless ladder is to be lashed as covered in Para. 6.05. Do not turn the hooks in before descending the ladder.

**3.12** Place ladders not equipped with ladder hooks against the strand so that at least *two rungs extend above the strand* when the craftsman is in position on the ladder.

**3.13** Be especially careful when going up or down ladders during wet or icy weather.

**3.14** *Do not climb a ladder while wearing climbers.*

**3.15** Do not hurry when going up or down a ladder. Take one step at a time. Always face the ladder when going up or down and be sure to have both hands free. *Do not slide down an extension ladder.*

**3.16** Only one person at a time is permitted on a ladder.

**3.17** When a ladder is lashed, secured or otherwise made stable so that it cannot fall, the craftsman may improve his security by passing one leg between the rungs.

**3.18** If the top end of the ladder is secured to suspension strand or other support, (See Fig. 6 and 7) the craftsman may increase his safety by passing his safety strap around one

rung, or between two rungs and around one side rail.

**3.19** When the ladder is properly placed on strand, (hooks over strand or two rungs above strand) pass the safety strap around the strand and one side rail between two rungs.

**3.20** *The craftsman should always remember, to first make himself secure on the ladder by passing his safety strap around one rung and the strand, or between two rungs, around the pole, and one side rail, so that he will not fall if he slips, loses his balance, or if something else goes wrong.* Secure the ladder with a rope as shown in Figs. 6 and 7. The manner in which the craftsman secures himself to the ladder will depend on the nature of the work to be done.

**3.21** Do not throw tools or materials to a craftsman working on a ladder; raise them by means of a handline. Be careful that tools or materials being used aloft cannot fall on persons passing below.

**3.22** Do not attempt to lean to the side so far that the breast bone is beyond the side rail when working on a ladder. Loss of footing in this position may cause loss of balance. The weight being shifted to one side of the ladder may cause it to twist and then slip at the top. Descend and move the ladder to the proper location.

**3.23** When working from ladders do not allow drop wires, lashing wires, handlines, or ladder ropes to dangle to the ground where they may be struck by passing vehicles. A wire or rope caught on a passing vehicle may pull the ladder causing it to fall or it may pull the craftsman off the ladder. The handline, when not in use, shall be tied to the lower portion of the ladder or pulled aloft.

**3.24** Safety boots reaching above the ankle (6" or higher) should be worn when climbing a ladder.

**3.25** Never carry an extension ladder from one location to another while it is extended. First lower the ladder and secure the ladder rope, then extend it again at the new location.

**3.26** Point the spurs forward and downward, about 18" from the ground when carrying a ladder on the shoulder.

**3.27** Avoid swinging the ladder into the path of passing vehicles or pedestrians when carrying a ladder or removing it from a vehicle.

**3.28** Do not place ladders where they may come in contact with power lines.

**3.29** Do not tie drop wires or pulling lines to ladders.

**3.30** Do not use a ladder in a horizontal position as a platform, runway, or scaffold.

**3.31** Do not place a ladder against a suspension strand which is held under tension by a strand puller only.

**3.32** Avoid placing a ladder in front of a doorway, especially where the door opens toward the ladder. Avoid placing a ladder near passageways, near moving machinery, or at locations where vehicles or pedestrians may strike or displace it. When these conditions cannot be avoided, or when a door cannot be secured in the open position or locked with no possibility of its being opened inadvertently, make arrangements to have the ladder guarded by another craftsman. Also, use warning devices to alert people of activity beyond a closed door.

#### 4. SELECTING LENGTH OF LADDER

**4.01** The maximum working length of an Extension Ladder is from 3 to 4 feet less than its given size. The maximum working length for the various sizes of ladder is given in Table A.

<b>SIZE OF LADDER (FEET)</b>	<b>MAXIMUM WORKING LENGTH (FEET)</b>	<b>MINIMUM OVERLAP (FEET)</b>
20	17	3
24	21	3
28	25	3
32	29	3
36	32	4
40	36	4
The 20 and 36 ft. extension ladders are from returns only.		

## SECTION 081-740-105CA

4.02 Local conditions determine the size of ladder to be carried by plant forces. However, the 24 foot extension ladder will usually meet the conditions encountered by installation and repair forces and the 28-foot ladder will meet the requirements of the construction forces. The use of ladder hooks on 24 foot ladders will usually enable the service forces to perform their work along suspension strand without the need for carrying longer ladders. A ladder not equipped with ladder hooks may be used if two rungs extend beyond the strand when a man is standing on the ladder and it is secured to the strand as outlined in Paras. 6.01 through 6.07.

4.03 Always select a ladder of sufficient length for the work to be done. The length of the ladder should be such that the work can be performed when standing no higher *than on the fourth rung from the top*, thus permitting the side rails to be grasped conveniently. If the ladder is too short for the work at hand, obtain a longer ladder.

## 5. SELECTING FOOTING

5.01 Use care in positioning ladders before climbing them. Place the foot of the ladder on the ground or other firm support so that distance B (Fig. 2 and 3) from the base of the ladder to a line extended vertically from the top support is approximately one-fourth of the length of the ladder measured from top support to bottom support. If distance B is greatly exceeded, there is a danger of imposing excessive stresses on the ladder. If distance B is considerably less than one-fourth of distance A, the ladder will be pitched so steeply that the work cannot be done safely. In any case if the base of the ladder is likely to slip, the ladder shall be braced, fastened, or securely held.

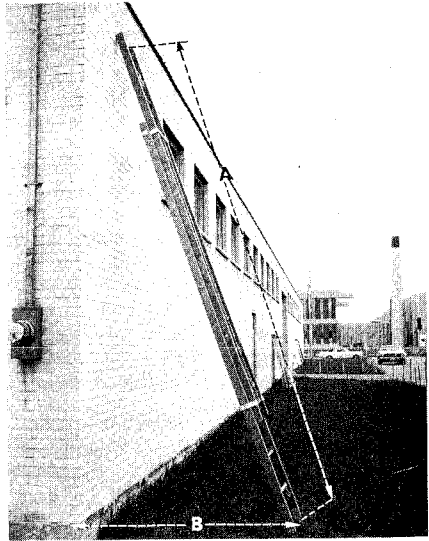


Fig. 2 — Ladder Placed Against Wall

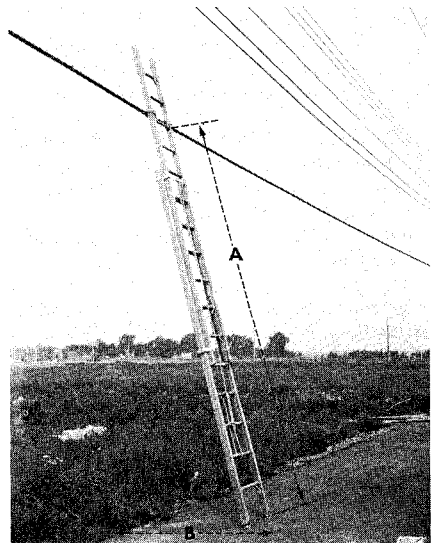


Fig. 3 — Ladder Placed Against Strand

A method of verifying the correct angle of the ladder is called the Firemen's Method, Standing at the foot of the raised ladder, with the toes touching the spurs, extend the arms horizontally. The palms of the hand should be touching the outside of the side rails. If the palm of the hands are beyond the side rails, the pitch of the ladder is too steep. If the palms are not reaching the side rails the ladder is not steep enough. (See Fig. 4).

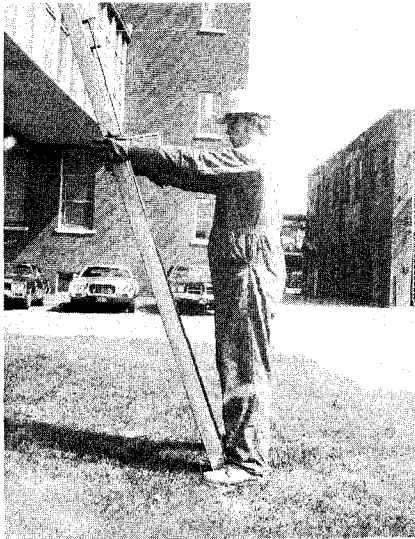


Fig. 4 — Checking Pitch of Ladder

**5.02** Set a ladder only on secure footing. Set both feet of the ladder at the same level and on a line parallel to the surface on which the top of the ladder rests. If necessary, employ a ladder wedge or remove earth from beneath the high side to bring it to the level of the lower side. *Never increase the length of a side rail by nailing a board to it.* If a ladder leans to either the right or the left, it is not properly placed. Always place an extension ladder with the top section to the front. A well placed ladder is shown in Fig. 5.

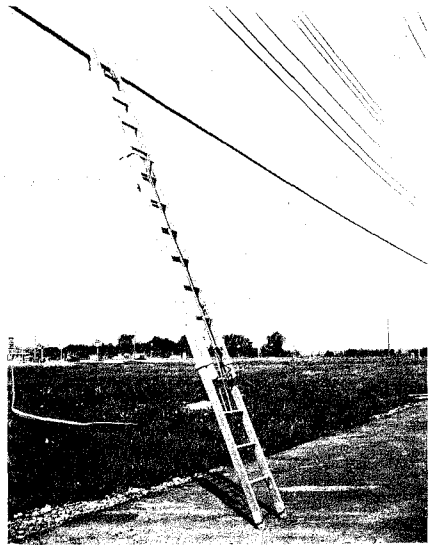


Fig. 5 — Base of Ladder Properly Positioned

**5.03** When it is impossible to avoid placing the base of the ladder on surfaces where it might slip, such as on wet or oily pavements, smooth floors, or metal surfaces, the base of the ladder shall be tied securely in place. If this is impractical, the ladder shall be held by another craftsman. The person holding the ladder shall be on the alert at all times to protect the man on the ladder and anyone passing below him. Never leave a raised ladder unattended under these conditions. The ladder might slip and cause injury, damage or both.

## 6. PROVISIONS FOR SUPPORTING UPPER END

**6.01** Objects against which the top of the ladder will be placed shall be sufficiently rigid and have ample strength to support the ladder and the craftsman on it. Certain work operations performed from a ladder (for example, moving a cable manually) will increase the load on the ladder and this shall be taken into account when judging the strength of the upper support for the ladder.



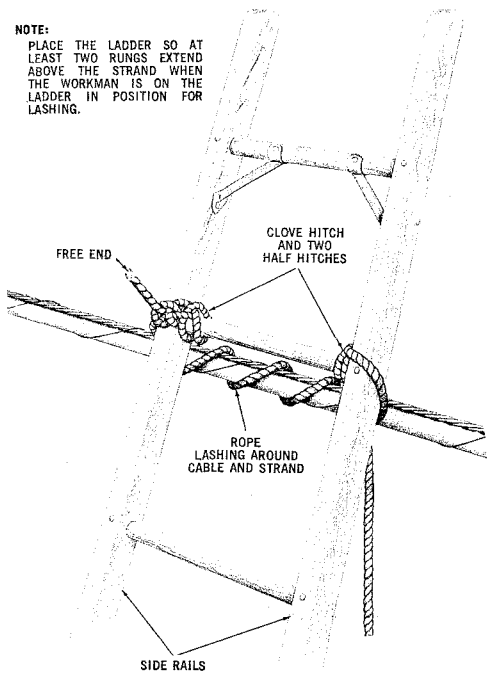
SECTION 081-740-105CA

**6.02** Before placing a ladder against suspension strand, test the strength of the suspension strand and its supports as given in Section 627-295-500.

**6.03** The strand and supports which will withstand the test in 627-295-500 without showing any signs of failure or slippage will have ample strength to support the ladder and craftsman. After such a test, it may be advantageous to leave the rope on the strand for raising and lowering the ladder, and for securing the ladder to the strand as outlined in Paras. 7.01 through 7.17.

**6.04** When using a ladder on a strand having a fairly steep slope, secure the ladder with rope to prevent the top of the ladder from sliding along the strand. Before raising the ladder, throw or place a handline over the strand and secure one end of the handline to the second rung from the top of the top section of the ladder. An easy method of raising a ladder using a handline is covered in Part 7. After placing the ladder on the strand, pull the other end of the handline taut and secure it to an adequate support on the uphill side of ladder, such as a pole, tree, or digging bar firmly placed in the ground. If no such anchorage can be obtained, the ladder may be secured to the cable and strand by throwing or placing the handline over the strand again, so that the rope passes twice around the cable and strand, and then tying the rope securely to a rung on the lower section of the ladder.

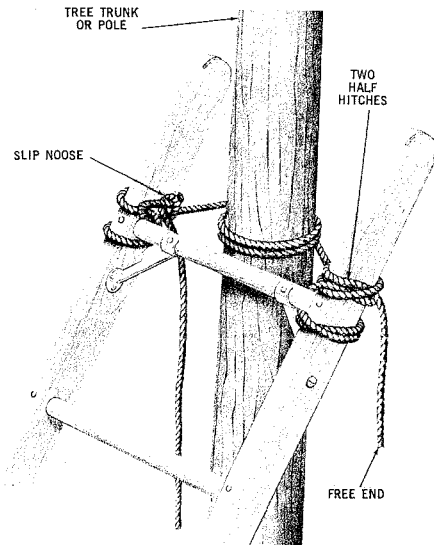
**6.05** When a ladder is placed against the strand and heavy work such as pulling or lifting is to be done, lash the ladder to the strand with a short length of rope, as shown in Fig. 6. Where the cable is supported in rings, pass the lashing rope around the strand only; where the cable is lashed, pass the lashing rope around the strand and cable. *Do not move the base of the ladder after the upper end has been secured to the strand. The ladder MUST NOT be used to support the weight of the strand, cable platform and workman.*



**Fig. 6 — Lashing Ladder to Strand**

**6.06** Take care when pushing or pulling heavy loads from a working position on a ladder not to place undue stress on the ladder.

**6.07** When using a ladder on a suspension strand that is attached to a building wall, wherever possible place the ladder so that it will tend to push the wall attachment against rather than away from the building wall.



**Fig. 7 — Ladder Lashed to Tree or Pole**

**6.08** When placing a ladder against a tree, select the tree trunk or its larger limbs for support. When it is necessary to place a ladder so the top rung rests against a tree trunk or similar object, a handline may be thrown or placed with a wire-raising tool or tree pruner handle over a tree limb, tied to the top rung of the ladder, and used to assist in raising the ladder. After the ladder has been placed, tie the free end of the handline to one of the lower rungs, thus holding the ladder until a more secure lashing is made. The ladder shall be lashed securely at one or two points in a manner which will prevent the ladder from twisting or sliding when the craftsman's weight is put on one side. The lashing can be made in the following manner with a second rope (Fig. 7).

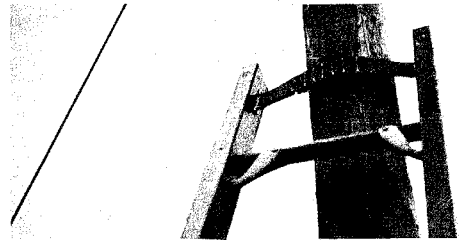
- (a) Make a slip noose about 15 feet from the free end of the rope so that the noose will tighten when the free end of the rope is pulled.
- (b) Place the slip noose over the top end of one side rail.

(c) Pass the free end of the rope down behind and under the top rung, then toward the front of the ladder, around the rail, and then back of the tree or pole.

(d) Make two complete wraps around the tree or pole, then pass the rope twice around the opposite rail below the first rung and then up behind the rung.

(e) Reverse the direction of wrapping and make two half-hitches on the rail so that the ladder is lashed tightly to the tree or pole.

**6.09** All ladders, unless ordered equipped with Rotatable Ladder Hooks are provided with a Pole Grip. The Pole Grip consists of a rubber cleat stitched to a nylon strap and attached between the two side rails near the top of the ladder. The Pole Grip will provide more stability when the ladder is placed against a pole, a tree, or the corner of a building (see Fig. 8).



**Fig. 8 — Pole Grip**

Ladders with or without Pole Grips may have the top lashed to the pole and the lower part tied to the base of the pole without having to climb the ladder. The following method is more effective if the ladder is equipped with a Pole Grip.

- (a) Before raising the ladder tie one end of a handline to the top rung with two half hitches and pass the handline over the Pole Grip to the back of the ladder.

(b) Raise the ladder to the proper height and position. The handline will be hanging to the back of the ladder (see Fig. 9).

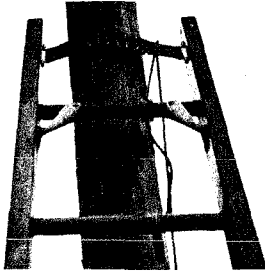


Fig. 9 — Handline in Back of Ladder

(d) Flip the handline over the end of the opposite side rail (see Fig. 11).

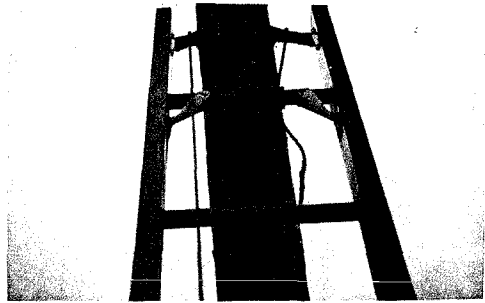


Fig. 11 — Top Lashed to Pole

(c) Bring the handline around the back of the pole (see Fig. 10).

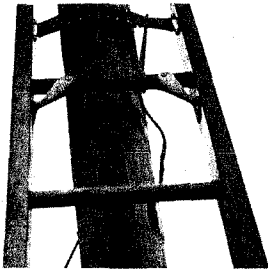


Fig. 10 — Handline Around Pole

(e) Pass the loose end of the handline between two lower rungs and tie snugly to the base of the pole as shown in Fig. 12.

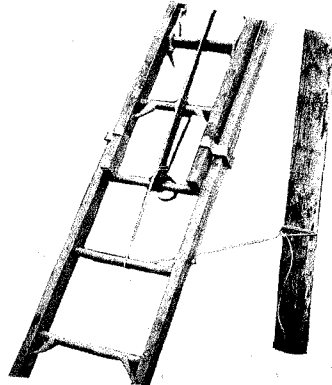


Fig. 12 — Bottom Lashed to Pole

6.10 Never place an extension ladder against a window sash. If it is impracticable to avoid placing a ladder in front of a window, lash a board to the ladder as shown in Fig. 13 in order to provide support on each side of the window frame.

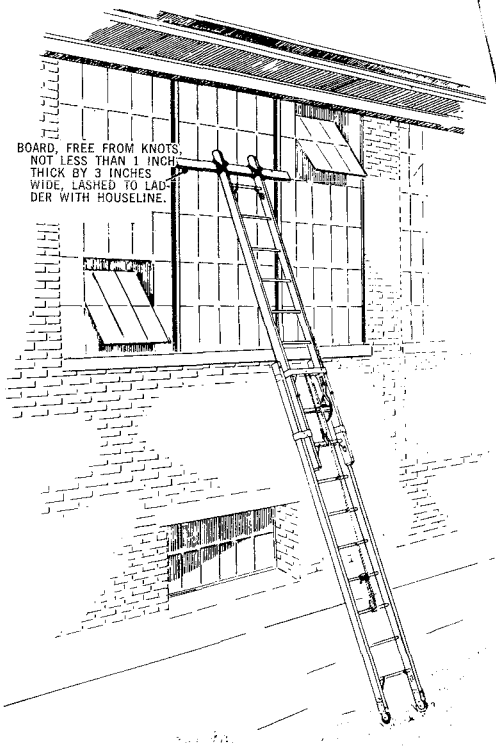


Fig. 13 — Ladder Placed in Front of Window

- 6.11 The *ladder hooks* provided on Extension Ladders are shown in Fig. 14.
- 6.12 When not in use, turn the hooks in between the rails. To rotate a hook, push it toward the lower end of the ladder, turn it 90 degrees, then release. The coil spring locks the hook in either of two positions. Turn ladder hooks in between the rails when the ladder is to be placed against building walls or other flat surfaces.
- 6.13 The ladder hooks should be used on lashed, and ring-supported cables when the ladder

is not lashed to the strand. The use of ladder hooks permits working with a shorter ladder than might otherwise be required.

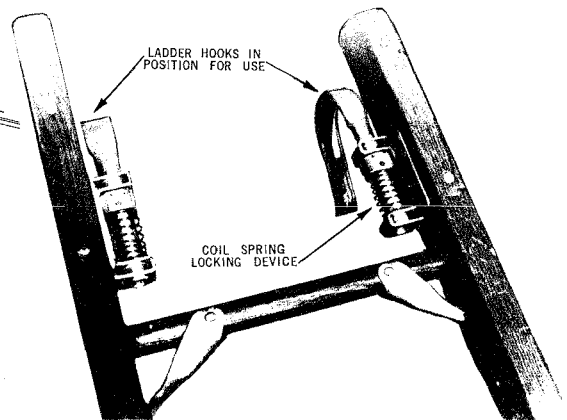
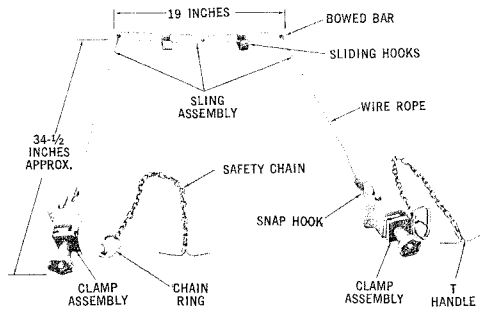


Fig. 14 — Ladder Hooks

*Caution: When using ladder hooks on aerial cable, make certain the ladder is placed on firm and level footing to prevent the ladder from twisting or sliding along the strand.*

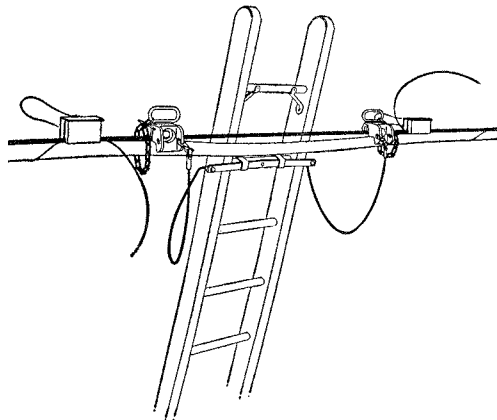
#### Ladder Supports

- 6.14 The use of the B Ladder Support or C Ladder Support in supporting the upper end of the ladder permits the craftsman to sit or stand between the ladder and the cable.
- 6.15 The *B Ladder Support* consists of a sling assembly and two clamp assemblies which are grooved to fit the strand. The clamps can be attached to the strand of either lashed or ring-supported cables, without disturbing the cable. The clamps are equipped with safety chains to prevent them from falling in the event of accidental disengagement. The sling assembly consists of a bowed bar equipped with two sliding hooks and two wire ropes, one at each end of the bar. Each wire rope terminates in a snap hook which connects the rope to a clamp assembly. The B Ladder Support is shown in Fig. 15.



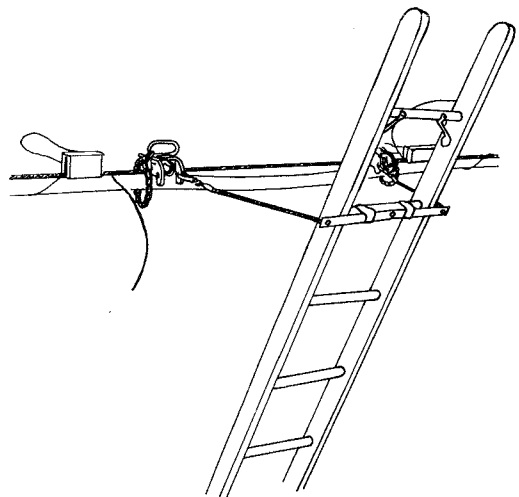
**Fig. 15 — B Ladder Support**

**6.16** To use the B Ladder Support, place the ladder against the strand and secure the bar of the sling assembly to the back of the ladder on the second rung from the top of the ladder by pushing the hooks toward the side rails until the hooks bind on the rung. Attach the clamp assemblies to the strand, as illustrated in Fig. 16. Place the safety chains around the strand to prevent the ladder from turning in the event a clamp becomes accidentally disengaged.



**Fig. 16 — B Ladder Support Attached to Strand**

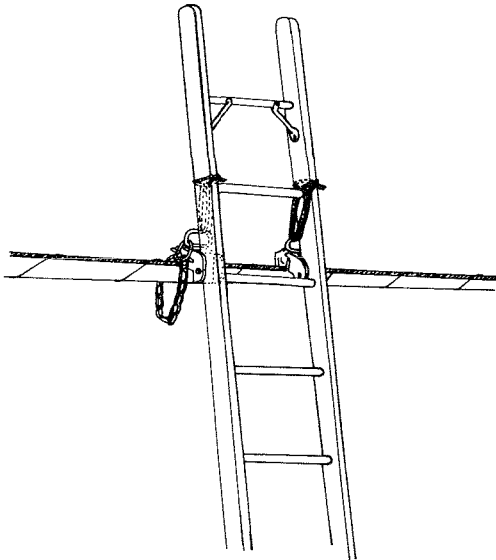
**6.17** Descend and pull the foot of the ladder backward until the top of the ladder falls below the strand and cable. This may also be accomplished by lowering the ladder with the ladder rope. Push the foot of the ladder forward and adjust its length or raise the ladder with the ladder rope until the ladder assumes the position shown in Fig. 17. Place the ladder so that the distance from its base to a line extended vertically from the sling assembly bar is about one-fourth of the length of the ladder, measured from its base to the sling assembly bar.



**Fig. 17 — B Ladder Support In Use**

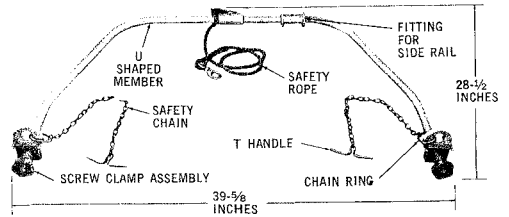
**6.18** Remove the support by reversing the procedures shown in Paras. 6.16 and 6.17.

**6.19** The clamp assemblies of the B Ladder Support may be used to attach an extension ladder to the strand. The large loop on the top edge of the clamp provides a means for lashing the ladder to the clamp with 1/2-inch manila rope. The rails of the ladder are placed in the channels of the clamps to hold the ladder away from the cable. Fig. 18 shows the method of using the clamp assemblies to attach an extension ladder to the strand.



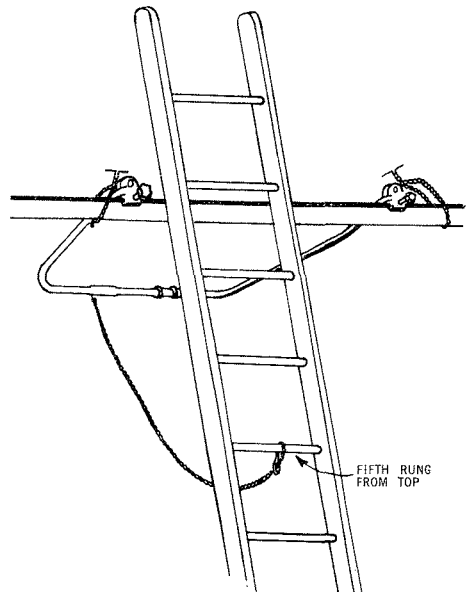
**Fig. 18 — Ladder Attached to Strand with B Ladder Support Clamps**

**6.20** The *C Ladder Support* is illustrated in Fig. 19. It consists of two screw clamp assemblies grooved to fit the strand and permanently attached to a U-shaped member made of aluminum alloy pipe. The clamps are equipped with chains for encircling the cable and strand as an added safety measure. The U-shaped member is for rigidly supporting the ladder away from the strand. A rope, attached to the centre of the member, is tied to a rung of the ladder as a safety measure while placing the ladder in the support. The U-shaped member is also equipped with a fitting to receive one side rail of the ladder for locating the ladder centrally in the support. The grooves in the clamps permit attaching the support to either lashed or ring-supported cable without disturbing the cable.



**Fig. 19 — C Ladder Support**

**6.21** To use the *C Ladder Support*, place the ladder against the strand and attach the support to the strand on the opposite side from the ladder. Place the safety chains around the strand or cable and strand. After the clamps are tightened the support will be in the position shown in Fig. 20. Attach the rope to the fifth rung from the top of the ladder. This will prevent the support from passing over the top of the ladder when the ladder is moved as described in Para. 6.22.



**Fig. 20 — C Ladder Support in Position on Strand**

## SECTION 081-740-105CA

**6.22** Descend and pull the foot of the ladder backward until the top of the ladder falls below the strand and cable. This may also be accomplished by lowering the ladder with the ladder rope. Push the foot of the ladder forward and adjust its length or raise the ladder with the ladder rope until the ladder assumes the position shown in Fig. 21 with the right side rail placed in the fitting on the support.

**6.23** Climb the ladder, detach the rope from the fifth rung, and use it to tie the ladder support member to the second rung from the top, as shown in Fig. 21.

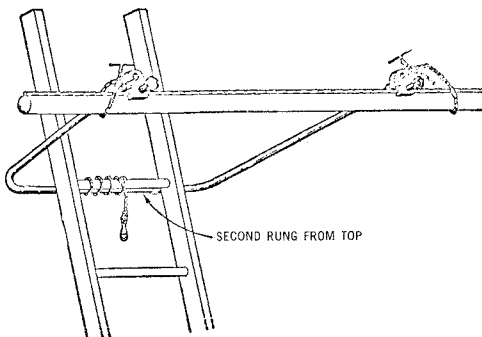


Fig. 21 — C Ladder Support in Use

**6.24** Remove the support by reversing the procedures outlined in Paras. 6.21, 6.22, and 6.23.

## 7. RAISING AND LOWERING

**7.01** The following is a one-man method of raising a 24- or 28-foot ladder to a suspension strand. It may also be used, when two craftsmen are available, for raising longer ladders to the strand. This method of handling ladders keeps the ladder under control at all times, and provides a temporary lashing to the strand before climbing.

**7.02** Where ground conditions allow, place the ladder on the ground, with the top section

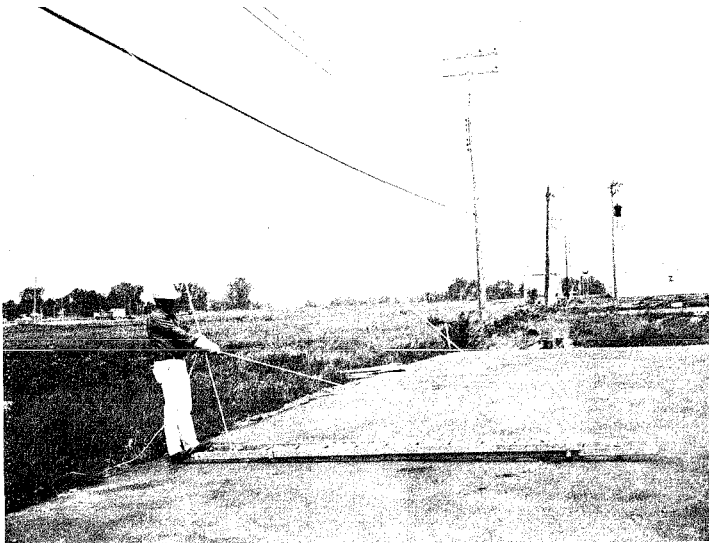
down at a right angle to the suspension strand with the base of the ladder directly under the location of the work. Ladders of 24- or 28-foot lengths can be extended, while lying on the ground, to within a few feet of the vertical height of the strand before raising the ladder. Ladders of greater length should be extended only two rungs. Secure the two sections by tying the ladder rope around the bottom rung of the top section and the adjacent rung of the bottom section with a clove hitch.

**7.03** Where ground conditions do not permit placing the ladder as outlined above (ie., where the end of the ladder would interfere with traffic on a road or street), the base of the ladder can be moved back from its position under the work location as required. *It can also be placed parallel to the suspension strand* with the base directly under the work location. In either of these positions, extend the ladder only two rungs.

**7.04** Throw a handline ( $\frac{3}{8}$ -inch or larger) over the strand at the location where the ladder will be supported. If there is a possibility of the handline becoming involved with tree branches, power wires, etc., place the handline over the strand with tree pruner handles, taking care to avoid contact with power wires. In doing this, exercise care to prevent the free end of the handline from interfering with passing vehicles.

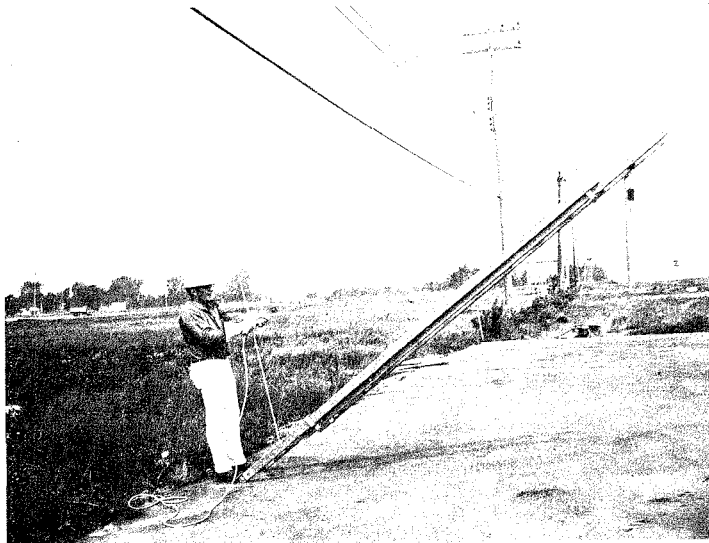
**7.05** Tie the near end of the handline to the bottom rung of the ladder, using a clove hitch and two half-hitches or a block becket bend (Section 081-510-101). Take the other end of the handline to the top end of the ladder. Check the handline where it passes over the strand to see that it does not cross over itself and pass the free end behind the second rung from the top and then out on the top side of the ladder.

**7.06** Carry the free end of the handline to the base of the ladder and stand with balls of the feet on each side rail to block movement of the ladder base to the rear (Fig. 22). When raising the ladder parallel to the strand removing the left foot from the side rail will make the ladder swing to the right. Removing the right foot will make it swing to the left.



**Fig. 22 — Preparing to Raise Extension Ladder**

- 7.07** Pull the handline hand over hand. As the top end of the ladder is raised off the ground, keep feet in position to block any movement of the base of the ladder to the rear (Fig. 23).

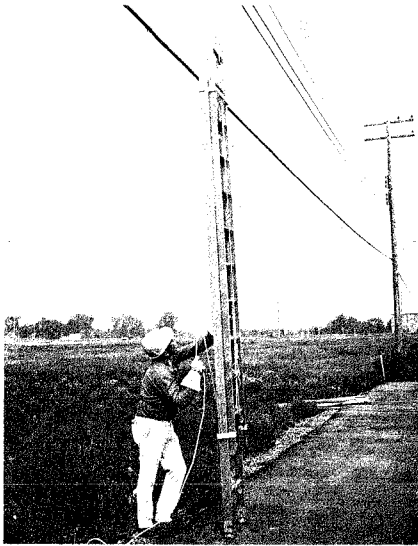


**Fig. 23 — Ladder Partially Raised**



**SECTION 081-740-105CA**

**7.08** Continue pulling the free end of the handline until the ladder is in a vertical position under the strand (Fig. 24).



**Fig. 24 — Ladder in Vertical Position**

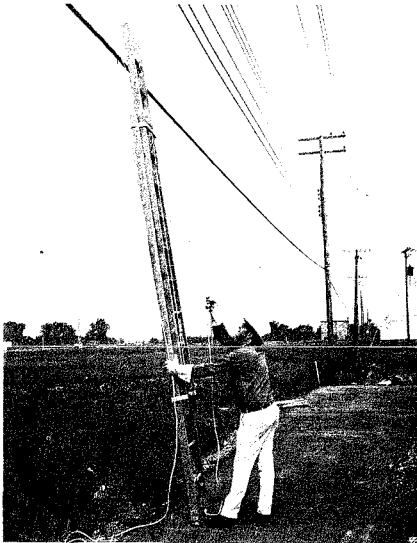
**7.09** If, as in the first part of Para. 7.03, the ladder base was not placed under the strand, the base of the ladder should now be moved directly under the strand. To do this, hold the handline taut with one hand, holding the side rail at the same time, move the base of the ladder with the other hand.

**7.10** Still holding the handline taut, walk around to the front of the ladder. If holding the handline with the left hand, walk to your right. If holding the handline with your right hand walk to your left. (See Fig. 25)



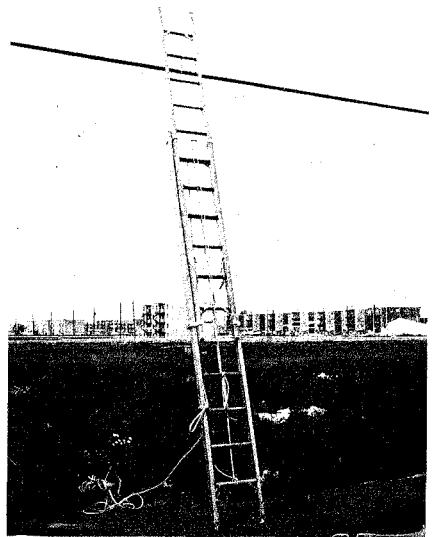
**Fig. 25 — Moving to Front of Ladder**

**7.11** Standing in front of the ladder still holding the handline taut, grab the side rail. With the free hand untie the ladder extension rope. Pull on the ladder extension rope and extend the ladder until the second rung is above the strand. (See Fig. 26)



**Fig. 26 — Extending Ladder**

**7.12** Move the foot of the ladder out to its working position allowing the top of the ladder to rest on the strand. It may be necessary to extend the ladder further to keep two rungs above the strand. When the ladder is in proper working position (1 to 4 ratio) tie the handline around the second or third rung with a clove hitch and two half hitches. (See Fig. 27) If desired, the handline may be doubled or the tie may be made around two rungs to avoid having excess rope lying on the ground. Tie the ladder extension rope in a similar way.



**Fig. 27 — Method of Securing Handline**

**7.13** When the ladder is to be lowered, the procedure is reversed. Move the foot of the ladder back under the strand. Leaving the handline over the strand tied at both ends, untie the ladder extension rope. Lower the top section until it is extended two rungs above the bottom section and secure the ladder locks. Then untie the upper of the two ends of the handline and lower the ladder gently to the ground by slowly paying out the handline. If the top end of the ladder tends to swing, move the foot of the ladder back while holding the handline securely.

**SECTION 081-740-105CA**

7.14 A 24-, or 28-foot Extension Ladder may be raised or lowered by one man in the manner shown in Fig. 28 if the foot of the ladder is

securely embedded in earth or is placed against the base of a wall, a pole, or other secure object.



**Fig. 28 — One Man Raising Ladder**

**7.15** In general, a 32-, or 40-foot Extension

Ladder should be raised with the foot of the ladder held securely by one craftsman, while a second craftsman walks the ladder up to a vertical position similar to that shown in Fig. 29. As an alternative, if the foot of the ladder can be placed against the base of a wall, one craftsman alone can raise the ladder as described in Para. 7.14.



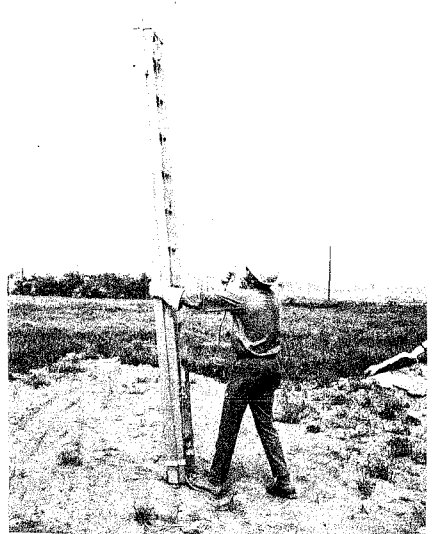
**Fig. 29 — Two Men Raising Ladder**

**7.16** In raising and lowering extension ladders it is imperative that the craftsman handling the ladder maintain a secure footing at all times.

**7.17** When lowering ladders, follow the reverse of the above procedures.

**8. HANDLING TOP SECTIONS****Raising Top Section of 28 Foot Ladders**

**8.01** After the ladder has been raised to an upright balanced position, (See Fig. 30) take a position in front of the ladder with one foot against the base to prevent it from kicking out. Place the other foot in a bracing position to the rear to provide a firm stance. Untie the ladder extension rope. The craftsman's foot at the base of the ladder reduces the possibility of the ladder slipping.



**Fig. 30 — Preparing to Extend Top Section**

**8.02** Pull the ladder rope to raise the top section two or three rungs at a time and engage the locks after each pull. Exercise care to prevent injury to the hand holding the side rail. Notice that when the rope is pulled directly down the middle, there is not the same tendency to pull the ladder over too far to an unstable position.

**8.03** After locking the top section, allow the top of the ladder to move slowly toward the support. After the ladder is in place against the support, tie the ladder rope securely to one of the rungs of the bottom section with a clove hitch and two half-hitches.

## SECTION 081-740-105CA

### Lowering Top Section of 24 to 28 Foot Ladders

8.04 The preferred method for lowering the top section of 24, and 28-foot extension ladders is as follows.

- (a) Untie the ladder rope.
- (b) Block the ladder at the base with one foot, then grasp the side rails and pull the top of the ladder back and away from the support until it is in an upright balanced position as shown in Fig. 31.

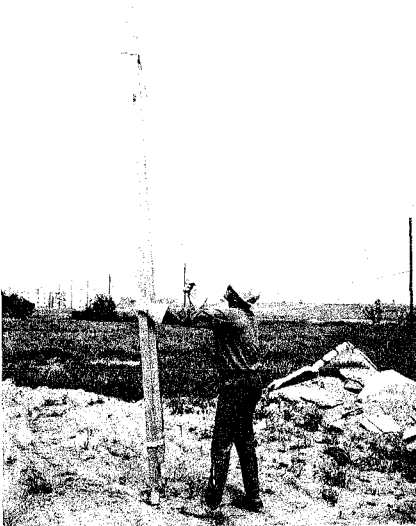


Fig. 31 — Extending Top Section

- (c) While holding the bottom section side rail with one hand, raise the upper section about 6 inches by means of the ladder rope in order to release the ladder locks. Then **allow the upper section to descend slowly** by applying the necessary drag on the rope. The drag

on the rope should hold the ladder in the balanced position. Exercise care to prevent injury to the hand holding the side rail. Do not allow the top section to strike the ground or pavement sharply.



Fig. 32 — Top Section Extended

### Raising and/or Lowering Top Section of 32- to 40-Foot Ladders

8.05 One craftsman shall hold the side rails of the lower section on the back side of the ladder during the raising and lowering of the upper section by another craftsman. Exercise care to prevent the ladder guide irons from striking and injuring the hands of the craftsman holding the side rails. The positions to be taken by the craftsmen are shown in Fig. 33. The ladder is raised by the second craftsman.

## 9. TRANSPORTING

### On Motor Vehicles

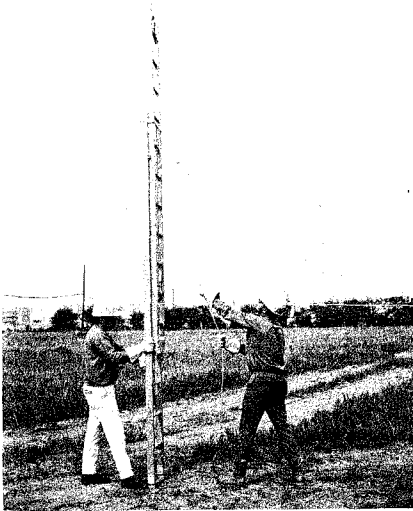


Fig. 33 — Two-Man Method of Extending Top Section

**8.06** The craftsman holding the ladder shall keep his feet and legs clear of the side rails and bottom rung of the upper section while it is being lowered. The craftsman lowering the top section shall check its downward movement with the ladder rope so that the top section does not strike the ground or pavement sharply.



*Ladders equipped with New Type Spring Lock shall not be lowered by free fall. The mechanism of these locks cannot operate at such a speed and may catch a lower rung of the bottom section and thus crack or break this rung.*

**9.01** When transporting 32 or 40 foot ladders on trucks or other motor vehicles, always fasten them securely in their proper position with straps or other devices provided for the purpose. Never use wire for securing a ladder to the brackets of a truck. A ladder hanging loosely on the brackets of a truck will soon be marred, cracked and weakened by road shocks. Use the required warning signals.

**9.02** When the motor vehicle is equipped with a roof bracket to transport 24 and 28 foot ladders, place the ladder on the bracket as follows:

- (1) Place the ladder against the vehicle.
- (2) Assume a position at the side of the vehicle, facing the rear, with the back of the ladder adjacent to the vehicle.
- (3) Lower the base of the ladder to the ground and position the top portion of the ladder behind the rolled upright portion of the outside side rail assembly as shown in Fig. 34.
- (4) Raise the base of the ladder and place it in position in the ladder bracket.
- (5) Lock the ladder in place as shown in Fig. 35.

For removing the ladder from the truck reverse the procedure listed above. Caution must be exercised not to drop the foot of the ladder as this will damage the spurs.

**Note:** The steps outlined in Para. 9.02 are for a typical roof-mounted ladder bracket. Other types of ladder brackets are available and the method of placing ladders in these brackets may vary.



- NOTES: 1. LADDER LOCKING CLAMPS MAY BE ADJUSTED TO ACCOMMODATE THREE DIFFERENT LADDER SIZES.
2. IF A LADDER IS EQUIPPED WITH SPURS, IT SHOULD BE POSITIONED ON THE LADDER BRACKET IN A MANNER THAT WILL ENSURE MAXIMUM SAFETY.

**Fig. 34 — Placing Ladder on Roof-Mounted Ladder Bracket**



**Fig. 35 — Ladder Locked in Position on Roof-Mounted Ladder Bracket**

**9.03** Care should be taken by the drivers of motor vehicles carrying ladders to avoid letting the ladders strike trees, posts, walls, or other objects, especially when backing or turning corners. If it is known that the ladder has been subject to a shock, make a careful inspection of the ladder, before it is used, in accordance with Part 10.

**9.04** If an extension ladder extends an abnormal distance beyond the rear of a motor vehicle, attach a warning flag or light to the projecting end of the ladder.

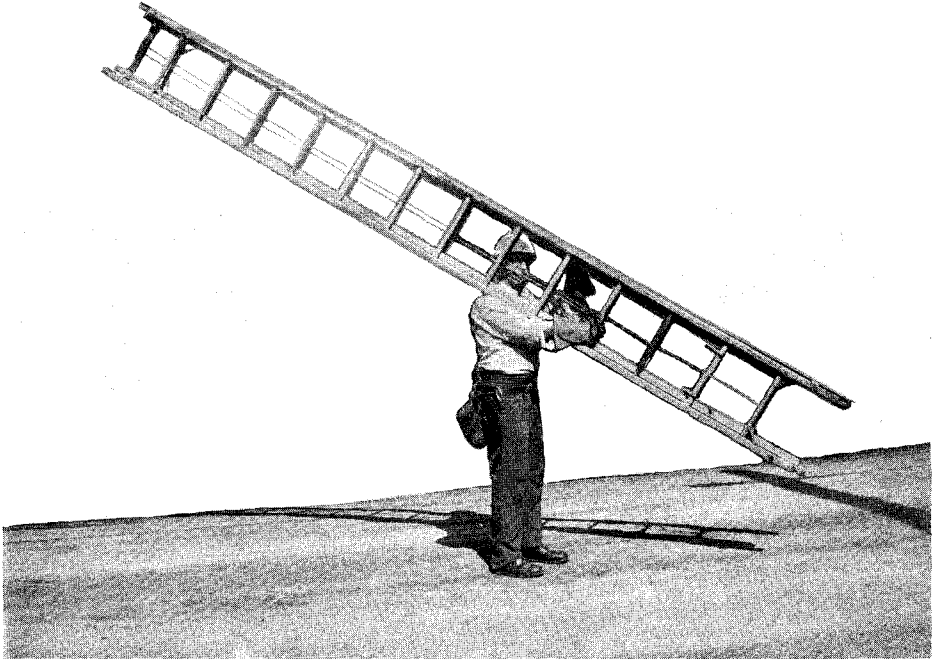
**One Man Method**

**9.05** Carry extension ladders in the closed position with the spurs downward and to the front and ladder hooks, if present, rotated into the

plane of the rungs between the side rails. Secure the end of the ladder rope by tying it with a clove hitch around one rung of the top section and the adjacent rung of the bottom section.

**9.06** To carry an Extension Ladder, first place it in the vertical position with the side rails of the bottom section on the outer side. Tilt the ladder until the bottom section side rail rests

against the chest and shoulder, then lift the ladder to the shoulder until the exact point of balance is obtained. The spurs of the ladder should be approximately 18 inches from the ground, if the overhead conditions permit this method. In the event of a gust of wind the ladder could be quickly braced in the ground and prevent swinging. The proper carrying method is shown in Fig. 36.



**Fig. 36 – One-Man Method of Carrying Ladder**



**SECTION 081-740-105CA**

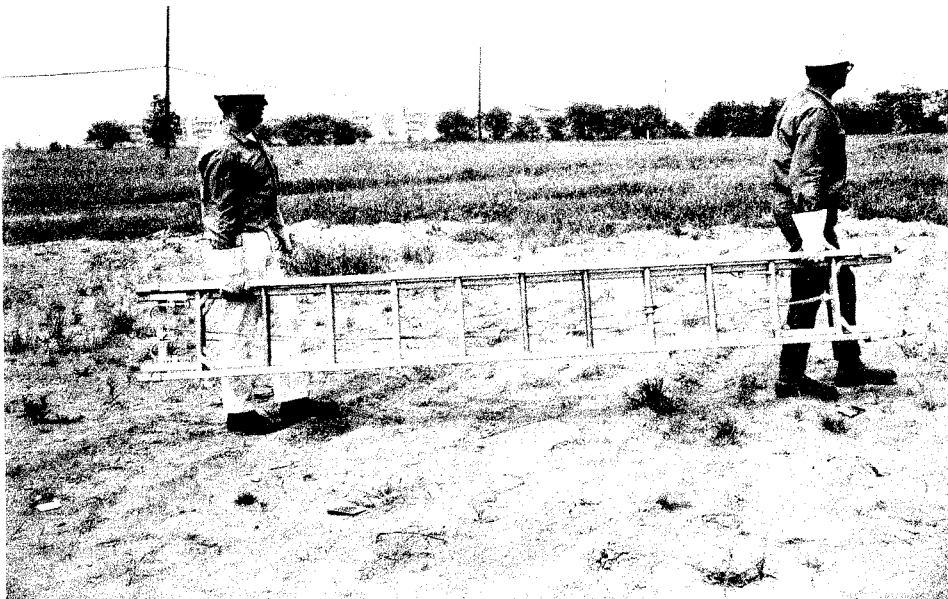
**9.07** Do not lift or carry a ladder by grasping the ladder rope.

**Two Man Method**

**9.08** Before carrying the ladder, secure the free end of the ladder rope with a clove hitch around one rung of the top section and the adja-

cent rung of the bottom section. Rotate the ladder hooks, if present, into the plane of the rungs, between the side rails.

**9.09** To pick up a ladder, the two men take positions at opposite ends and, lifting together, lift the ladder to the position shown in Fig. 37. Carry the ladder with spurs forward.



**Fig. 37 – Two-Man Method of Carrying Ladder**

## 10. INSPECTION OF EXTENSION LADDERS

### Inspection Routine

**10.01** Each person using a ladder shall determine that it is in good condition and that its appearance indicates neither deterioration nor damage sufficient to affect its strength. Ladders not in storage shall be examined visually once each week as outlined in Paras. 11.01 through 11.09. Should such examination reveal a split, splinter etc., in a side rail, the sections shall be inspected as outlined in Paras. 10.06 through 10.10. The sections shall also be examined under the prescribed dead-weight load inspection *in the event the ladder has been dropped* or has otherwise been abused or damaged or every 6 months.

**10.02** The definitions of some terms used in inspecting ladders are as follows:

- **Cracks** are fractures across the lengthwise fibers of the wood resulting usually from mechanical stresses.
- **Decay** is disintegration of the wood due to action of wood-destroying fungi.
- **Splits** are lengthwise separations of the wood extending in the direction of the grain.

**10.03** The inspection of extension ladders shall be made when the wood is dry. Absorption of considerable moisture causes swelling which tends to conceal defects.

**10.04** The supervisor shall inspect the ladders used by his forces at least every two months. Inspection under dead weight load may be omitted in this inspection.

**10.05** The supervisor shall see that the craftsmen comply with the inspection routine.

### Method of Inspection

**10.06** Examine the ladder to determine the condition of all of its parts. In order to facilitate careful inspection, place the ladder at a convenient height in a well lighted area. *If any defects are found which cannot be taken care*

*of by the craftsman or if the condition is such that there is doubt about the ladder being safe to use, exchange it at once, in accordance with local routine, for one in good condition.*

### Dead Weight Test

**10.07** Separate the ladder sections and place *one section at a time* on two supports located a few inches from the ends of the side rails. These supports should be of a height which will permit the craftsman to examine the underside of each rail thoroughly.

**10.08** Place a weight of approximately 100 pounds (3 coils of drop wire) at a point approximately 2 feet from one end support. The weight should be supported approximately evenly by the two side rails. Examine the under edges and the faces of each rail carefully for signs of the defects described in Paras. 11.01 through 11.09. Particular attention should be given to the points where the rungs are joined to the side rails, as these are points where fractures are most likely to occur.

**10.09** Repeat the operation in Para. 10.08 with the weight placed at the midpoint of the ladder section and again with the weight placed about 2 feet from the other support.

**10.10** Turn the section over and repeat the inspections outlined in Paras. 10.08 and 10.09 above. *The suggested loading is not a strength test of the section, but rather a means for disclosing defects and, therefore is of no significance unless a careful visual examination is carried out while the section is under load.* Under no circumstances shall an *extended* ladder be inspected in this manner nor shall a weight appreciably in excess of the specified 100 pounds (such as the weight of a person) be applied to a ladder section being inspected.

## 11. DEFECTS TO LOOK FOR ON LADDER RAILS

**11.01** Look for damage to the rails which may appear as a fine crack, as a fold or crease in the wood fibers, or as a splintering of the wood fibers. Such defects are usually caused by over-

loading the ladder or subjecting it to a hard blow either by dropping or through some other accident and may subsequently result in failure of the ladder under normal load. Cracks or fine wrinkles (compression failure) in the wood fibers are most likely to occur at rung positions and a very careful inspection is usually required to detect them. In most instances the wrinkles or creases appear alone, but in some cases there may also be some splintering of the wood fibers in the opposite side of the rail (Fig. 38).

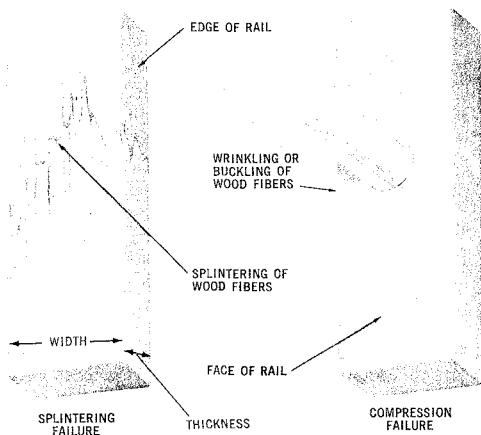


Fig. 38 — Defects in Side Rails

**11.02** Splits that extend into an edge of a side rail and cannot be removed by dressing without reducing the original rail thickness by more than  $\frac{3}{8}$ -inch are cause for rejection.

**11.03** Splits extending from one face of the rail through to the opposite face or that result in loosening of rungs are cause for rejection.

**11.04** Badly splintered rails that would require the original width of the rail to be reduced more than  $\frac{1}{2}$ -inch by dressing to remove the projecting fibers are cause for rejection. Remove all splinters as they appear and dress the rail with a wood rasp, file, knife, sandpaper, or other suitable means.

**11.05** Worn, crushed, or excessively indented rails are cause for rejection.

**11.06** Decay, particularly where rungs join side rails, is cause for rejection.

**11.07** Check for excessive longitudinal play in side rails (more than  $\frac{3}{4}$ -inch or the width of the thumb). This is due to looseness of the rungs and rung braces and may be measured as shown in Fig. 39.

**11.08** Check for protruding nails. These shall be driven flush.

**11.09** Check for deteriorated finish, (without finish, ladder can absorb up to 11 lbs. of water).

## 12. DEFECTS TO LOOK FOR ON LADDER RUNGS

**12.01** Check for broken, loose, cracked, split, badly splintered, decayed and excessively worn rungs. Some of these defects may not be visible but may be detected by rapping the rung with a hammer handle and comparing the sound with that obtained from striking other rungs. Do not strike rungs with head of hammer. A bad rung will have a distinctive sound. It will be necessary to closely check to determine the cause. A rung is considered loose if there is more than  $1/32$ " rotation.

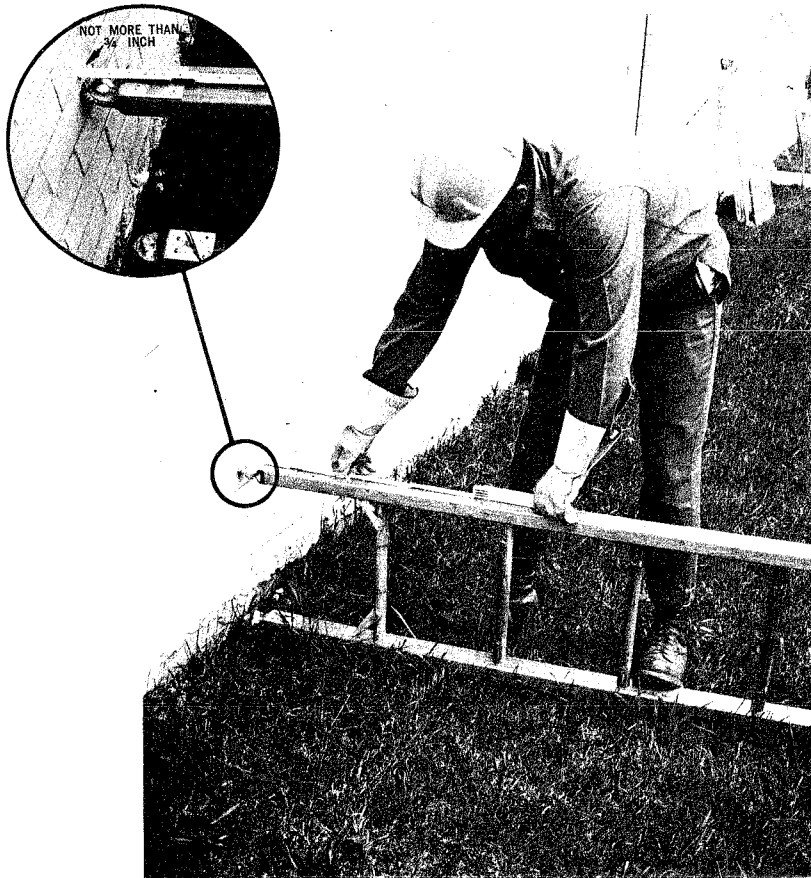
## 13. DEFECTS TO LOOK FOR ON LADDER FITTINGS

**13.01** Broken, badly bent or cracked guide irons.

**13.02** Loose rivets.

**13.03** Broken ladder locks or improper action of the locks (Fig. 41-42).

**13.04** Excessively worn, seriously frayed or rotted ladder ropes. Test the rope by laying the ladder on the ground. Make sure that the rope is well tied to a lower rung. Stand on two rungs near the centre of the ladder. Grab one side of the rope and pull on it, as hard as you can. (See Fig. 40) If the rope passes this test, untwist it every 3 feet and look for signs of rotting, mildew and decay.



**Fig. 39 — Measuring Longitudinal Play in Side Rails**

- |   |  |
|---|--|
| <p><b>13.05</b> Broken, cracked or badly distorted rotatable ladder hooks.</p>          | <p><b>13.09</b> Defective or missing ladder stops on 32 and 40 foot ladders.</p> |
| <p><b>13.06</b> Badly worn, frayed or damaged pole grip.</p>                            | <p><b>13.10</b> Deteriorated finish</p>  |
| <p><b>13.07</b> Broken, cracked or defective braces.</p>                                | <p><b>13.11</b> Bent, worn or dull spurs.</p>                                    |
| <p><b>13.08</b> Broken or defective pulley. The pulley sheave shall revolve freely.</p> |  |

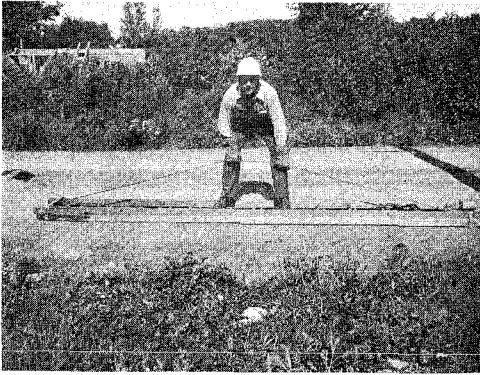


Fig. 40 — Testing Ladder Rope

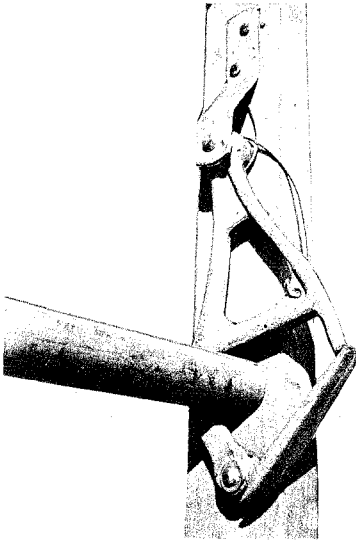


Fig. 41 — Old Type Spring Lock

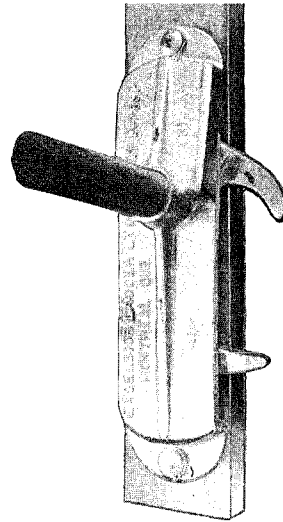


Fig. 42 — New Type Spring Lock

#### 14 FIELD REPAIRS

- 14.01 Following are repairs that can be made by the workman in the field.
- 14.02 Side rails may be redressed as indicated in Para. 11.04.
- 14.03 Loose rungs may be repaired by driving a 1½" finishing nail through from the underside of the rail.
- 14.04 Bent guide irons may be straightened with a hammer. Check afterward to ensure that the guide irons are not cracked.
- 14.05 Loose rivets may be tightened by peening.

**14.06** Tight ladder locks should be oiled. If the tightness is caused by the swelling of the wood, the rivet holding the lock can be countersunk slightly to free the lock. This should be done only when the wood is wet.

**14.07** Replace ladder ropes.

**14.08** To adjust a worn or dull wheel spur, remove the nut, lockwasher and shoulder bolt. Rotate the wheel 90 degrees, bringing the unused portion of the wheel in position for use. Replace the bolt with the shoulder properly seated in the plate and wheel. Replace the lockwasher and the nut and tighten securely. (See Fig. 43) Do not change the position of a wheel spur on only one side; always change both, even though one is not badly worn.

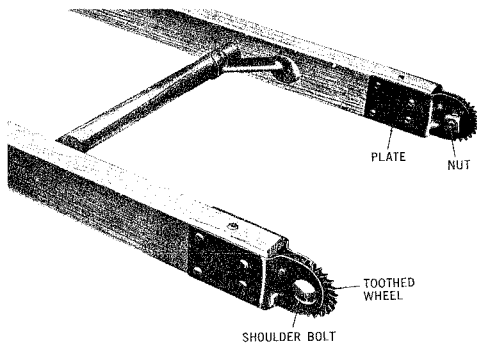


Fig. 43 — Wheel Spurs

**14.09** Bent spur brackets may be straightened by a few blows with a hammer. Check to make sure that no cracks on the spur bracket have occurred while repairing.

**14.10** Keep ladders free from dirt, paraffin, oil, tar, etc., where practical. A paraffin coating on wood is slippery and may cause an accident. To remove paraffin from the ladder, first scrape the excess off with a shave hook or other edged tool and then rub the surface vigorously with a rag moistened with B Cleaning Fluid.

## 15. STORAGE OF LADDERS

**15.01** Ladders that are not being used shall be stored where they will not be exposed to the elements but where there is good ventilation. Never store ladders near radiators, stoves, steam-pipes, or in places where the wood may be subjected to excessive heat or dampness. Such conditions bring about extreme changes in the moisture content of the wood causing the wood to split or crack, and the rungs and hardware to become loose.

**15.02** Store ladders to provide ease of access for inspection and to prevent danger of accident when withdrawing a ladder for use.

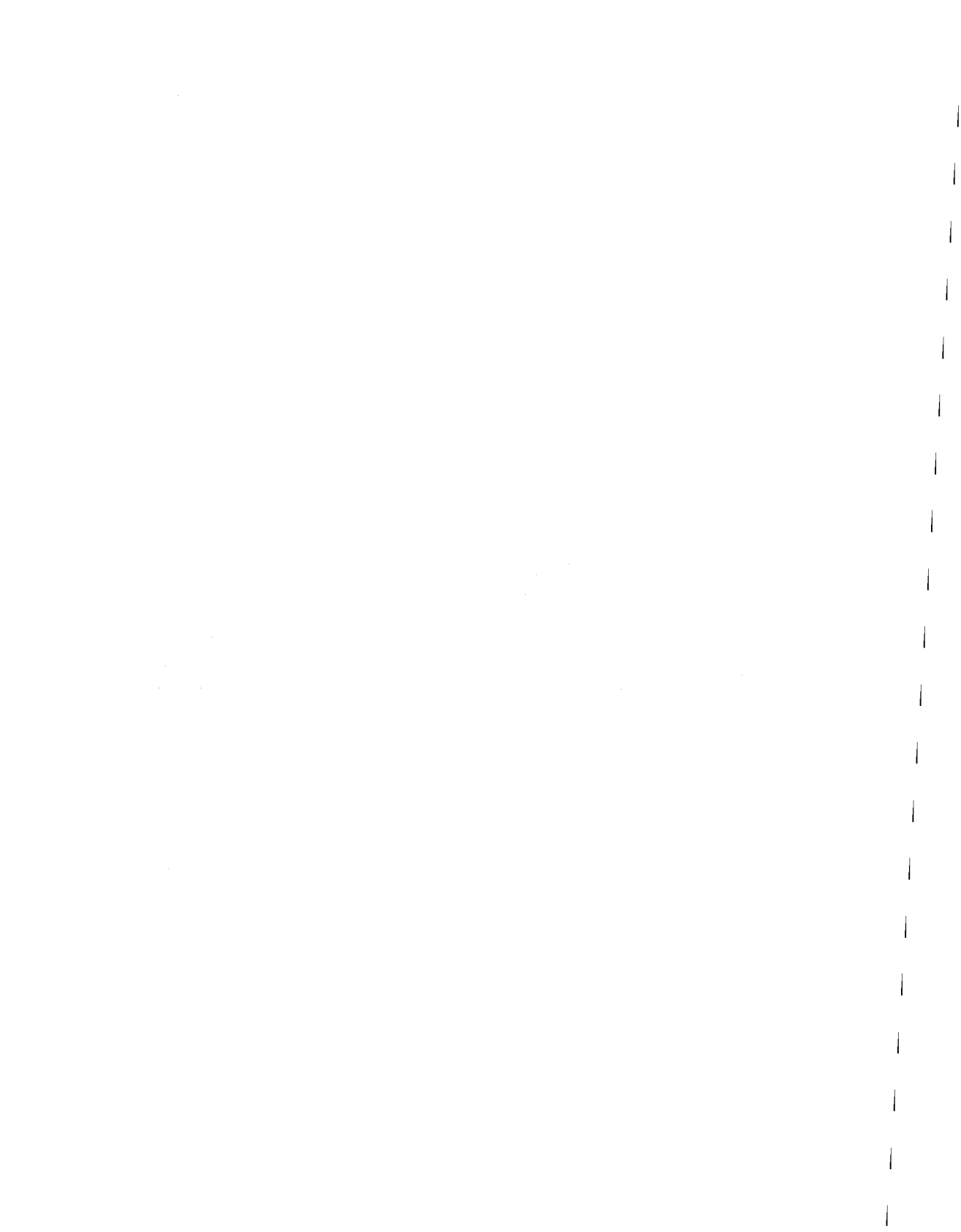
**15.03** Where ladder racks have not been provided, store ladders in vertical position. Where this is not practical, lay the ladders in a horizontal position, one on the other. Place wooden spacers between the floor and the lower ladder and between ladders to prevent side rails from becoming damaged by guide irons. Do not store ladders in any position where there is a chance of pressure being placed on them that might cause warping or twisting. Not more than six ladders should be placed in one stack. Heavy objects shall not be permitted to rest on ladders in storage.

**15.04** Ladders stored in a horizontal position should be supported at a sufficient number of points (at least 3 points for 20- and 24-foot ladders and 4 points for the longer ladders) to avoid sagging and permanent set.

## 16. DISPOSITION OF DEFECTIVE LADDERS

**16.01** Sections of ladders which have developed major defects shall be removed from service for repairs or destruction. Craftsmen in the field shall see that such ladder sections in their possession are returned to the storeroom tagged or marked *Dangerous, Do Not Use* and, if practical, the ladder shall be marked to show the location of the defect. Ladders required in connection with an investigation that may be made to determine the cause of an accident or a ladder failure should be kept in the storeroom.

**16.02** Good sections of ladders that have been tagged defective **MUST NOT** be matched to make a new ladder.



## Z VOLTAGE TESTER

	CONTENTS	PAGE
1.	GENERAL . . . . .	101
2.	DESCRIPTION . . . . .	101
3.	TESTING THE Z VOLTAGE TESTER . . . . .	102
4.	MAINTENANCE . . . . .	103
5.	USE . . . . .	104
6.	CARE AND STORAGE . . . . .	104

### 1. GENERAL

1.01 This section describes the Z Voltage Tester and its associated tools. It also provides information on its maintenance, use and care.

1.02 Detailed information on the testing procedures prior to climbing poles or performing certain work functions are covered in the appropriate Divisions. This section cancels section 620-105-960CA.

### 2. DESCRIPTION

2.01 The Z Voltage Tester is designed to detect the presence of voltages from 60 volts to 7200 volts. It consists of an indicator assembly which contains a small neon glow unit and reflector and a plastic insulated tube equipped with a replaceable probe assembly on one end for making contact with the conductor, conduit or street light fixture to be tested. Resistors inside the tube are included to limit the amount of current which can pass through the device. The tube, indicator assembly and an insulated clip are connected by insulated cord as illustrated in Fig. 1.

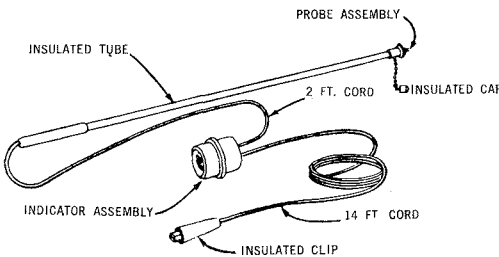


Fig. 1 — "Z" Voltage Tester

2.02 At 60 to 70 volts the indicator of the Z Voltage Tester glows dimly. Higher voltages will produce a brighter glow. Because the higher voltages can damage the tester if left connected (7200 volts will burn it out in approximately one minute) it should be touched to the facility being tested **only long enough to determine whether or not the indicator glows.**

2.03 A TCS871 Voltage Plug, as illustrated in Fig. 2 is available to provide a safe and convenient means for checking the operation of the Z Voltage Tester. When plugged into any standard 110- to 120-volt convenience outlet, it provides a source of voltage in series with a current limiting resistor. As illustrated, the resistor is connected to only one prong of the plug and this prong must be plugged into the "hot" side of the outlet.

150,000 OHM, 1/2 WATT RESISTOR

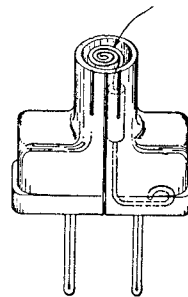


Fig. 2 — TCS871 Voltage Plug

2.04 The B Shunting Capacitor is required to prevent false operation of the tester under certain conditions when testing street light fixtures.

2.05 False operation of the tester generally is due to the capacitance coupling between the internal wiring of the fixture and the metal conduit. It is most likely to occur on series fed street light fixtures. If when testing light fixtures with the Z Voltage Tester only, there is an indication of energization it will be necessary to



determine the nature of the energization either by using the B Shunting Capacitor as described below or by referring the case to the electrical utilities for verification.

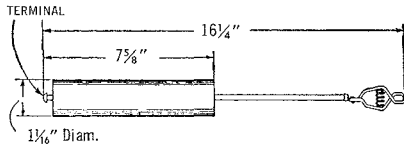


Fig. 3 — B Shunting Capacitor

2.06 The Z Temporary Bond Fig. 4 is an insulated stranded copper wire 5 feet long equipped with a battery clip on each end.

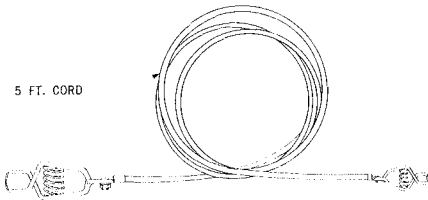


Fig. 4 — Z Temporary Bond

3. TESTING THE Z VOLTAGE TESTER

3.01 The Z Voltage Tester should be tested weekly to ensure that it is operating satisfactorily.

3.02 The method of testing the Z Voltage Tester is as follows:

- (a) Locate a standard 110- to 120-volt convenience outlet which is energized. This may be checked with an extension cord and lamp.
- (b) Insert the voltage plug, described in Para. 2.03, into the outlet; first choose the smaller of the two slots in the outlet to insert the prong connected to the resistor.
- (c) Attach the insulated clip of the voltage tester to a ground such as a water pipe, radiator, metallic power conduit, etc. If none of these are available, lay the Z Temporary Bond, uncoiled, on the floor and attach to one of its clips.
- (d) Grasp the grip of the voltage tester in the palm of the hand so that the end of the

grip extends almost to the forefinger with the wire passing between the thumb and forefinger. (See Fig. 5.) With the thumb and forefinger bent, pinch the wire firmly. Hold the grip as firmly as possible with three fingers, and while keeping the wire firmly pinched, straighten the thumb and forefinger—thus putting tension on the wire. DO NOT USE BOTH HANDS AND PULL OR JERK ON THE WIRE SINCE EVEN A NORMAL CORD MAY BE DAMAGED OR BROKEN IF IT IS SUBJECTED TO VIOLENT PULLING.

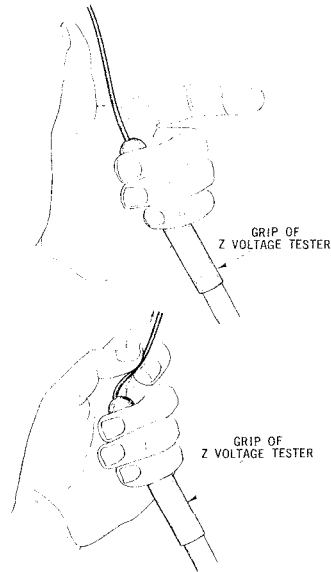


Fig. 5

- (e) Touch the toothed metal disk of the probe to the metal spiral of the voltage plug. The indicator should glow faintly. If the indicator does not glow, release the tension in the wire, but keep the probe in contact with the voltage plug. If the indicator glows after the tension has been released, the wire is broken under the insulation and the tester should be disposed of in accordance with the Company's established routine.
- (f) If the indicator does not glow, reverse the voltage plug in the outlet by removing it,

turning a half-turn and inserting again into the outlet, and repeat the test.

(g) If the indicator still does not glow, and it is known that the convenience outlet is not defective, then the voltage tester must be defective and shall be disposed of in accordance with the Company's established routine.

#### 4. MAINTENANCE

**4.01** Testers which cannot be repaired by using the methods described in this section should be disposed of in accordance with company's established routine.

##### Wire Insulation Breaks Near the Probe

**4.02** Experience has shown that after extensive use under certain conditions, the insulation of the wire coming out of the probe handle or grip of the Z Voltage Tester, may crack and expose the bare wire. This is not dangerous, but because the wire will tend to bend much more sharply at the point where the wire is exposed, it will eventually break at this point. The following procedure is designed to prevent wire breakage at this point.

**4.03** Clean the grip with a cloth (moistened if necessary with soap and water) to remove mud, grease and other foreign matter; dry it thoroughly before proceeding with repairs.

(a) Lay the wire snugly against the grip as shown in Fig. 6(1).

(b) Apply  $\frac{3}{4}$ -inch (or 1-inch) D Vinyl Tape or friction tape along the grip and over the wire as shown in Fig. 6(2).

(c) Starting at the middle of the grip, wrap tape around the wire and grip lapping each turn about  $\frac{1}{8}$  inch over the preceding turn. Continue the wrapping to the end of the grip and back to the other end of the grip, finally ending at the middle. This will result in a double layer of tape from one end of the grip to the other. The completed repair is shown in Fig. 6(4).

**4.04** The preceding repair should not be made, however, if the wire between the probe and the indicator assembly has previously been field spliced, or is broken, as the wire will be too short.

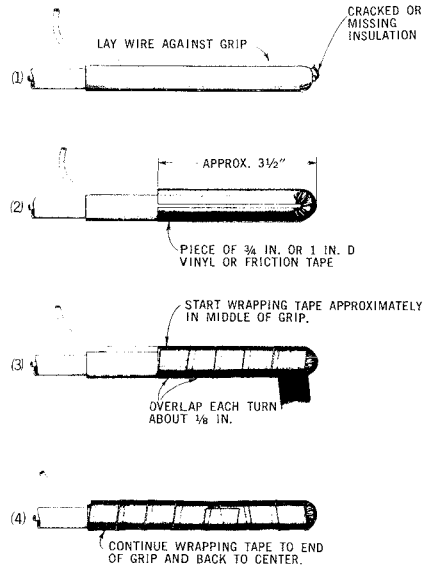


Fig. 6 — Taping Wire To Handle

##### Wire Splices

**4.05** The wire or cord of the Z Voltage Tester may be spliced under the following conditions:

(a) Between the probe and the indicator assembly, a maximum of two splices are permitted unless it is also necessary to tape the wire to the grip in which case no splices are permitted in this piece of cord. Do not attempt to splice wire if the break is within 4 inches of either the indicator assembly or the grip of the probe.

(b) Between the indicator assembly and the grounding clip, a maximum of three splices are permitted except that no attempt should be made to splice wire breaks within 4 inches of the indicator assembly, and no attempt should be made to splice wire breaks if the over-all length of the cord between the clip and the indicator assembly will be less than 7 feet 6 inches. Each splice will reduce the length of the cord about 2 inches.

**4.06** Broken cords shall be spliced as illustrated in Fig. 7 and explained:

## SECTION 106-220-925CA

- (a) Strip 2 inches of insulation from the wire on each side of the break using the wire stripping hole of the standard 6-inch diagonal pliers.
- (b) Clean the insulation of the wire adjacent to the break for a distance of at least an inch to remove mud, grease, etc.
- (c) Tie a square knot in the middle of the exposed wire so that the ends will lie parallel and extend approximately to the beginning of the insulation.
- (d) Tape the joint with  $\frac{3}{4}$ -inch D Vinyl or friction tape. Start the tape at about a 45-degree angle beginning at the knot and continue until about  $\frac{1}{2}$  inch of the rubber insulation has been covered. Continue taping until the splice has two layers, ending the tape in the middle of the splice.

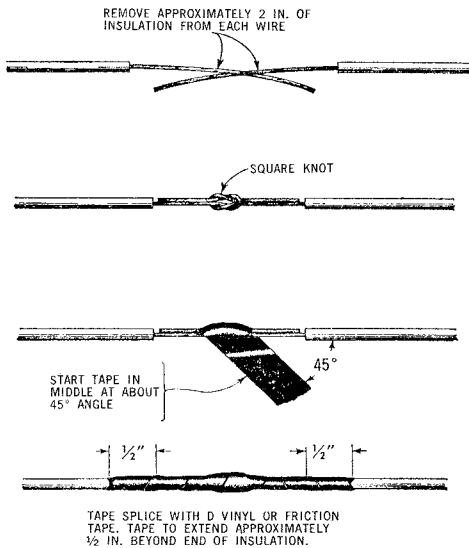


Fig. 7 — Splicing Wire

### 5. USE

- 5.01 The Z Voltage Tester is used to detect potential power hazards on:
  - (a) Vertical power ground wire.

- (b) Vertical metallic power conduit.
- (c) Street light fixture.
- (d) Joint-use terminal.
- (e) Neutralizing transformer installations.
- (f) Any other occasion where foreign voltage is suspected.

### 6. CARE AND STORAGE

6.01 A canvas bag has been provided to carry and store the Z Voltage Tester, Z Temporary Bond and B Shunting Capacitor when not in use. A web strap with dee ring and snap hook is provided to attach the bag to the body belt. In placing the tester in the bag, place the toothed metal disk first. The capacitor and bond should be carried in lower pocket of bag. The test date card is carried in the plastic pocket provided for this purpose.

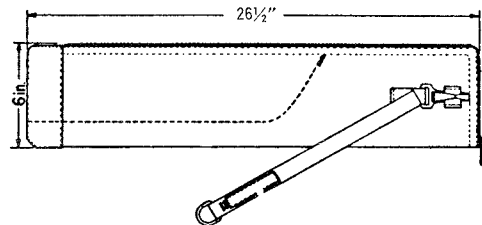


Fig. 8 — Z Voltage Tester Bag

- 6.02 The Z Voltage Tester should be handled and stored with reasonable care. Remove any dampness or dirt with a clean cloth before using or storing. Keep the instrument free of grease or oil to prevent deterioration of insulation.
- 6.03 Avoid exposing the instrument to excessive heat such as may be encountered near radiators, etc., as the plastic rod may deform under these temperatures.
- 6.04 The instrument should be CARRIED DOWN OR LOWERED from poles, NOT DROPPED, as the impact may short-circuit the elements in the neon glow unit of the indicator.

## STATION PROTECTION AND GROUNDING

CONTENTS	PAGE
1. GENERAL . . . . .	105
2. DESCRIPTION OF STATION PROTECTORS . . . . .	106
3. DESCRIPTION OF PROTECTOR MOUNTINGS AND ASSOCIATED EQUIPMENT . . . . .	108
4. INSTALLATION OF STATION PROTECTORS . . . . .	111
5. GROUNDING OF STATION PROTECTORS . . . . .	117
6. CABLE PROTECTION . . . . .	127
7. STATION PROTECTION REQUIREMENTS (AERIAL OR BLOCK CABLE) . . . . .	128
8. STATIONS REQUIRING SPECIAL PROTECTIVE MEASURES . . . . .	130
9. MAINTENANCE OF STATION PROTECTORS . . . . .	132

required at all stations served by open or multiple line wire and at stations served by exposed cable.



*Service orders or other local instructions will specify whether or not station protection is required.*

**IMPROPER GROUNDING AND BONDING  
 MAY RESULT IN:**

- Personnel Injury
- Damage to Premises and Equipment.

**1. GENERAL**

**1.01** This section contains general information pertaining to station protection, identification, installation and maintenance of protectors. It is reissued to update information.

**1.02** Station protectors prevent damage to station equipment from abnormally high voltages or currents. (Fig. 27) Station protection is



*On all station visits, inspect ground wire, ground clamp, and ground tag. Change ground connection to use the best grounding medium present. Report any sub-standard conditions to supervision for later correction. If the best medium available is a ground rod, make sure that the telephone rod is bonded to the power and lightning ground rods if available.*

*The telephone protector ground and the electrical service ground shall be interconnected.*

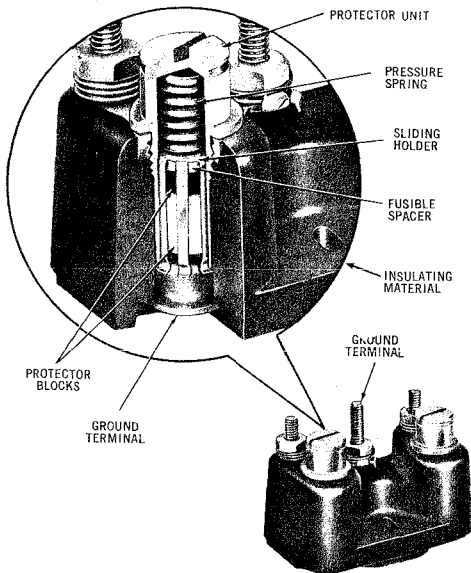


Fig. 1 — 123-Type Protector

## 2. DESCRIPTION OF STATION PROTECTORS

### 2.01 The 123A1A-Type Fuseless Protector

(Fig. 1) employs a sliding holder arrangement (2B1A protector unit), which encloses one No. 32A and one No. 33B protector block and a low-melting alloy spacer. This assembly and a pressure spring are located inside the brass cap and, when operated, provide a high-current capacity, low-resistance contact between cap and ground terminal. The flexible fingers of the holder make contact with the ground terminal in the base which prevents the heavy fault currents from flowing through and damaging the contact pressure spring. This protector is recommended as first choice, where applicable, because of its high fault current capacity. It should be used on open or multiple line wire only when the proper grounding electrode is available. The later model of the 123-A1A protector has slotted mounting holes oriented 90 degrees to each other to facilitate the mounting and aligning of protector when the anchor holes are not perfectly centered.

TABLE A

### PROTECTORS — FUSELESS AND FUSED

TYPE	PROTECTOR	USE	
		INDOOR	OUTDOOR
Fuseless	123A1A	x	(SEE NOTE)
	QPL3A		x
	116C 117B	x	x
Fused	98A	x	
	1093C		x

*Note:* For outdoor installation, a 150A cover is required.

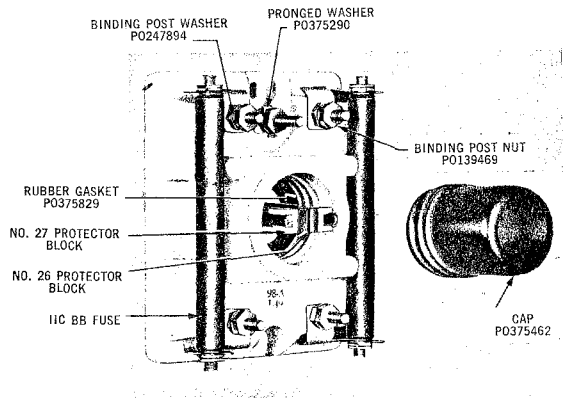


Fig. 2 — 98A Protector

**2.02 98A Fused Protector** (Fig. 2) consists essentially of a base of insulating material equipped with two No. 11CBB fuses and two each No. 26 and 27 protector blocks. The 98A Fused Protector is used only when conditions described in Paras. 7.02, 7.03 and 7.06 cannot be met.

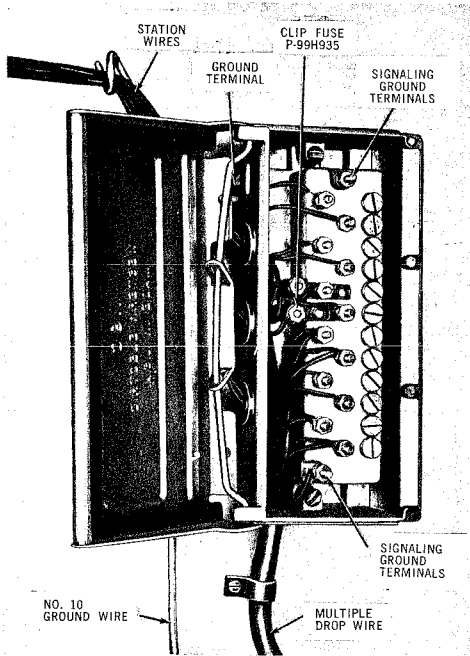


Fig. 3 - 116C Protector (Outdoor)

2.03 *116C Fuseless Protector* (Fig. 3) is arranged for fastening to mounting surface without requiring a separate mounting bracket. The signaling ground terminals are located at each end of the terminal block. It is equipped with 2A1A-3 mil. protector units.

2.04 *116D* is the same as the 116C Protector but is equipped with 2A1B-6 Mil. Protector Units.

2.05 *117B Fuseless Protector*, (Fig. 4) signaling ground terminals are located at each end of the terminal block. One of these terminals is arranged to permit installation of a No. 10 gauge wire for protector grounding purposes.

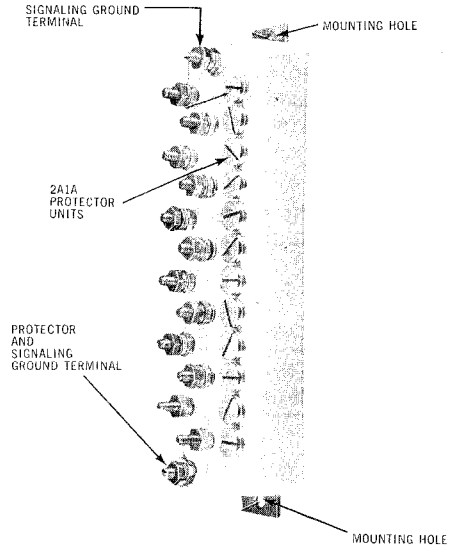


Fig. 4 - 117B Protector (Indoor)

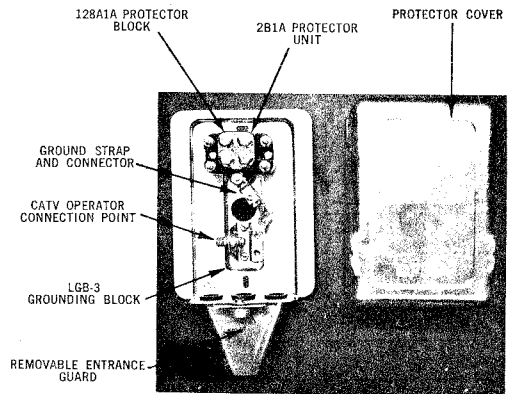


Fig. 5 - Protector QPL3A

2.06 *The QPL3A Protector* is an outside wall mounted protector (Fig. 5) consisting of a 128A1A-2 Two Station Protector and a coaxial

SECTION 460-100-400CA

LGB No. 3 Ground Block housed in a weatherproof metal box. It is intended for use with buried plant to provide test and ground connection points. This protector is equipped with four 2B1A Protector Units. For coaxial service wires when called for on engineering plans.

3. DESCRIPTION OF PROTECTOR MOUNTINGS AND ASSOCIATED EQUIPMENT

TABLE B  
PROTECTOR CAPACITY OF BACKBOARDS

Type of Protector Installation	Backboard Type
123A1A — Single	171
123A1A — (2 or 3)	79

3.01 *Backboards* should be used only when required, for example, on uneven or insecure mounting surfaces. Choose backboard as indicated in Table B or a suitable alternate type.

TABLE C  
GROUND WIRE CAPACITY, CLAMP TYPE

GROUND WIRE SIZE	NO. OF PROTECTED CIRCUITS		CLAMP
	FUSELESS	FUSED	
No. 14	1	3	Station Ground Clamp
No. 12	2	6	
No. 10	6	7	
No. 6	7 or More	8 or More	2B
No. 0			3B

*Note:* The ground wire between protectors shall be the same size as the ground wire between the protector and the grounding electrode.

TABLE D  
CONNECTORS

WIRE SIZE	TYPE	USE
No. 6 to 8 Solid or Stranded	22031	Bridging
No. 3 - Stranded No. 2 - Solid	22031	Bridging
3/16" Max. Opening	35301F	Terminating
5/16" Max. Opening	35401F	Terminating
24 - 26 Gauge	B Wire Connector	Bridging

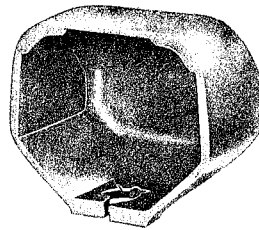
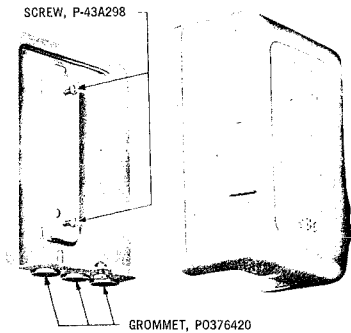


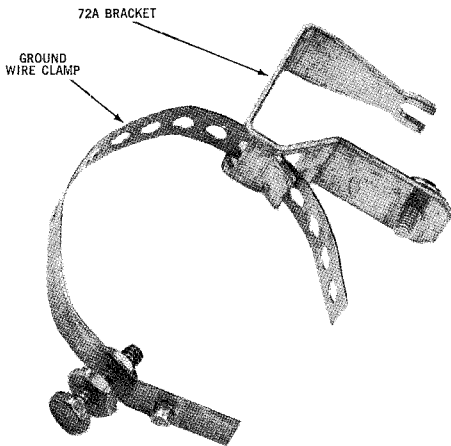
Fig. 6 — 150A Cover

3.02 *150A Cover* (Fig. 6) is used as a protective covering for the 123 type protector when mounted outdoors or in a dusty location. When this cover is used, the protector is mounted directly on the mounting surface. There is no code assigned to the combination of a protector and the 150A cover.



**3.03 93C Protector Mounting** (Fig. 7) consists of a metal base and removable metal cover. It is intended to house the 98-type protector for outdoor installation and is furnished with two screws for fastening protector to base. When equipped with a 98-type protector it is coded 1093C.

**Fig. 7 — 93C Protector Mounting**



**3.04** The **72A Bracket** (Fig. 8) is used to mount a 123A1A protector on an acceptable metallic cold water pipe or to a power stack by means of a station ground clamp (Figs. 13 and 14).

**Fig. 8 — Station Ground Wire Clamp Through Slot in 72A Bracket**



SECTION 460-100-400CA

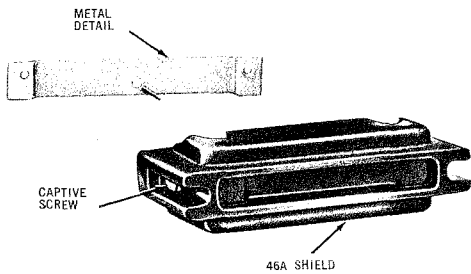


Fig. 9 - 46A Shield

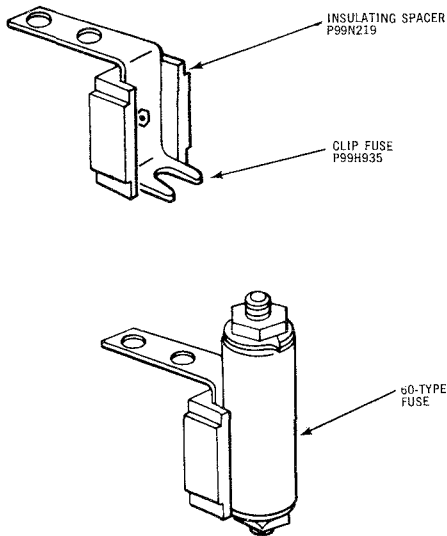


Fig. 10 - 60 Type Fuse, Fuse Clip and Spacer

3.05 The *46A Shield* (Fig. 9) consists of a shield of insulating material containing two captive screws and a metal mounting strap.

3.06 The 46A Shield is used with the 98A Protector when mounted in commercial boxes. When the fuses blow, the shield prevents hot gases from short-circuiting or grounding the terminals of the protector.

TABLE E  
60-TYPE FUSES

Fuses	Current (Amperes)		Colour of Shell
	For 3 Hrs.	For Less Than 210 Sec.	
60A	.350	.500	Red
60D	.350	.500	Red
60E	1.25	1.800	Black
60G	.500	.750	Grey

3.07 *Sneak Current Fuses (60-type)* (Fig.10) are required when specified on the service order or by other local instructions.

3.08 When sneak current (60-type fuses) protection is required for pairs terminated on 116- or 117-type protectors, and 5555 Connecting Blocks use Insulating Spacer P99N219 and Fuse Clip P99H935, see Table E for type of fuse required.

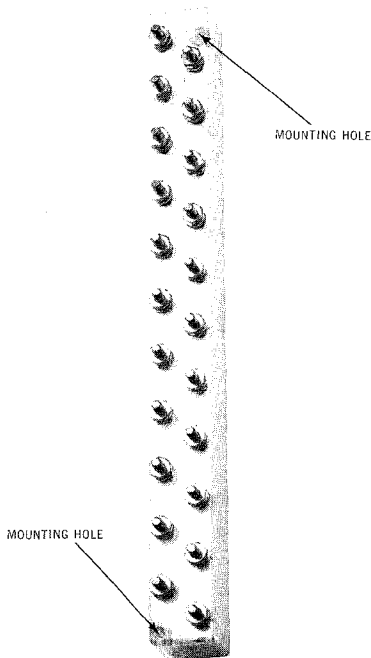


Fig. 11 — Connecting Block 5555

3.09 The *Connecting Block 5555* (Fig. 11) is an eleven pair terminal connecting block. The mounting holes are at the top right corner and the bottom left corner. It is used to mount 60 type fuses where several circuits require sneak fuse protection.

4. INSTALLATION OF STATION PROTECTORS

General

4.01 Consider the following when locating protectors:

- Accessibility (avoid placing where a ladder is necessary for installation or maintenance).

- Location of telephone, protector ground, and entrance for drop or block wire.
- Appearance (avoid locations on fronts of buildings or in living quarters).
- Dry and well-ventilated locations when mounted inside or underneath buildings.
- A caution tag, Form 1622 may be placed at each protector to warn workmen against disturbing, concealing or removing the equipment.

4.02 The protector shall be located in or on the building, as near as practicable to the point where the conductors enter.



*Special protection arrangements for station sets located in explosive atmospheres or autotrailers are included in the section covering such installation.*

**WARNING:** Where services are to be installed in power stations, information should be obtained through your supervisor from the engineering department.

TABLE F  
FASTENERS FOR MOUNTING

Apparatus	Fasteners
Protectors	No. 8 RH wood screws, or equivalent
Protector Mountings	No. 8 RH galvanized wood screws, or equivalent
116C Protector	No. 14 RH galvanized wood screws, or equivalent
117B Protector	No. 10 RH wood screws, or equivalent
5555 Connecting Block	No. 8 RH wood screws

## Fastening Protectors and Mountings

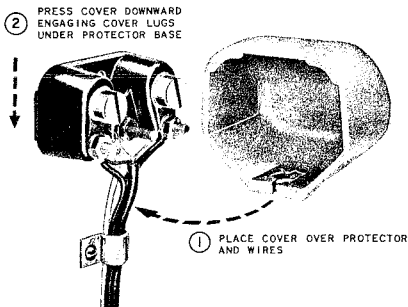
**4.03** 123A1A protectors may be mounted securely in any position except when using a 72A bracket on a pipe where there is a possibility of condensation. In this case do not mount the protector on the underside of the pipe.

**4.04** Except when mounted on a horizontal surface the 1093C protector should not be mounted with fuses parallel to the ground.

**4.05** Fasteners are indicated in Table F. All screws and fasteners shall be of sufficient length to *mount securely*.

## Installing 123 Type Protectors

**4.06** Terminate line and inside wires on protectors so that the ring conductors (single-tracer or red wires) shall be connected to the right side of the protector (on ceilings, the right side as viewed from the inside wiring end of the protector).



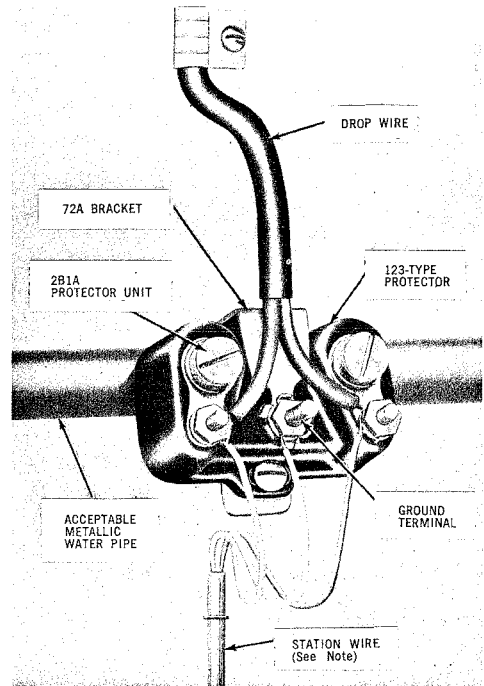
**Fig. 12 — Installation of 123A1A Protector with 150A Cover**

**4.07** When using a 150A Cover, it is recommended that all wires be brought together under a common clamp as a last attachment located approximately 2 inches below the protector (Fig. 12). Because of the size of the snap-on cover, it is also recommended that the finished lengths of insulated conductors from the outer jacket be somewhat less than that which is normally allowed.

**4.08** To remove the 150A Cover from a mounted protector, grasp the sides of the cover with the thumb and forefinger and at the same time apply pressure with the middle finger at the central tapered portion in an upward direction. When the cover lugs clear the base of protector, the cover may be lifted off.

**4.09** Installation of the 123 Type Protector and 150A Cover is shown in Fig. 12.

**4.10** When it is necessary to multiple fuseless or fused protectors, there should be 1 inch separation when horizontally mounted and 2 inches separation when vertically mounted.



**Fig. 13 — 123 Type Protector Installed With 72A Bracket**

**4.11** Place ground wire clamp through slots in 72A Bracket shown in Fig. 8 and attach ground wire clamp to pipe in usual manner. Remove screw from 72A Bracket and slide protector

into place, making sure the notched portion of the clamp is under the pronged washer of the protector ground terminal. Place screw through mounting hole in protector and into threaded hole in the bracket. Tighten mounting screw and protector ground terminal nut thoroughly. A protector mounted in this manner is grounded through the 72A Bracket and eliminates the use of station ground wire. (See Fig. 13.)

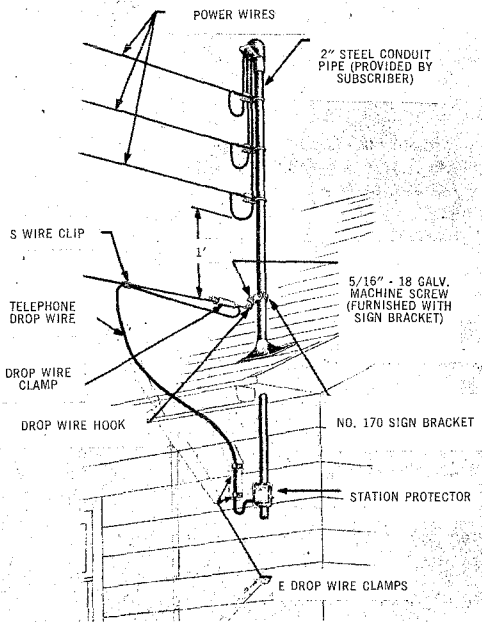


Fig. 14 — 123 Type Protector Installed on Power Stack With 72A Bracket

#### Precautions To Be Taken When Attaching Protector To Power Stack

- 4.12 Attachment to the power stack can *only* be used in areas with a multi-ground electrical system, *only* when this type of system has been identified by immediate supervision.
- 4.13 The power stack must be tested with the Z Voltage Tester before proceeding with work operations.
- 4.14 Remove paint and oxidization from power stack in the immediate area of the protector to ensure a good ground.
- 4.15 Observe location of the power service drops in order to avoid body contact. Wear insulating gloves and "Z" Protective Cap when making attachment to the fixture. Obtain a separation of at least one foot between telephone and power wires.
- 4.16 Using a 72A Bracket and a Station Ground Wire Clamp, install the protector in the manner described in Para. 4.11 of this practice. Place a 150A Cover over the protector and wires. This method of installation will result in the protector being mounted 90° from the normal position. Place a drip loop in the drop wire to prevent water running into the protector. Locate the protector on the power stack as close as possible to the point of entry into the building to reduce the amount of exposed station wire. (See Fig. 14.)

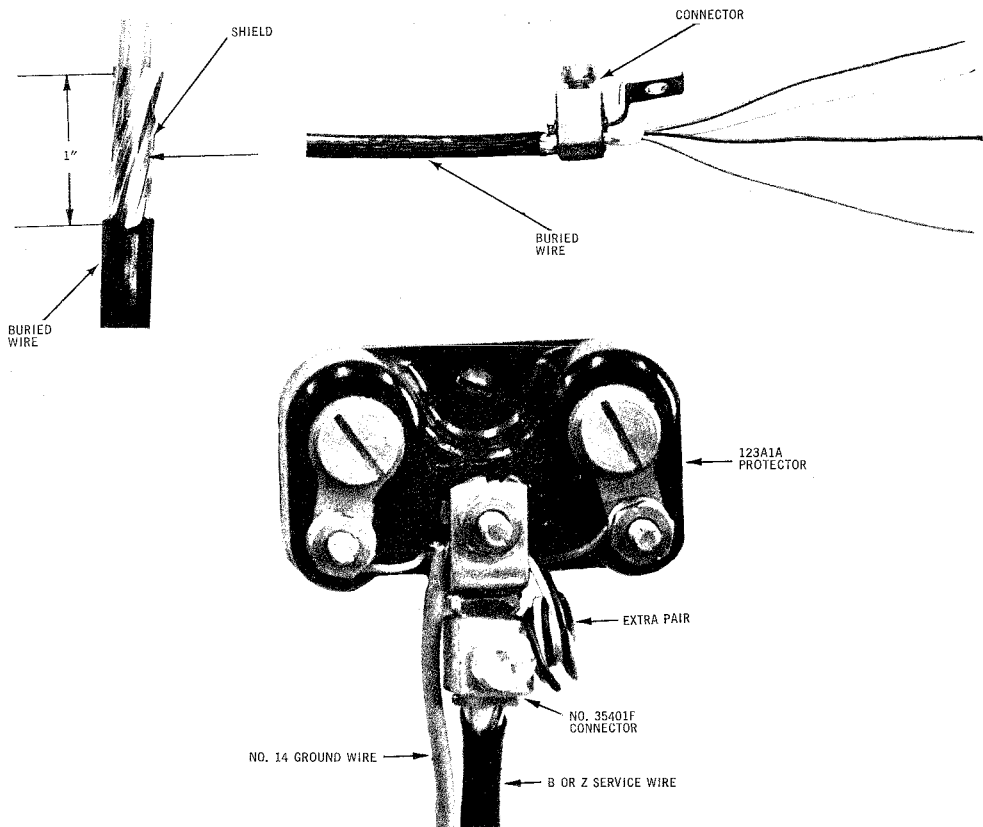


Fig. 15 — Buried Installation With 123 Type Protectors

**Buried Wire Installation**

4.17 The shield of the buried wire shall be grounded at the distribution terminal and at the subscriber's premises in all instances. The placing forces shall make the initial ground connections, at both the distribution terminal and at the subscriber's premises, at the time the wire is placed.

4.18 Install the 123 type Protector and mark the location of the 35401F Connector. Leave a minimum of 6 inches of wire beyond this location.

4.19 Cut off the exposed armour on B or Z Service wire to a point 1 inch from the outer jacket. (Fig. 15) Remove the inner jacket leaving about 1/8 inch beyond the end of the armour.

4.20 Insert the wire into the 35401F Connector centering the armour in the barrel. Tighten the bolt with a screwdriver. (See Fig. 15).

4.21 Place the pronged washer on the ground lug between the ground wire and the connector. Place the brass washers and nut on top of the connector and tighten the nut with the 216B or equivalent tool. (See Fig. 15).

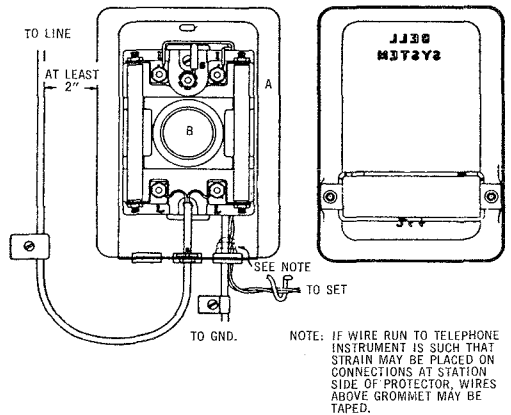
#### Installation Of The QPL3A Protector

- 4.22** The QPL3A Protector should be located directly over the entrance trench and attached to the outside wall of the subscriber's house at a height of 3 to 5 feet above ground level.
- 4.23** Terminate the service wires on the connecting block as indicated in this section. Ground the armoured shield to the ground lug of the protector.
- 4.24** A number 10 Ground Wire must be connected from the ground lug of the QPL3A to an appropriate ground.
- 4.25** Connect the CATV Service Wire to the LGB3 Grounding Block as indicated in Section 462-405-205 of Bell Canada Practices.

#### Installation Of The 116 And 117 Protectors

- 4.26** The 116C Protector (Fig. 3) is served by a multiple drop wire, but can also be served by separate drop or block wires. All drop and block wire conductors must be terminated during the initial installation. Place the individual wires under the bottom nut of each binding post. Station wires should be terminated between the washers below the top nut. A ground terminal is provided on the rear of the protector and the signaling ground posts are internally bonded to it.
- 4.27** The 117B Protector is wired the same as the 116C Protector, except for the ground connection. The ground wire on the 117B is placed

underneath the pronged washer on one of the ground posts (Fig. 4). A No. 10 ground wire should be used to ground the 116C, or 117B Protector.



- A—11C-BB Fuses (must have centre slots).  
Turn slots so that they face the base.
- B—Cap (PO375462).

Fig. 16 — Installation of 1093C Protector

- 4.28** The 1093C Protector consists of a 98A Protector mounted in 93C Protector Mounting. Installed as shown in Fig. 16.

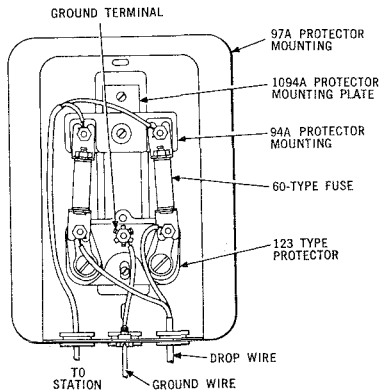


Fig. 17 — Fuseless Protector and 60-Type Fuses

**Sneak Current Fuse Installation**

4.29 Sneak current fuses (60 type) are not required with protectors associated with residence systems, wiring plans, or key equipment. They shall, however, be provided on special service and leased lines when specified on the service order or by other local instruction.

4.30 Where sneak current fuses are required a 94A Protector in a 97A Protector Mounting is used and connected between the protector and the station.

4.31 60 type fuses and 94A Protector Mountings must be mounted on an incombustible surface. Use 97A Protector Mounting (Fig. 17) if surface is combustible.

4.32 The 94A Protector Mounting consists of a porcelain base equipped with clips for mounting two No. 60-type fuses (sneak current fuses). When specified, they may be mounted with 123A1A protectors. Two 60-type fuses are placed between the protector and 94A protector mounting. Mount 123A1A Protector with code inverted (Fig. 17).

4.33 When sneak current (60-type fuses) protection is required for pairs terminated on 116- or 117-type protectors. PO99H935 fuse clips and Insulating Spacer P99N219 are required.

4.34 When sneak fuses (60 type) are required with a 98A Protector, the 94A Protector Mounting is installed directly above the 98A Protector. The 60 type fuses with fuse clips are used to interconnect the protector and the mounting together. The station is connected to the 94A mounting side of this arrangement.

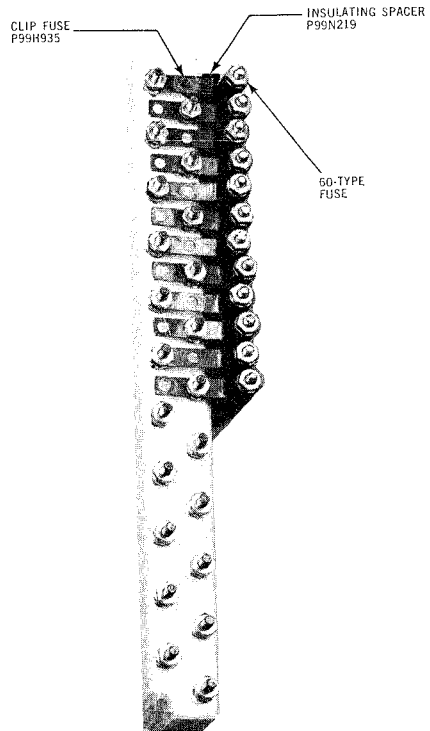


Fig. 18 — Connecting Block 5555 Equipped With 60-Type Fuses, Clip Fuse P99H935 and Insulating Spacer P99N219

4.35 The Connecting Block 5555 should be installed where several circuits require sneak fuse protection. Equip this connecting block with 60 type fuses, Clip Fuse P99H935 and Insulating Spacer P99N219 as shown. This connecting block should be used only where additional protection is required for sneak currents and the normal protector block operation has been provided. (Fig. 18)

## 5. GROUNDING OF STATION PROTECTORS

**5.01** On visits to previously installed stations, inspect the grounding system. Systems not properly grounded must be changed to meet the current grounding and bonding requirements.



*The telephone protector ground and the electrical service ground shall be interconnected.*

**5.02** When available, a public metallic water pipe provides the preferred grounding medium. A private metallic water system with at least 10 feet of buried metallic pipe is an acceptable grounding medium and is preferred to a ground rod. Connect the ground wire to the metallic *cold water pipe* at a point where normal maintenance of water meters, pumps, or the installation of insulating sections for reducing vibrations will not interrupt the circuit to ground or common bonding to power ground. The telephone protector ground must be located on premises.

**5.03** When the interior metallic cold water pipe is insulated from the buried water system by an insulating joint or when the water system is nonmetallic, the interior metallic water piping is not an acceptable ground and an alternate method (Para. 5.15) must be employed. The alternate selected ground shall always be bonded to the interior metallic cold water piping system which would then be an acceptable protector ground.

**5.04** When an insulating joint, pump or water meter separates the interior system from an acceptable water system a bond using No. 6 ground wire must be placed to provide continuity between the two systems. The interior system would then be an acceptable protector ground.

**5.05** The term "Multigrounded Neutral Power System" means a power system where the neutral of the transformer is grounded, and where the neutral conductor strung along with the phase conductors is grounded at frequent intervals (at least four ground connections in each mile of line). This term is abbreviated as MGN.

**5.06** The MGN (multigrounded neutral) type power system is an acceptable ground but it is not in general use in all areas. A power company may have adopted the MGN as its policy on new or rearranged construction and still have a portion of its plant operating without a multigrounded neutral. To properly interpret this section, it is necessary to know in any given situation whether the power system is MGN. This information shall be obtained through supervisory channels.

**5.07** Whenever possible, use a 72A Bracket to ground a fuseless protector. If a ground wire is necessary, the run should be short, straight, and if possible a continuous piece of wire, (Fig. 19).

### Precautions

**5.08** *Before connecting the protector ground wire, test the power company ground rod, ground wire, cabinet, meter box, etc, with a Z Voltage Tester as prescribed in Section 620-105-010 of the Bell System Practices.* The voltage test shall be as prescribed for vertical power ground wires or metallic conduit. If the grounding mediums are energized, proceed no further with the work. Report this condition to the proper supervision so that the power company or customer owned power system may be informed of the situation.

**5.09** Do not attach ground wires to the interior of any service entrance box, fuse box, meter box, etc.

**5.10** Due to corrosive action, do not attach ground wire to power service aluminum ground wire, aluminum conduit, aluminum service boxes, etc.

**5.11** Do not attach ground wire to gas pipes.

**5.12** Stations located at power company stations, or in explosive atmosphere, or connected to foreign communication circuits usually require special protection. These installations are covered in other sections of the Bell System Practices.

**5.13** At radio or television stations connect the protector ground to the radio or television station ground.



**TABLE G**  
**PROTECTOR GROUNDING**

A1 — MGN System on acceptable metallic water pipe A2 — MGN System on ground rod B1 — Non-MGN System on acceptable metallic water pipe B2 — Non-MGN System on ground rod C — Power not grounded at premises D — No power			
WATER PIPE	POWER CONDITION	WHAT TO DO FOR PROPER PROTECTOR GROUNDING	FIG.
Acceptable metallic water pipe (at least 10 feet in moist soil)	A1 or B1	Ground protector preferably to metallic water pipe. Second choice to power service conduit or third choice power service ground wire.	24
	A2 or B2	Ground protector to metallic water pipe and bond power ground rod to water pipe	25
	C or D	Ground protector to metallic water pipe (if C, refer to Para. 5.18)	26
Metallic interior water piping not acceptable because of plastic entrance, insulating joints, etc.  <b>Note:</b> If the insulating joint has been bypassed by a No. 6 ground wire or if the interior water system has been bonded to the power ground the interior system would be considered an acceptable protector ground.	A2	Ground protector to MGN ground rod. Bond with No. 6 station ground wire to metallic water pipe. If ground rod not accessible ground to power service conduit or ground wire	28 or 29
	B2	Ground protector to best available ground or telephone ground rod. Bond to power ground rod and interior metallic water pipe with No. 6 station ground wire. If power ground rod is not accessible bond to power service conduit or ground wire.	30 or 32
	C or D	Ground protector to best available ground or ground rod, bond to interior metallic water pipe using same size station ground wire as protector ground wire (if C, refer to Para. 5.18)	33
No metallic water pipe or not possible to connect to metallic water pipe	A1 or B1	Ground Protector to power service conduit or power service ground wire.	35
	A2	Ground protector to MGN power ground rod, or, if ground rod is not accessible, ground protector to power service conduit or ground wire.	34 or 35
	B2	Ground protector to telephone ground rod and bond with No. 6 station ground wire to power ground rod.	36
	C or D	Ground protector to best available ground (if C, refer to 5.18)	39

**Note:** Verify existing power and telephone bonding and grounding. If they meet these requirements no further action is required.

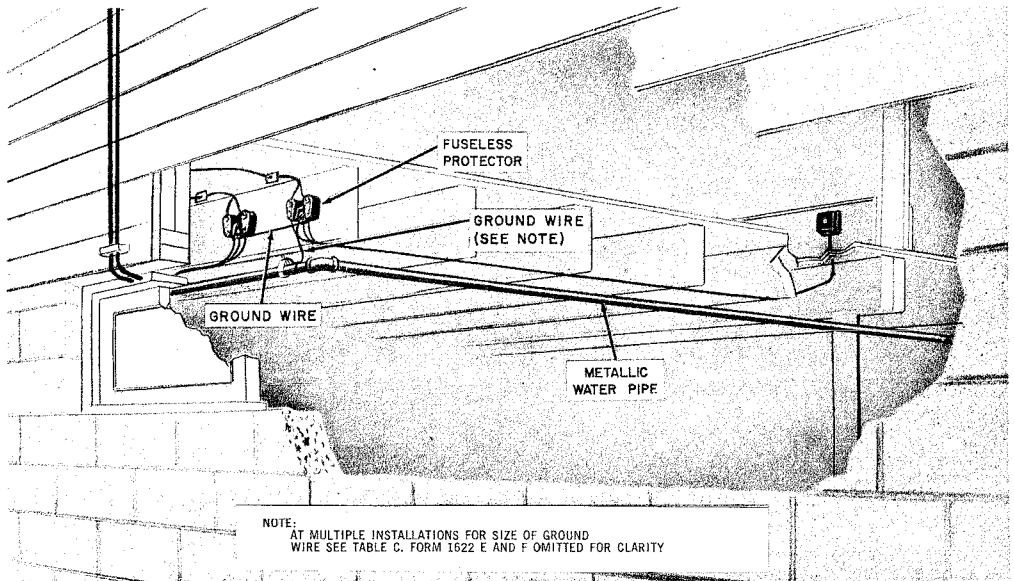


Fig. 19 — Ground Wire Run-Fuseless Protector

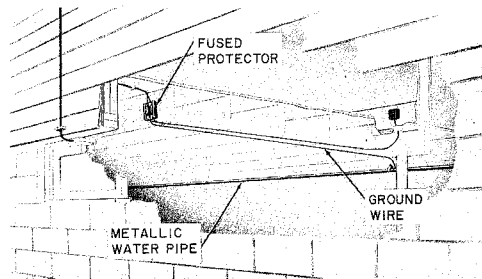


Fig. 20 — Ground Wire Run-Fused Protector

#### Installation of Station Ground Clamps

5.14 The ground clamp (Fig. 21) should be located at an accessible point where it will not be subject to excessive movement or vibration and where it will least likely be damaged by plum-

bers or other workmen. If the pipe is insecure or subject to vibrations, tape the ground wire to the pipe in close proximity to the ground clamp. (Fig. 22).

5.15 Where insulating joints are found (usually at meters, pumps, valves, etc.), the ground clamp should be installed at a point where the insulating joint will not break continuity to ground. Where pumps, meters, etc. may be removed for seasonal overhaul, the ground clamp should be installed at a point where the continuity to ground will not be broken. However, after placing No. 6 bond wire which would not have to be removed during servicing, the interior system would provide a suitable protector ground.

5.16 Make certain that the surface of the metallic pipe to which the ground clamp is being fastened is free of paint, rust, etc.

5.17 Form 1622E or 1622E and F (Fig. 23) should be placed at all ground wire terminations to warn people not to disturb the clamp or wire.

SECTION 460-100-400CA

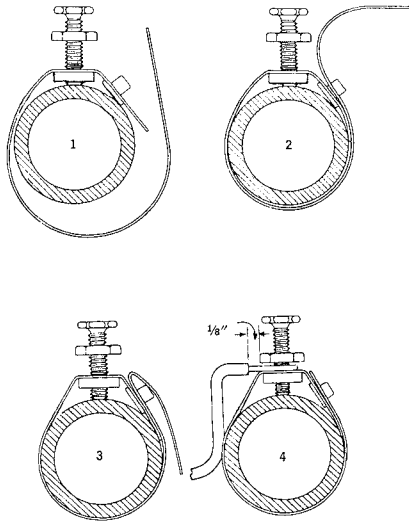


Fig. 21 — Station Ground Clamp Installation

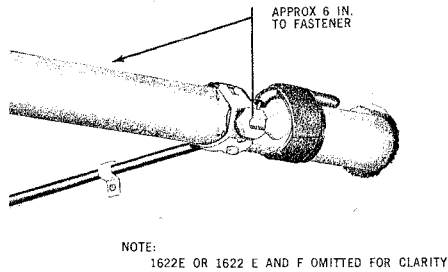


Fig. 22 — Typical Ground Clamp Installation

TABLE H  
GROUND WIRE SIZES

PROTECTOR		GROUND WIRE SIZE
TYPE	NUMBER	
98A	3	No. 14
123A1A	1	No. 14
123A1A	2	No. 12
116C or 117B	1	No. 10
QPL3A	1	No. 10

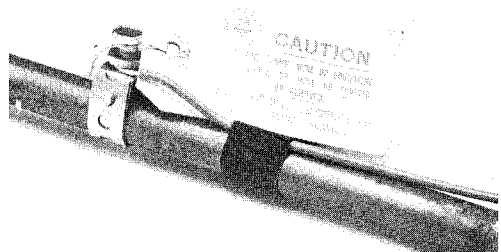
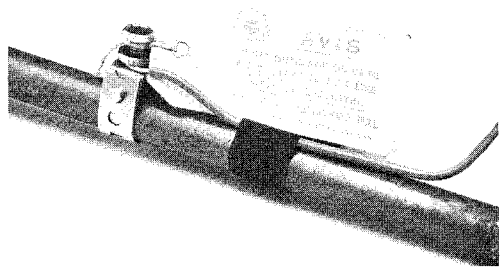


Fig. 23 — Tag 1622E and F Attached to Station Ground Clamp

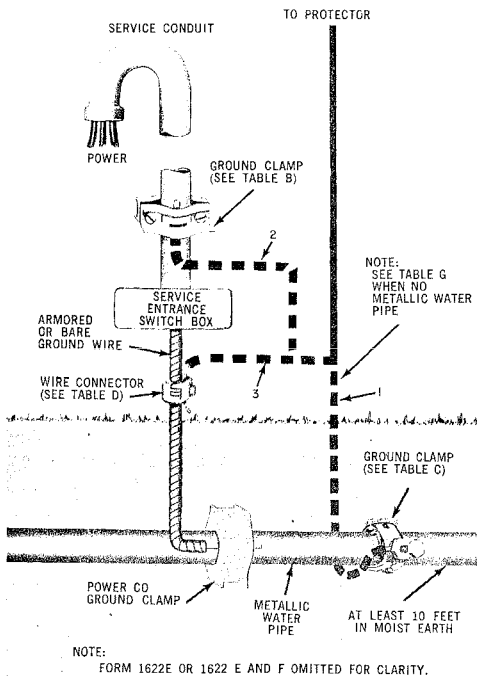


Fig. 24 — Power Grounded to Acceptable Water System

#### Bonding of Power and Telephone Grounds

5.18 When a situation exists where the power and telephone grounds are not common, the following corrective arrangements should be made:

- (a) If an acceptable public or private water system is available and the power service is grounded to a ground rod, connect the telephone protector to the metallic water system. In addition, a No. 6 station ground wire should be bonded to the interior metallic water pipe and the power ground rod. (Fig. 30)
- (b) If the power service and the telephone protector are connected to separate ground

rods, bond the two rods together as shown in Fig. 36.

- (c) If lightning ground rod present, it must be bonded to telephone ground rod. (See Fig. 31).

5.19 The customer's telephone service may be installed where a power ground is not provided. However, the customer should be informed immediately of the need for a power ground and should be requested to notify the telephone company when the ground has been provided. *The procedure for notifying the customer shall be covered by local instructions.* Where telephone service is already being furnished and there is no power ground, the same procedure should be followed. When installing telephones at contractor shacks, trailers, etc. and an acceptable metallic cold water pipe is not available, the telephone protector must be connected to a telephone ground rod. This ground rod must be bonded to a power ground rod as soon as the power ground rod has been installed and connected.

5.20 Where there is a television mast ground, and there is no common grounding of the mast, power and telephone services on a metallic water pipe system, advise the customer of the desirability of interconnecting this ground and others on the premises.

#### Selection of Signal Ground

5.21 When signal ground is required the protector ground should be used as first choice. Ground strips connected to ground sheath cables are suitable for signaling grounds.

5.22 When commercial power is connected to telephone apparatus the signaling ground shall be bonded to the protector ground at the protector or by using the same grounding medium. When commercial power is not connected to telephone apparatus it is desirable to bond protector and signaling ground; however, it is not required.

## Locating And Installing Ground Rods

**5.23** *Precautions to be taken when installing ground rod.*

1. Avoid personal injury by protecting eyes and hands when installing ground rod.
2. Due to the increasing use of buried power cables, it is essential that the following precautions be observed:
  - (a) During the installation of a ground rod, insulating gloves must be worn.
  - (b) After installing the ground rod, and before connecting the ground wire to the rod, test the rod with the Z Voltage Tester to ensure that it is not energized.
  - (c) If a ground rod is found to be energized, proceed no further with this work. Place some protection to guard the public and notify supervision.

**5.24** Locate and install ground rods as follows:

- (a) Where least likely to be damaged or tampered with.
- (b) As near as practical to masonry walls in earth-floor basements.
- (c) Approximately 12 inches from outside wall.
- (d) Approximately 2 feet from base of wooden poles or posts where conditions permit.
- (e) At least 6 feet from power service, or lightning ground rod. (Fig. 30 and 31).
- (f) Do not unspiral the tail wire attached to the ground rod until the driving operation is complete.
- (g) Drive ground rods until the top of the rod is approximately 3 inches below ground level. Increase depth where damage from digging is likely.

**5.25** Inspect ground rods before and after driving to make certain that tail wires are not broken. If the tail wire is broken replace with another rod or use a ground clamp of the proper size as listed in Table C.

**5.26** After the ground rod is installed, No. 14 station ground wire is spliced to the tail wire with a 0.064 brass sleeve. Press the sleeve 6 times, 3 times each side of center. Do not tape splice. When a larger size of ground wire must be terminated on the ground rod, select the proper size and type of ground clamp as listed in Table C.

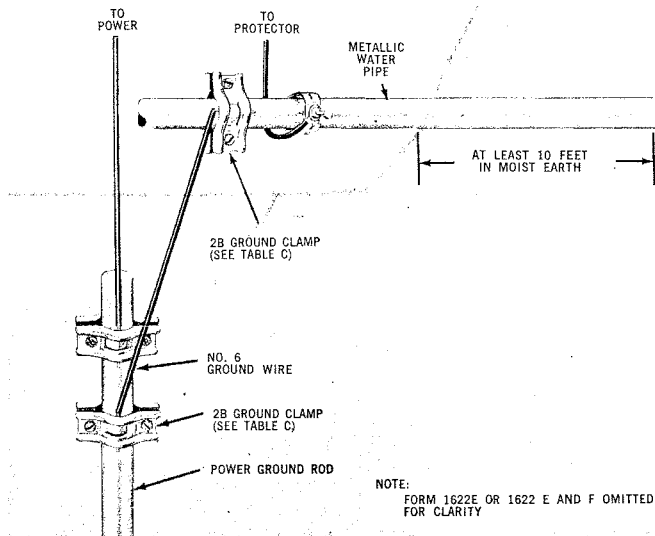
**5.27** When two or more protectors requiring ground rods are installed at the same location proceed as follows:

*Note:* Use the proper size station ground wire as listed in Table C.

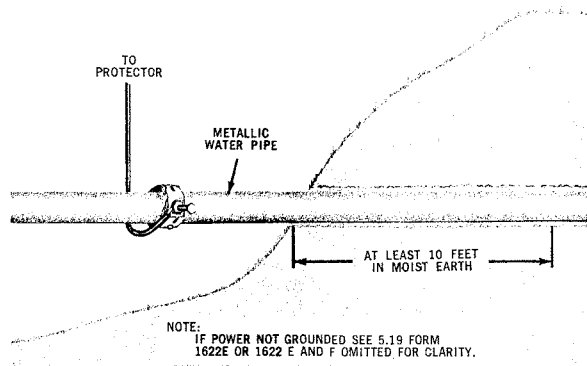
- (a) If a power ground rod is not available, install a ground rod for each protector. Bond all protectors together. No more than 3 ground rods spaced at least six feet apart need to be placed.
- (b) If a power ground rod is available, one telephone ground rod is sufficient. Bond all protectors together and bond telephone ground rod to power ground rod (Fig. 36).

**5.28** Multiple station protectors, such as the 116, or 117 type, may be connected to any of the grounds shown in Table G but should not be connected to a single telephone ground rod unless the rod is bonded to the power system ground rod. If a power ground rod is not available, a multiple station protector may be connected to an array of three telephone ground rods, spaced at least 6 feet apart and bonded together with No. 6 station ground wire.

**5.29** Where the telephone ground wire is near a walk or other thoroughfare and such a location cannot be avoided, protect the wire with  $\frac{1}{2}$  in. Half-Round Wood Moulding to a height of approximately 8 ft. above the ground.



**Fig. 25 — Grounding to Metallic Water System—Power on Ground Rod at Premises**



**Fig. 26 — Grounding to Metallic Water System—Power if Any Not Grounded at Premises**

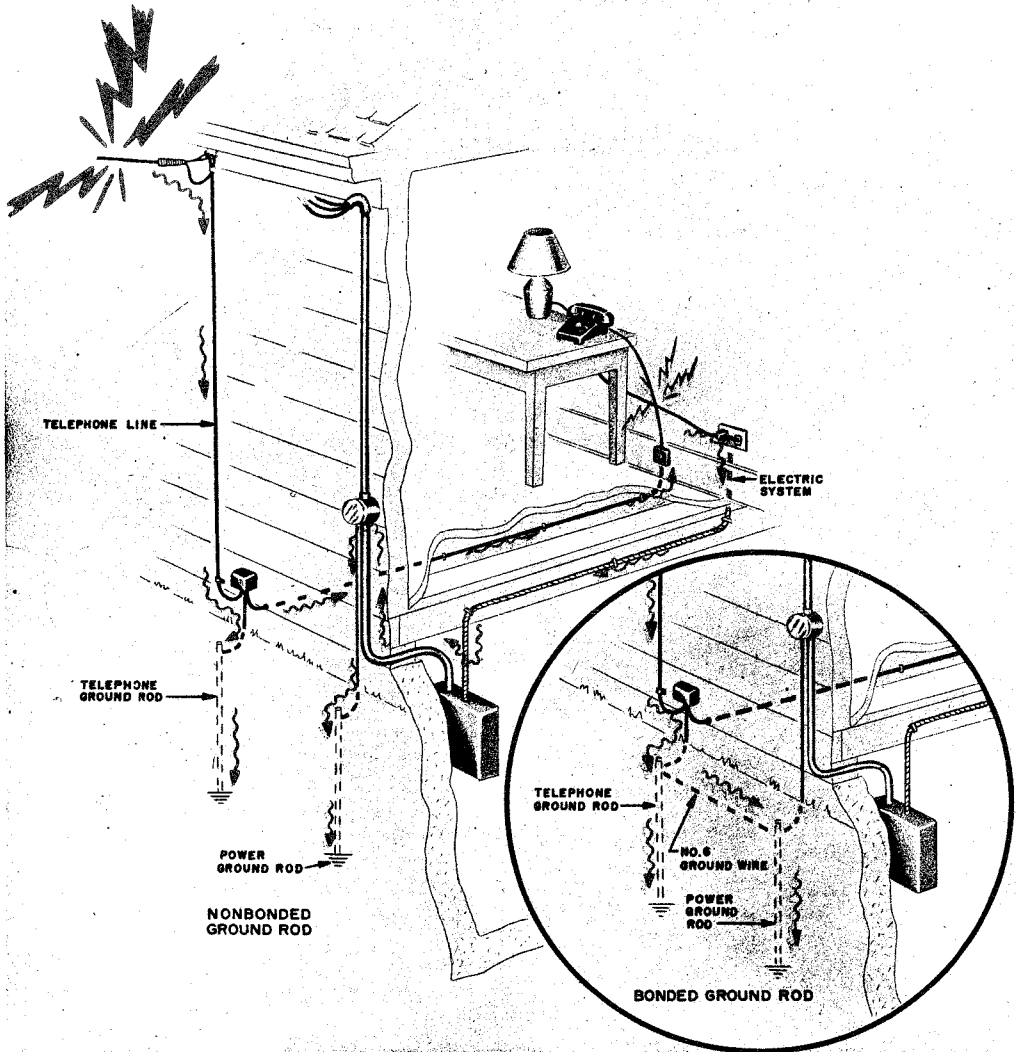


Fig. 27 — Effects of Bonding and Grounding

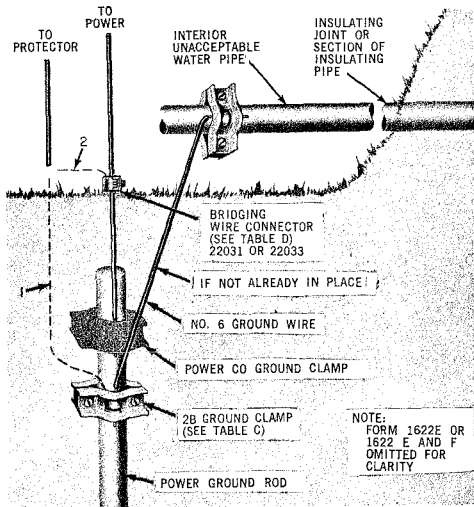


Fig. 28 — MGN Power Grounded to Ground Rod — Unacceptable Interior Water System

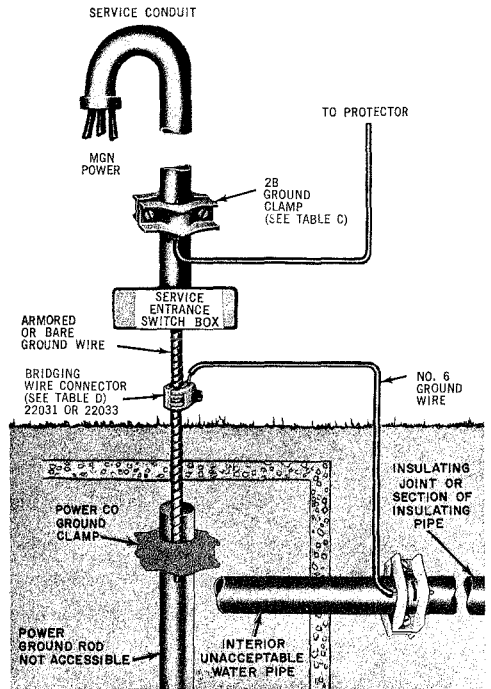


Fig. 29 — MGN Power Grounded to Inaccessible Ground Rod—Unacceptable Interior Water System



SECTION 460-100-400CA

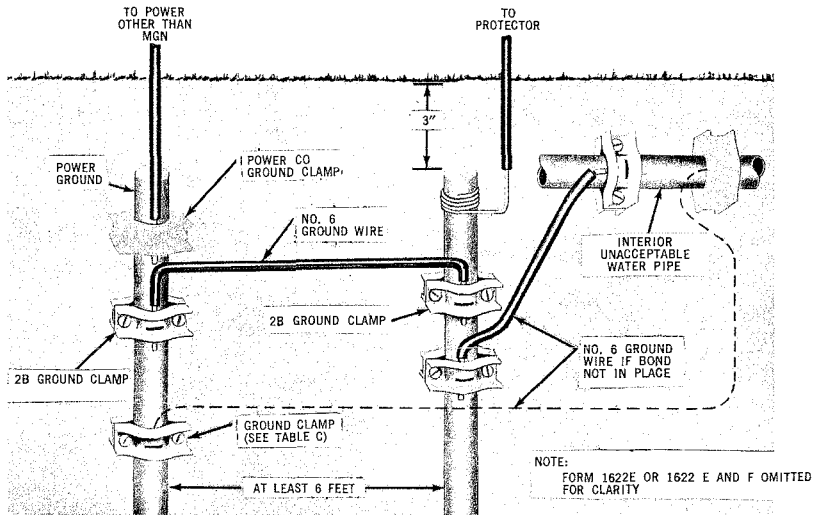


Fig. 30 – Power Other Than MGN Grounded to Grounded Rod Unacceptable Interior Water Pipe

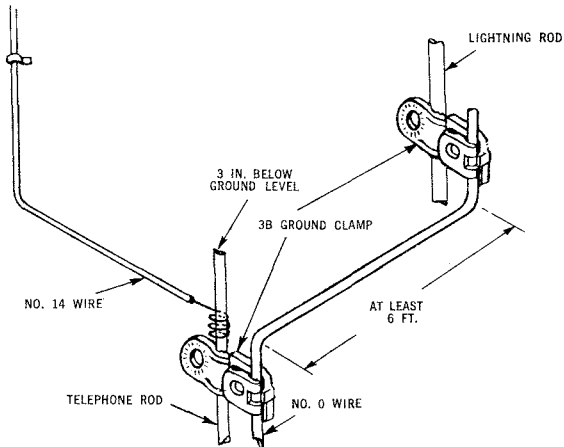


Fig. 31 – Bond to Lightning Rod

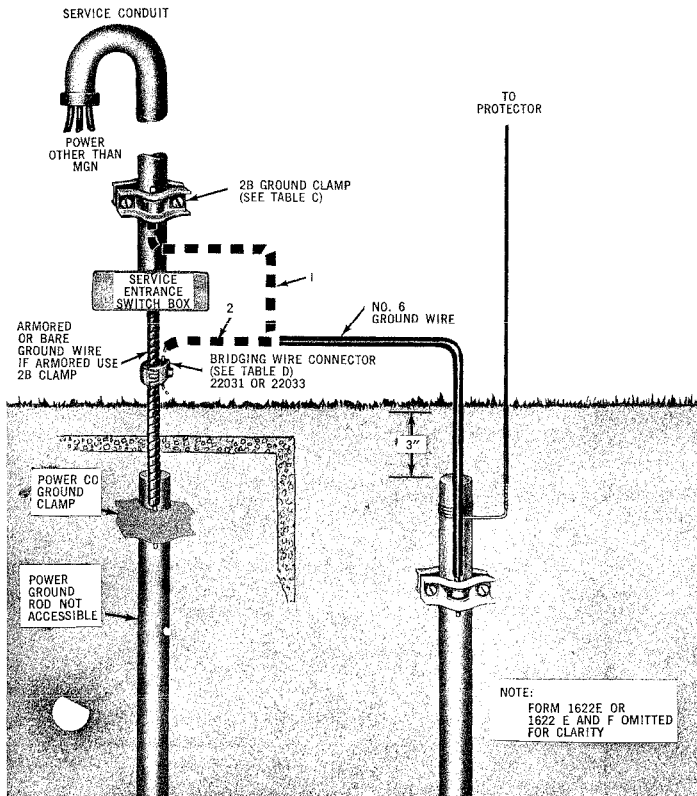


Fig. 32 — Power Other Than MGN Grounded to Inaccessible Ground Rod

## 6. CABLE PROTECTION

**6.01** Isolated sections of aerial cable are considered as open wire for the purpose of determining the type of protector required unless the cable is effectively grounded to a multigrounded neutral or to an extensive water (metallic pipe) system.

**6.02** Cable, wire, strand, etc., that is subject to disturbances by lightning or possible contact or induction from electric circuits in excess of 300 volts are called exposed cable, wire, or circuits.

**6.03** Cable, wire, strand, etc that are not subject to disturbances by lightning or electric circuits in excess of 300 volts are called unexposed cable, wire, or circuits.

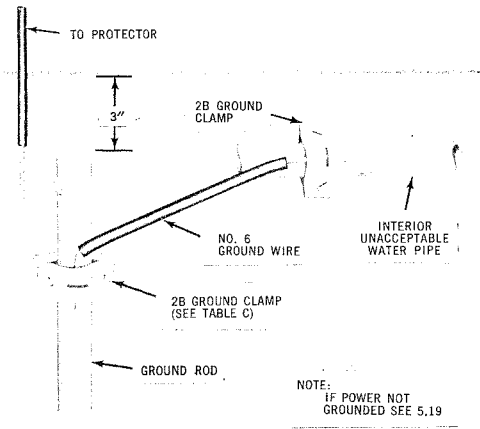


Fig. 33 — Power Not Grounded on Premises—Unacceptable Water Pipe

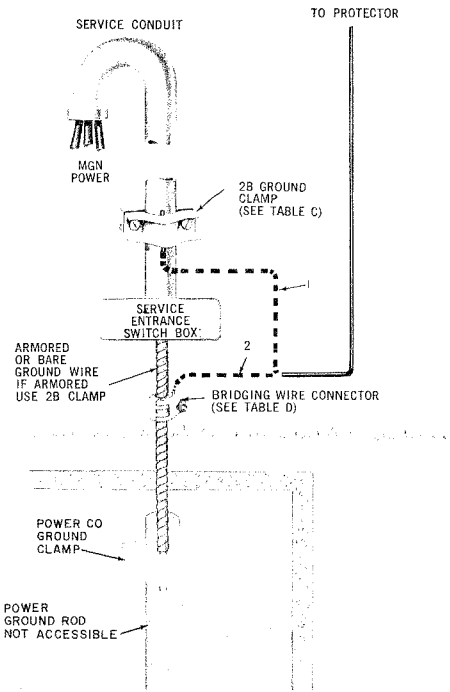


Fig. 35 — MGN Power Grounded to Inaccessible Ground Rod—No Water Pipe—Connection to Pipe Not Possible

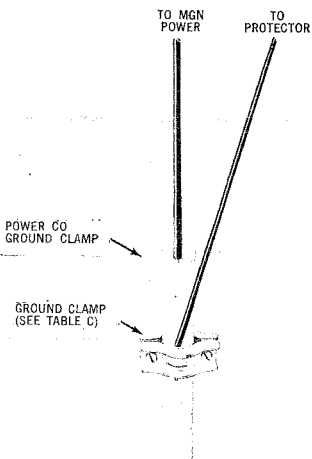
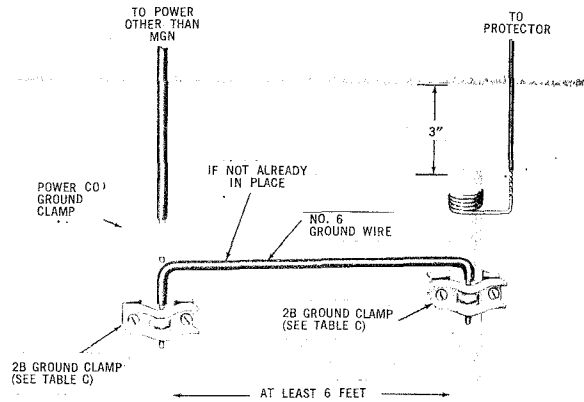


Fig. 34 — MGN Power Grounded to Ground Rod—No Water Pipe—Connection to Pipe Not Possible

7. STATION PROTECTION REQUIREMENTS  
(AERIAL OR BLOCK CABLE)

7.01 Fuseless station protectors should be used at all stations connected to a cable terminal served by a cable with a grounded metal sheath or shield, such as lead, alpth, stalpeth, etc. When a drop wire is to be joined *directly* to a cable pair a fusible link is required. (See Para. 7.03 for description of fusible link.)

7.02 The fuseless protectors should be installed when single pair drop wire is used at stations served by open or multiple wire when the protector can be grounded as follows:



**Fig. 36 — Power Other Than MGN Grounded to Ground Rod—No Water Pipe**

- (a) A metallic cold water pipe having at least 10 feet buried.
- (b) A metallic cold water pipe bonded to a multigrounded neutral system.
- (c) Service ground of a multigrounded neutral power system.
- (d) Metallic service entrance conduit (except aluminum) bonded to the service entrance box of a multigrounded neutral system.

**Note:** If one of these grounds is not available a fused-type protector must be used.

**7.03** Subject to the grounding restrictions outlined in Para. 7.02, the fuseless protector is used as follows:

- (a) At any station served by open wire where bridling to NE drop wire is through Z block wire fusible link.
- (b) At stations where NE drop wire is directly connected to urban wire.
- (c) Where NE drop wire is connected through Z block wire fusible link to rural wire.

**Note:** The bridling between drop wire and open wire or rural wire must consist of at least two feet of Z block wire.

**7.04** Drop wire from an unexposed cable terminal into an exposed area exposes both the subscriber station and the distribution cable. Fuseless protectors are required at both ends of the drop. When drop is to be joined directly to a cable pair a fusible link is required as outlined in Para. 7.06.

#### Fused Station Protection And Requirements

**7.05** When the grounding requirements or bridling requirements outlined in Paras. 7.02 or 7.03 cannot be followed; a fused-type protector must be used.

#### Station Protection And Requirements (Buried And Underground)

**7.06** Fuseless station protectors may be used with buried distribution cable connected to exposed cable as follows:

- (a) When 24- or 26-gauge cable is so located that it will serve as a fusible link.

## SECTION 460-100-400CA

(b) When the buried distribution cable is 19 or 22 gauge and a cable terminal with a fusible link is provided.

*Note:* Either 24- or 26-gauge cable can be used as fuse cable in lieu of 7-ampere fuses at stations and central offices for protection of circuits exposed to power contact (fusible link).

**7.07** When the requirements outlined in Para. 7.06 cannot be met, a fused-type protector must be used.

**7.08** For any length of buried wire, bond the aluminum shield or armored wire to the ground terminal of the protector by means of the solderless connector. (See Table D).

**7.09** Service drops joined to exposed underground cable pairs will require the same type protectors as drop wire joined to exposed aerial cable pairs.



**Fig. 37 — Bridging Connector (See Table C)**

### 8. STATIONS REQUIRING SPECIAL PROTECTIVE MEASURES

**8.01** Special protective measures are usually required for stations located in the following areas:

- (a) At power substations or generating stations.
- (b) In atmosphere containing explosive gas, vapour, or dust.
- (c) Where privately owned circuits are in conflict or joint use with power circuits not suitable for general joint use.
- (d) When facilities are leased for the operation of FOREIGN signalling circuits which might impress excessive voltage or current on the telecommunication facilities.

*Note:* The protection required for the circuits listed in (a) through (d) will be on the service order. If it is not, consult your supervisor.

**8.02** There are some stations where protectors and special grounding arrangements are necessary, as follows:

(a) **Coin Telephones:** If the drop or line wire is exposed between the cable terminal and telephone, protectors are required.

(b) **Stations on Wood Poles:** If possible install the stations on a pole having a vertical ground wire connected to a multigrounded neutral. When a multigrounded neutral is not available and the station is served from a metal sheath cable, the protector is grounded to a ground rod. If the station is served from open or multiple wire, ground the protector to a ground rod.

*Caution: Do not install a station on a pole having a power vertical ground wire for lightning protection unless the ground wire is connected to a multigrounded neutral.*

(c) **Stations on Metal Poles:**

*Caution: Do not install stations on metal poles that support power circuits (open wire or in conduit) of 300 volts or more unless the pole is grounded to a multigrounded neutral or a metallic cold water pipe.*

(1) Fuseless protectors are required on metal poles supporting power circuits of 300 volts or more.

(2) When the conductors are exposed and the power circuits on the metal pole are less than 300V and the pole is bonded to a multigrounded neutral or low impedance ground, such as a metallic cold water pipe, a fuseless protector is required.

(3) When the conductors are exposed and the power circuits on the metal pole are less than 300V and the pole is **NOT** bonded to a multigrounded neutral or low impedance ground such as a metallic cold water pipe, a fused protector is required.

(4) When the conductors are unexposed and the power circuits on the metal pole are less than 300 volts, no protection is required.

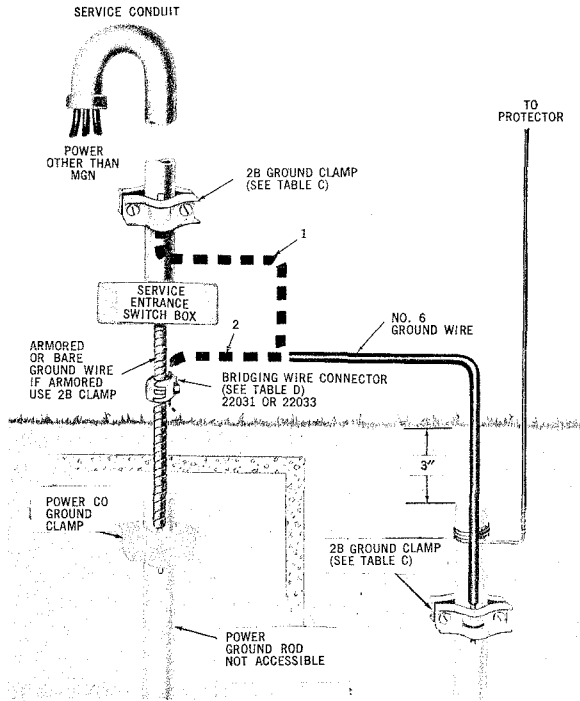


Fig. 38 — Power Other Than MGN Grounded to Inaccessible Ground Rod—No Water Pipe

**Selection of Protector Units**

8.03 If exposed drop or block wires are to be connected to unexposed cables at 49-type terminals, equip the terminals for station protection. To do this, use 3A1B-3 (F-53458) terminal blocks. Remove the 2A1B protector units and replace 2A1A protector units.

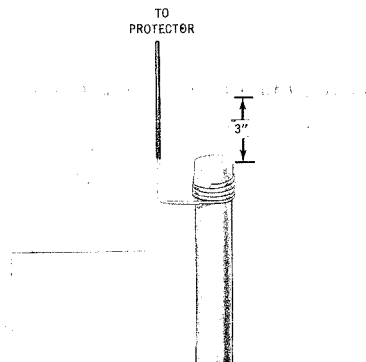


Fig. 39 — Grounding to Telephone Ground Rod—Water Pipe, Power Ground, or Metallic Structure Not Available

9. MAINTENANCE OF STATION PROTECTORS

9.01 Station protectors prevent damage to station equipment from abnormally high voltage or current. Protectors should be inspected on every visit to customer's premises.



*Inspect ground wire, ground clamp and ground tag. Change the ground connection to use the best grounding medium present. Report any substandard conditions to supervision for later correction. If the best medium available is a ground rod, make sure that the telephone rod is bonded to the power ground rod, and to the lightning rod if present.*

- (a) Replace protectors, protector units, fuses, mountings, and associated parts which are defective or are in poor condition.
- (b) If No. 26 protector block used with 98A protector is excessively pitted turn over on opposite side, if in good condition. If both sides are pitted, replace protector block.
- (c) Replace operated fuses on the 98A protector with No. 11CBB fuses using a 216B or an equivalent tool. Make certain the fuses are

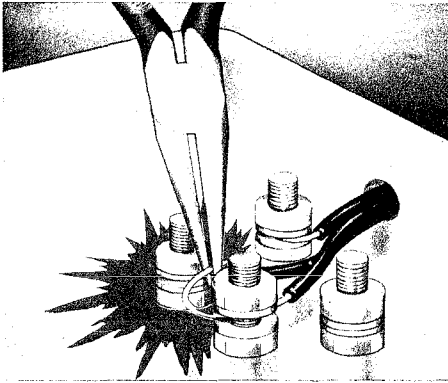
installed with the slots facing into the wells located in the base.

- (d) Replace all 2-type protector units that ground the line. Defective units to be returned to storeroom.
- (e) Inspect wire terminations at protector for tightness, broken wire, corrosion, foreign matter, etc.

9.02 Fused protectors on stations served by grounded metal sheath cable should be converted when the station is visited except when it would be necessary to place a new ground wire. The number of converted fuseless protectors which may be connected to ground wire of various sizes is covered in Table C.

9.03 When station protectors served by metal sheath cable are in locations where atmospheric corrosion is a problem, use a 123A1A fuseless protector and 150A cover in place of existing protector and associated protector mounting.

9.04 Model 123A1A-type protectors are equipped with 2B1A protector units (Fig. 1). These units may have a slotted screw type cap or a 3/8-inch hexagonal head metal cap which requires a 216B or equivalent type tool for removal.



●  
**DON'T BE A  
SHORT CIRCUIT  
ALARMIST**  
●

**KNOW YOUR**

**SPECIAL SAFEGUARDING MEASURES (SSM)  
And SPECIAL SERVICE PROTECTION (SSP)**



**1. INTRODUCTION**

**1.01** This section covers Special Service Protection, Special Safeguarding Measures and includes description and use of protective devices.

**2. SPECIAL SERVICE PROTECTION (SSP)**

Consists of the following measures:

**2.01** Physical protection and identification at all appearances (including multiple and bridged appearances) in central office, outside plant and station wiring.

**2.02** Identification as SSP in all records and orders affecting these services, e.g., assignment records, Engineering records, transfer orders, circuit orders, special service order, layout cards, test centre records, etc.

**2.03** The obtaining of a clearance from the appropriate serving test centre or serving plant service centre before performing any work involving the service.

**3. SPECIAL SAFEGUARDING MEASURES (SSM)**

Consists of all the measures prescribed for SSP plus the following:

**3.01** No bridged taps or multiple appearances of cable pairs.

**3.02** Physical protection of service entrance by placing the service in cable — not in exposed service wiring from unlocked terminals. (Optional)

**3.03** Inside wiring in conduit. (Optional)

**3.04** Identification as SSM in all records and orders affecting these services, e.g., assignment records, Engineering records, transfer orders, circuit orders, special service orders, layout cards, test centre records, etc.

**3.05** The obtaining of clearance from the serving test centre or serving plant service centre at least 24 hours prior to the actual time the release is required. This is essential to permit the customer to dispatch personnel or to make other arrangements to protect service during the release or reroute period.

**Note:** The extent of the application of these optional features to minimize the possibility of interference or unauthorized access, will be governed by customer requirements, the additional cost involved and the feasibility of providing such protection.

**4. PROTECTIVE DEVICES**

**4.01** Common protective devices used on special service circuits are shown in Fig. 1 through Fig. 15.

**4.02** Red Identification Ring #7 is a red cellulose-acetate spiral ring, 3/8 inch in diameter. This indicator is also used to identify circuits. The split-ring feature of this indicator permits placing or removing indicator on terminated wires. (See Fig. 1.)



**Fig. 1 — Red Identification Ring #7**

**4.03** Binding post caps, Fig. 2 through 8, are neoprene caps for use on cable and wire terminals as protection against accidental contacts on special service lines, and as a means of minimizing faceplate leakage in distribution cable terminals. Binding post caps are supplied in red and black. Red caps are intended for use on special service lines, and the black caps are for general use, such as faceplate leakage, battery and generator pairs.

● The B binding post caps, Fig. 2, are for use on nonworking posts of T type cable terminals, and wire terminals.



**Fig. 2 — Binding Post Cap B**

- The C binding post caps, Fig. 3, are for use on working posts of T type cable terminals, and wire terminals.



Fig. 3 - Binding Post Cap C

- The D binding post caps, Fig. 4, are for use on 7A fuses installed in L-type fuse chambers.



Fig. 4 - Binding Post Cap D

- The E binding post caps, Fig. 5, are for use on NC, NF, MD3208, MD3209 and the QTC type cable terminals.



Fig. 5 - Binding Post Cap E

- The F binding post caps, Fig. 6, are for use on terminals equipped with insulation crushing washers such as 30-2, 57B, and 59A-type connecting blocks and the QTD1A cross-connecting terminals.



Fig. 6 - Binding Post Cap F

- The G binding post caps, Fig. 7, are for use on 30-type connecting blocks and QTD7B cable terminals.



Fig. 7 - Binding Post Cap G

- The H binding post caps, Fig. 8, are for use on 31-type connecting blocks, and QTD3A cable terminals.



Fig. 8 - Binding Post Cap H

4.04 The KS-14539 guard protector, Fig. 9, is a red plastic hood designed to cover the heat coils and springs on protected-type PBX frames.



Fig. 9 - Guard Protector KS-14539

4.05 Binding post insulators are open-ended fibre insulators for use on binding posts to prevent accidental contacts. These insulators are designated No. 1, 2, 3, and 6, and are shown in Fig. 10. Binding post insulators have a red enamel finish, for use on SSM and SSP circuits and natural for other uses.

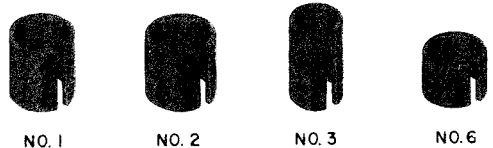


Fig. 10 - Binding Post Insulators

- No. 1 insulators, Fig. 10, are for use on binding posts having  $\frac{3}{8}$ -inch hexagonal nuts, and on 7T fuses.

- No. 2 insulators, Fig. 10, are for use on binding posts having 7/16-inch hexagonal nuts, and on 7A fuses.
- No. 3 insulators, Fig. 10, fit the screw binding posts of BD, BE and BF cable terminals.
- No. 6 insulators, Fig. 10, are for use on terminations of the alarm and contactor circuits in T pressure contactor-terminals and 3-pair gas-tight terminals.

4.06 Terminal punching insulators are opened fiber insulators for use on terminal punchings to prevent accidental contacts. These insulators are designated No. 4, 5, and 7 and are shown in Fig. 11. Terminal punching insulators have a red enamel finish for use on SSM and SSP circuits and natural for other uses.



Fig. 11 – Terminal Punching Insulators

- No. 4 insulators, Fig. 11, are 1/2 inch in length and are used on terminal strips.
- No. 5 insulators, Fig. 11, are 5/8 inch in length and are also used on terminal strips.
- No. 7 insulators, Fig. 11, are for use on cable conductor terminating lugs of the C- and E-type protector mountings.

4.07 The QGF1A guard consists of six red plastic terminal insulators joined together, Fig. 12, designed to protect one row of two beam terminals on the 66-type connecting block. This multiple guard may be cut with diagonal pliers to fit the number of terminals required.



Fig. 12 – QGF1A Guard

4.08 The QGF1B guard consists of a single red plastic insulator Fig. 13 designed to protect one, three beam terminal on a 66-type connecting block.



Fig. 13 – QGF1B Guard

4.09 The 12A guard, Fig. 14 is a metal framework covered top and bottom with insulating material, and provided with a latch spring, which must be deflected to remove guard. It is designed for use on 444 type jacks and is now Manufactured Discontinued. (Superseded by NS20353 L1 Fig. 16)

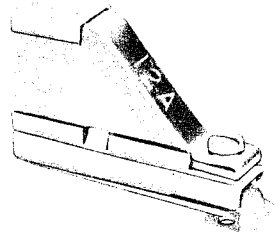


Fig. 14 – 12A Guard

4.10 The 12B guard, Fig. 15 is the same as the 12A guard except it has a locking screw for maximum security. It is also Manufactured Discontinued. (Superseded by NS20353 L1 Fig. 16).

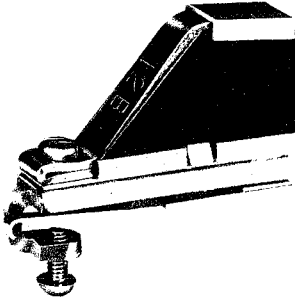


Fig. 15 - 12B Guard

4.11 The NS20353 L1 guard consists of a red plastic insulator detail, Fig. 16, provided with a snap lock fit for security. This guard is designed for use on 444 type jacks, and supersedes the 12A and 12B guards.

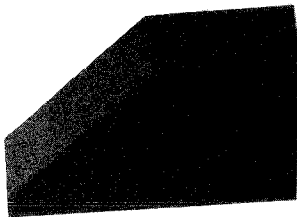


Fig. 16 - NS20353 L1

4.12 The NS16576 L5 Plate Designation consists of a red plastic insulator detail, Fig. 17, designed to protect the jumper cross-connecting terminals on 300 connectors



Fig. 17 - NS16576 L5 Plate Designation

4.13 The NS16576 L6 Plate Designation consists of a red plastic insulator detail, Fig. 18, designed to protect test contacts on 300 connectors.



Fig. 18 - NS16576 L6 Plate Designation

4.14 The QGF2A guard, Fig. 19, consists of a red plastic insulator detail designed to protect single conductor connections per pair of terminals on the 302BQ9 Connector cross-connection terminal strip.



Fig. 19 - QGF2A Guard Single

4.15 The QGF2B guard, Fig. 20 is the same as above, except designed to protect double conductor connections per pair of terminals. (e.g. B.M.F.).



Fig. 20 - QGF2B Guard Double

4.16 The NS19478 L1 guard, Fig. 21 consists of a red plastic insulator detail designed to protect a pair of conductors in the test field of a 302 Connector.

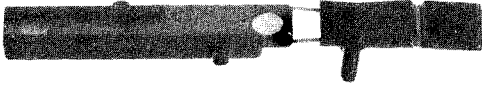


Fig. 21 - NS19478 L1

**SECTION 460-110-100CA**

**4.17** The Cap, Post, Binding Number 4104,

Fig. 22 consists of a red plastic insulator detail designed to protect a pair of terminals on the Jumper Wire Interface (JWI) Connector Module for use with Serving Area Concept (SAC).



**Fig. 22 — Cap Post Binding Number 4104**

**4.18** The B wire marker, Fig. 23, is an all temperature pressure, sensitive, red plastic strip used on B connector at access points in dedicated plant.



**Fig. 23 — Marker Warning — Form E-5190**

**5. WHICH CIRCUITS REQUIRE SSP OR SSM?**

Typical circuits requiring SSP or SSM are:

Air Raid Warning Systems

Data Transmission — Telephone and Telegraph

Program Transmission

Facsimile or Telephotograph

Teletypewriter

Channels for signal transmission

Emergency Reporting Systems

PBX Battery and Generator Supply for emergency service — Hospitals, Police, Fire, Power and Government Security Locations.

**6. WHY ARE SSM AND SSP IMPORTANT?**

To avoid energizing special equipment or interrupting messages accidentally. (It is essential that special service lines be maintained in full operative condition at all times.) Remember—some special service lines operate on shunted circuits, while others operate on a grounded or an open circuit.

**7. HOW DO YOU AVOID DIFFICULTIES?**

By:

- Obtaining authorization before working on a special circuit.
- Using SSP or SSM when required.
- Not running down a terminal with a shunt when trying to locate a pair.
- Exercising care to avoid accidental contact with other lines.
- Obtaining authorization before removing any SSP.

**7A. WHAT OTHER BELL SYSTEM PRACTICES DEAL WITH S.S.M. AND S.S.P.?**

- 069-120-801 — Central Office
- 660-200-301 — Test Centre
- 680-520-010 — Plant Assignment

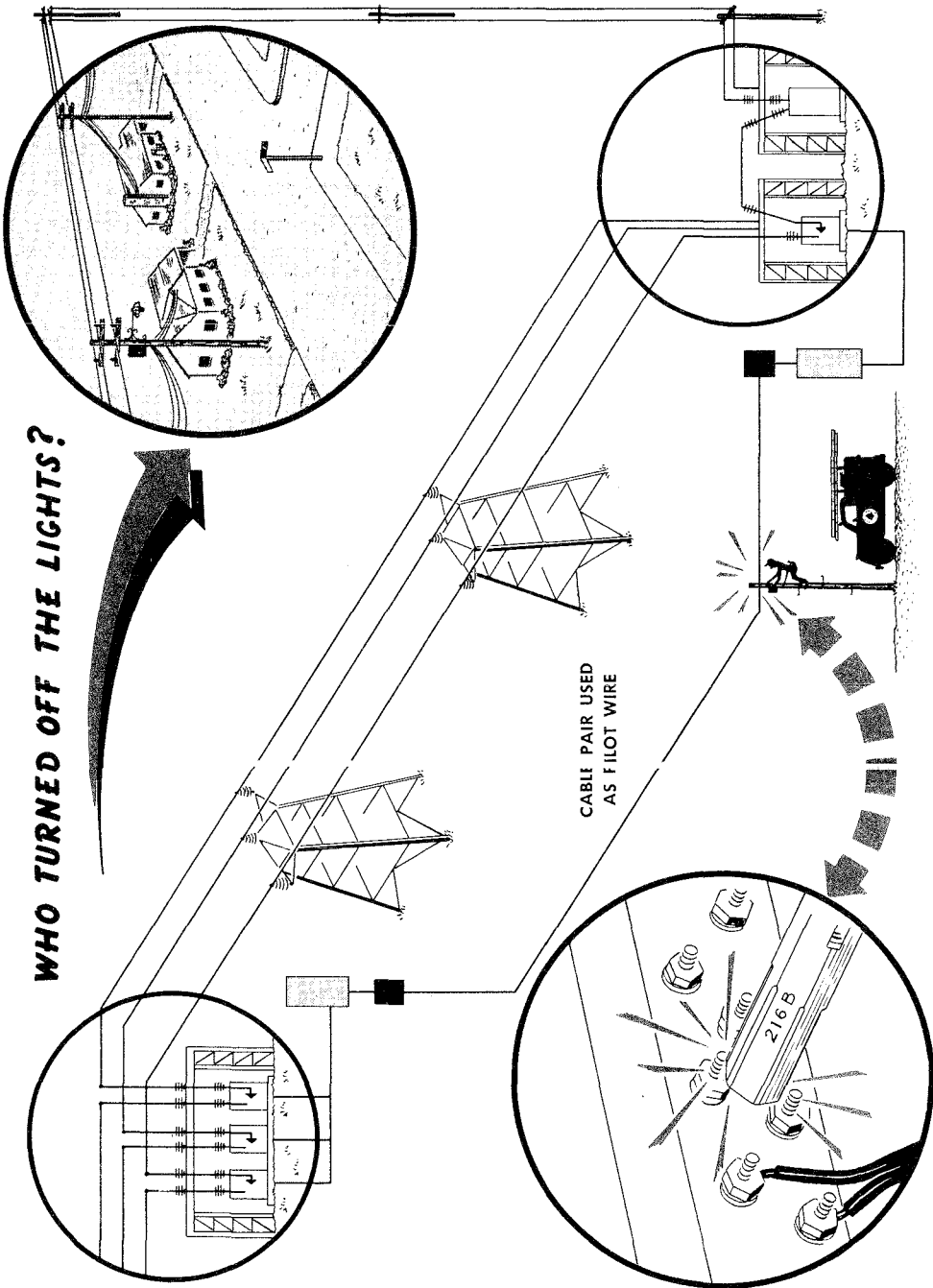


Fig. 24

8. INSTALLING AND REMOVING SSP

8.01 Special Service Protection must be installed or removed upon receipt of Form E-4106, shown in Fig. 25.

8.02 After proper authorization is received (Form E-4106), install SSP as shown in Fig. 26 through 45.

RSP 4425-82 SPECIAL SERVICE PROTECTION 6-4106 110-021

BINDING POST INSULATORS TERMINALS PROTECTOR GUARD DEVICES DISTRIBUTING FRAMES

CENTRAL OFFICE AVENUE DATE AUG. 12/64 SERVICE ORD. NO. 3276

DATE ISSUED AUG. 10/64 BY FB WORK ORD. NO.  TRANS. NO.

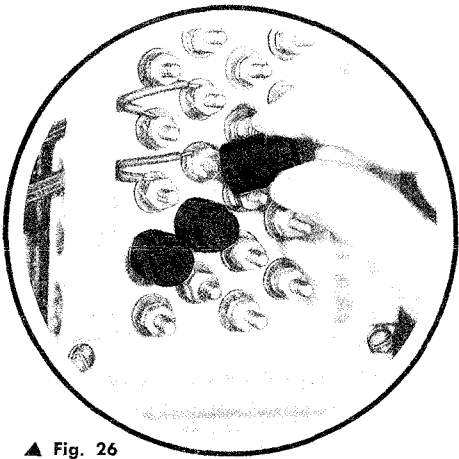
COPY FOR FIELD FOR INFORMATION CALL 870-1112

PLACE AND OR REMOVE SPECIAL SERVICE PROTECTION AT LOCATIONS LISTED.

CABLE	PAIR	BP	TERMINAL LOCATIONS	COLOUR			PROTECTION	
				B	T	R	PLACE	RE-MOVE
	21	157	7 R-1027 MOUNTAIN				X	
			10 F-984 MOUNTAIN	BL	W	BL	X	
			25 R-1059 ST ANTOINE	BL	W	S	X	
			52 BASEMENT 1000 DORCHESTER	OR	W	B	X	

WORK COMPLETED BY \_\_\_\_\_ DATE \_\_\_\_\_ O.K. NO. \_\_\_\_\_

Fig. 25 — Facsimile of Form E-4106 ▶



▲ Fig. 26

- Install binding post caps as follows:
1. Clean faceplate.
  2. Run down the nut of the binding post finger tight.
  3. Place cap over binding post and push until seated against faceplate.
  4. When a wire is terminated on a binding post which is to be protected, ensure that the wire is positioned inside the binding post wire entrance hole.

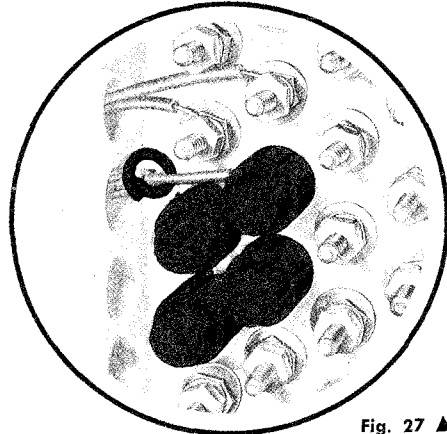


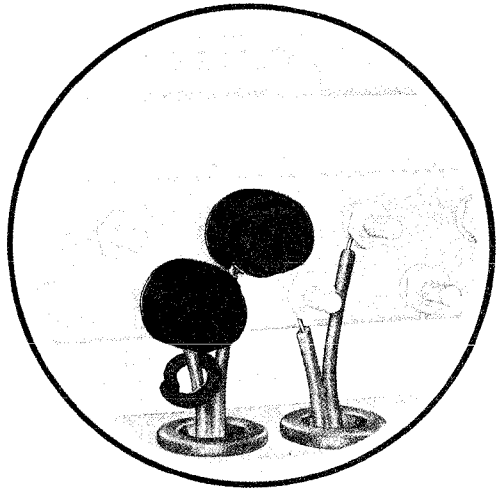
Fig. 27 ▲

Split-ring feature of the red identification ring #7, permits placing or removing indicator on terminated wires.



Fig. 28 ►

SSP used in fixed count binding post type cable terminals, wiring terminals, or fuseless protected terminal blocks.



◀ Fig. 29

SSP used with 42A connecting block.

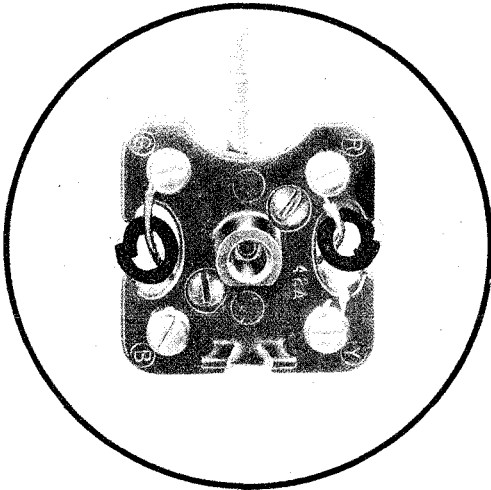
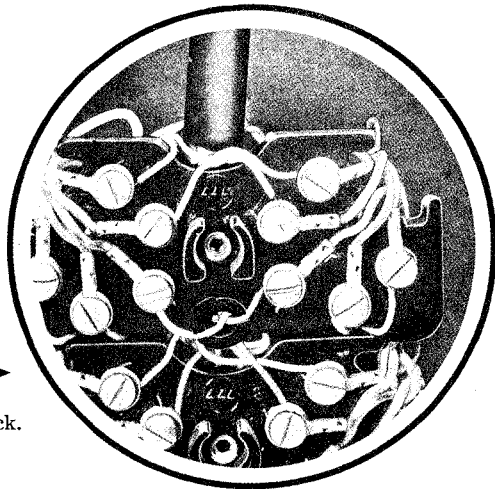
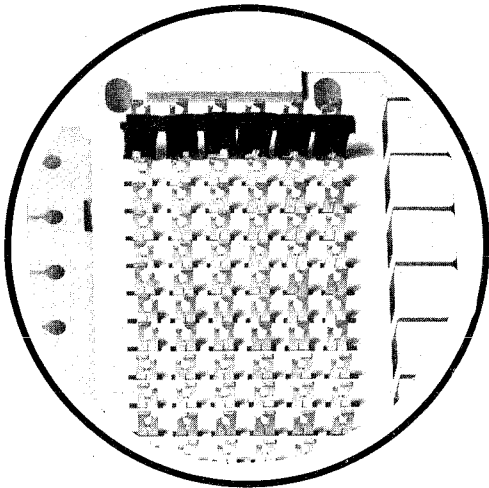


Fig. 30 ►

SSP used with 44A connecting block.



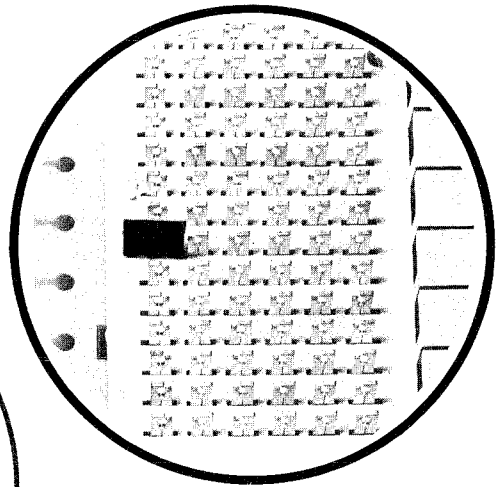


◀ Fig. 31

QGF1A Guard installed on 66-type connecting block.

Fig. 32 ▶

QGF1B Guard installed on 66-type connecting block.



◀ Fig. 33

D binding post caps installed in L-type fuse chamber.

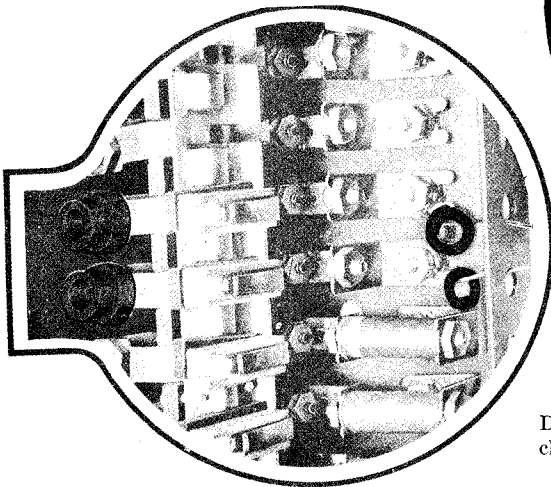


Fig. 34 ►

E binding post caps and indicator used with MD3208, MD3209, 49-type, and QTC type cable terminals.

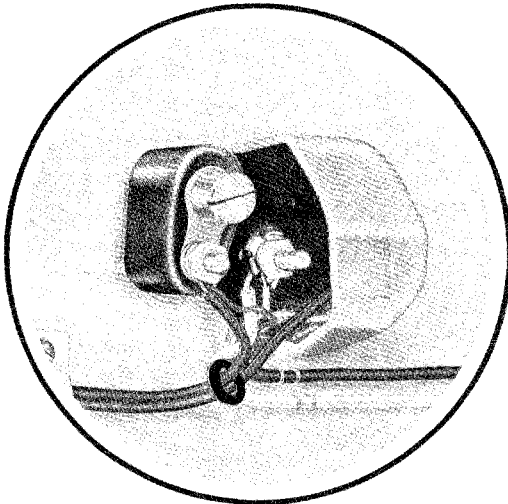
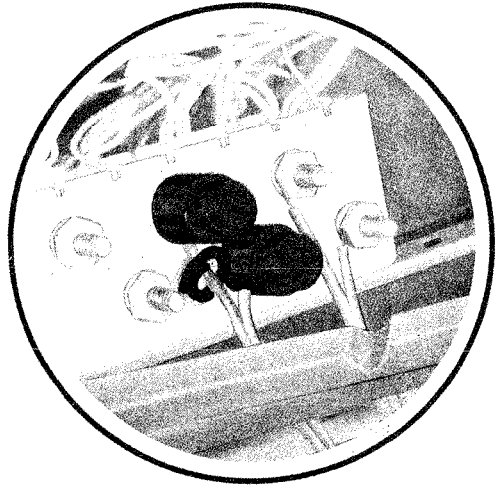


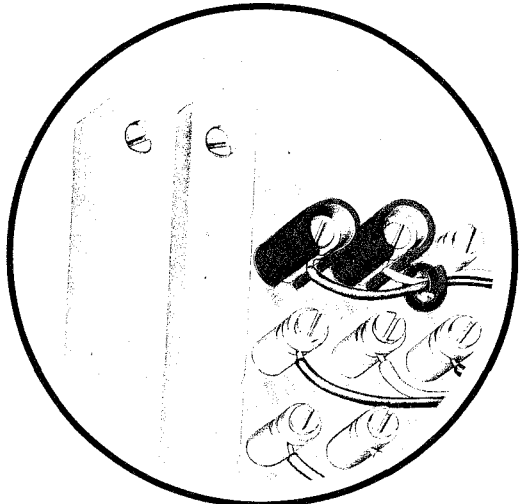
Fig. 36 ►

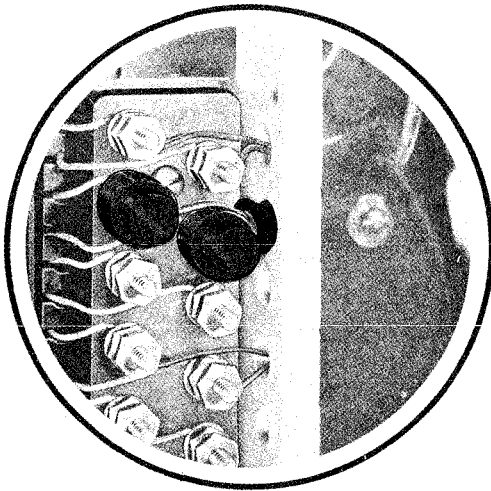
No. 3 binding post insulators installed in BD-type cable terminal. Remember—SSP is required at both ends of cross-connecting wires.

Where the insulator fits loosely, place a piece of tape around the binding post inside the insulator.

◀ Fig. 35

Indicator used with station protector 123A1A. The 150A cover (shown cut away) gives added security.



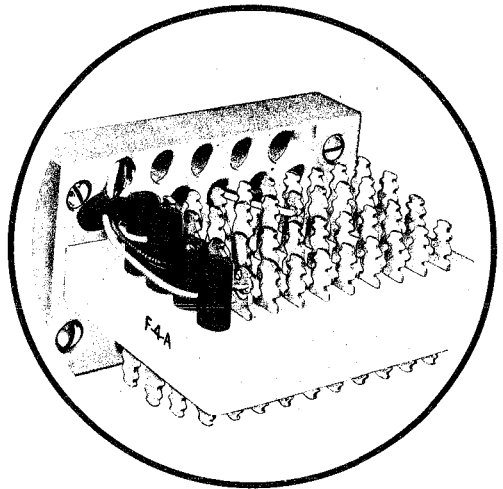


◀ Fig. 37

A 30-type connecting block with SSP.

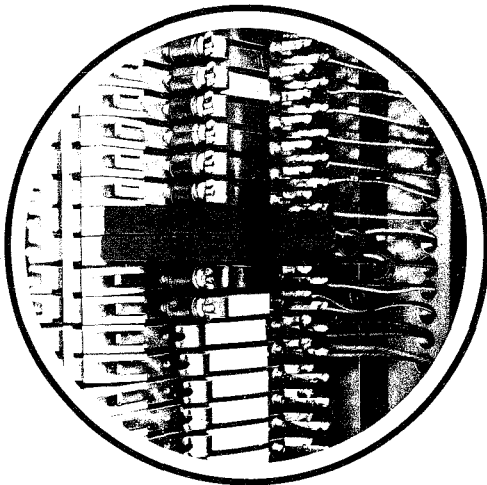
Fig. 38 ▶

Typical terminal strip with SSP. Terminal punching insulators shown here are No. 4 (short) and No. 5.



◀ Fig. 39

Protected PBX frame with KS-14539 Guard, terminal punching insulators on cable and jumper terminals and #7 identification ring. *All frame appearances on each special circuit must be protected. SSP must be placed at each end of the jumper wire.*



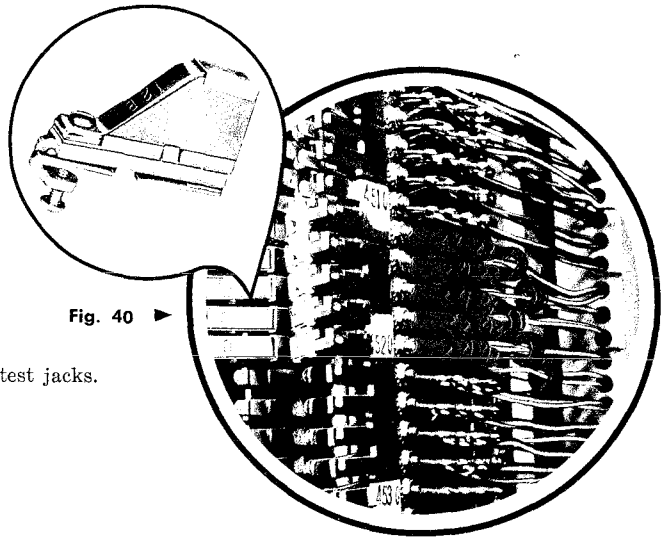


Fig. 40

SSP on frame equipped with 444A test jacks.

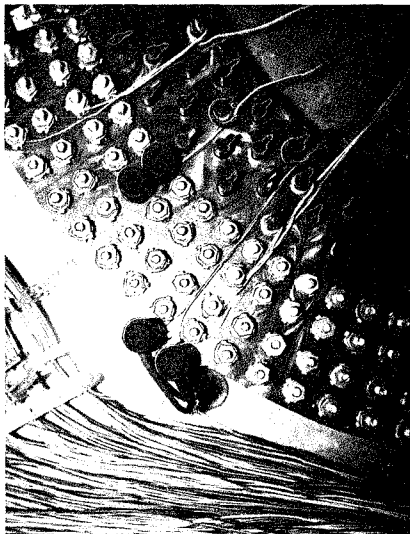


Fig. 41 – SSP on QTD1A Cross Connecting Terminal

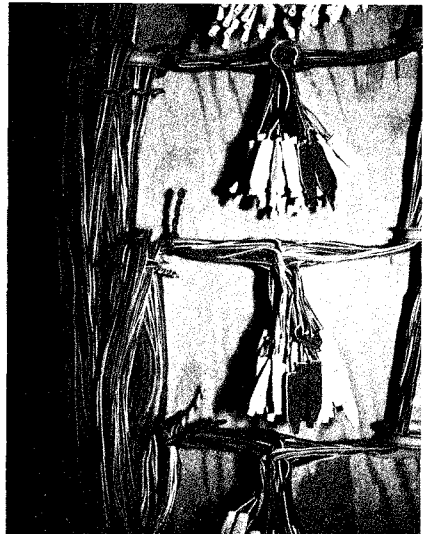


Fig. 42 – Identification Rings and E-5190 Warning Marker used at Access Point of Dedicated Plant

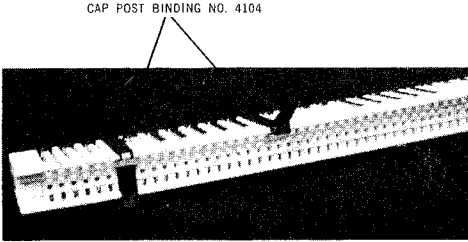


Fig. 43 — Cap Post Binding Installed on Connector Module in JWI Cabinet

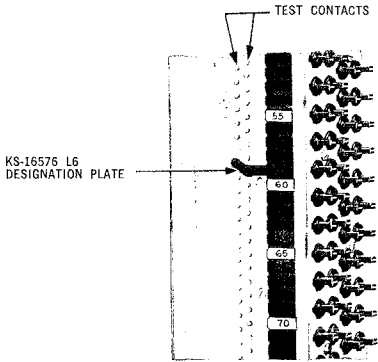


Fig. 44 — Designation Plate Installed Over Test Contact Terminals

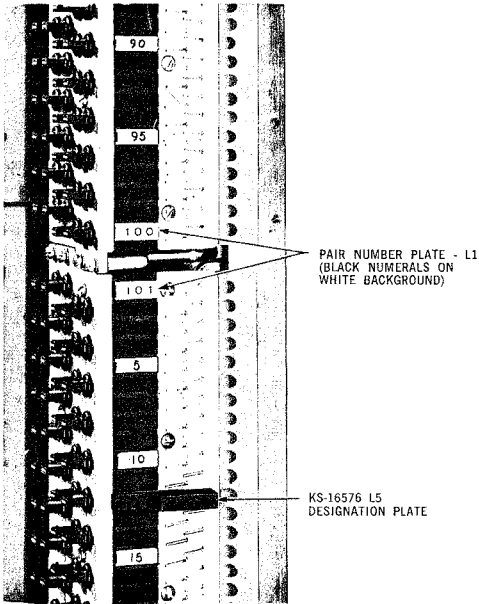


Fig. 45 — KS-16576, L5 Coloured Designation Plate (Red) Installed on 300 Type Connector



SELECTION OF ROUTE FOR STATION WIRE AND CABLE

1. INTRODUCTION

1.01 This practice covers the general factors to be considered in running station wires or cables.

1.02 This section is reissued to include information and requirements pertaining to the use of false ceilings for concealing telephone plant.

1.03 Figure 1 shows the various points which should be considered in selecting routes for wires. Consideration should be given to the location of the telephone, protector, and ground clamp, as well as to the drop wire and point of entrance, before planning the wire route.

1.04 Clearances over public and private swimming pools are not covered by Safety Codes or other practices, however, for reasons of safety, sanitation, and appearance, aerial drop wire crossing over swimming pools should be avoided.

2. SELECTION OF BUILDING ENTRANCE

2.01 Inspect building thoroughly to locate service entrance conduit and use it if provided.

2.02 Where no service entrance conduit has been provided, select an entrance point from Table A.

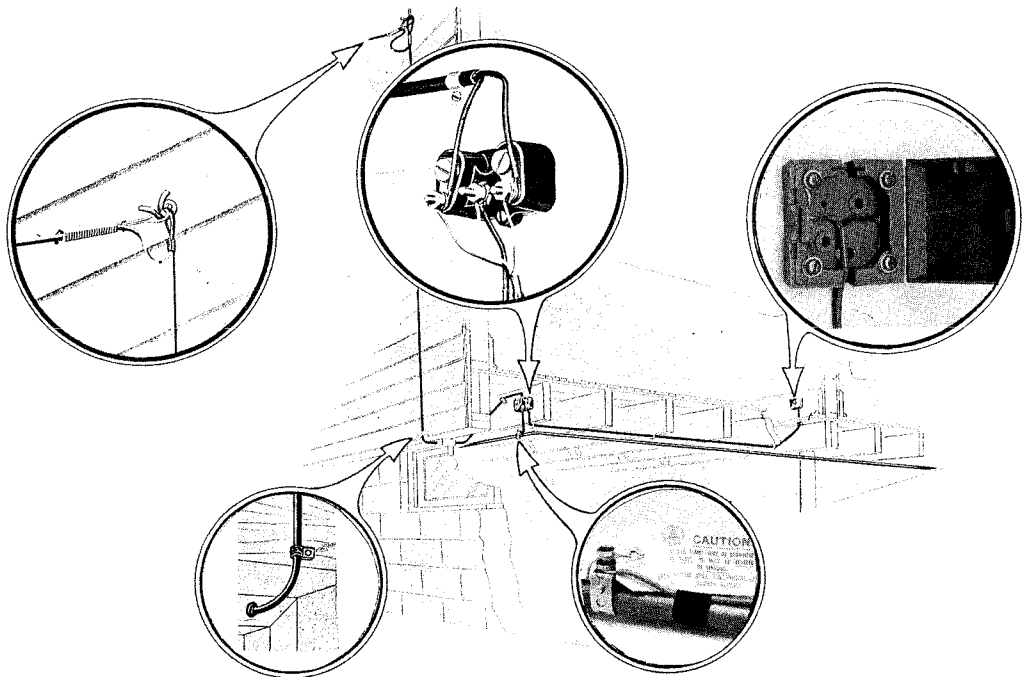


Fig. 1 — Typical Wiring Routes



TABLE A

Type of Construction	Point of Entrance				
	Wooden Window Frame	Wooden Door Frame	Foundation Sill	Outside Wall*	Metal Window Frame†
Masonry or Brick	•	•			•
Wood or Stucco on Wood (basement ceiling unplastered)	•	•	•	•	
Wood or Stucco on Wood (basement ceiling plastered)	•	•		•	

\* To wire direct to set or connecting block.

† See Para. 2.03.

**Unusual Building Entrances**

**2.03** For entrances at metal frame windows and doors:

- Do not make entrance through metal door frames.
- When metal window frame is set in masonry or bricks, enter as shown in Fig. 2.

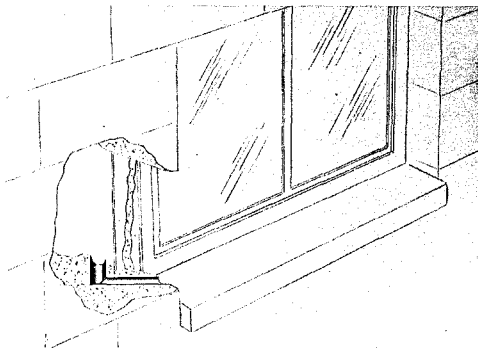


Fig. 2 — Entrance at Metal Window Frame

- Cut slot in seam of brick as shown in Fig. 3. Be sure slot is deep enough so wire is cleared when shutter or screen is operated.

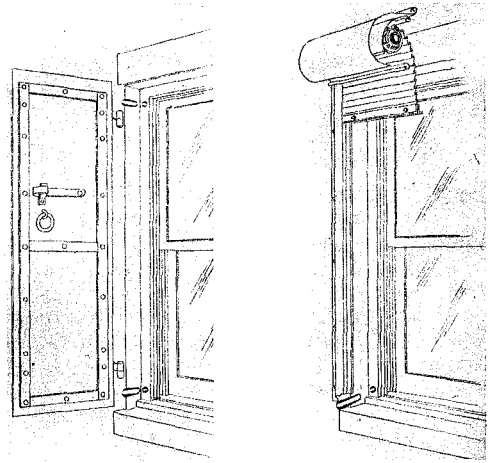


Fig. 3 — Entrance at Shutter of Fire Screen

- Locate hole as shown in Fig. 4 so as to avoid drilling through two shingles.

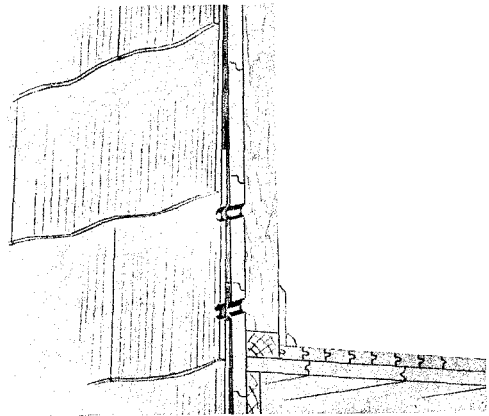


Fig. 4 — Entrance Through Composition Shingles

**3. GENERAL LOCATION REQUIREMENTS**

**3.01 Facilities to Look For**

- Are conduits or raceways provided?
- Is there wire or cable in place which can be re-used?

- Can wire or cable be concealed or run inconspicuously?
- Will wire run present a good appearance?

**3.02** Follow customer's wishes, considering:

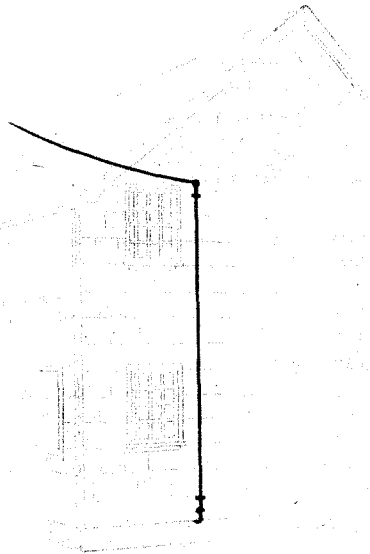
- Good safety sense.
- Minimum future maintenance.

**3.03 Common Sense Factors**

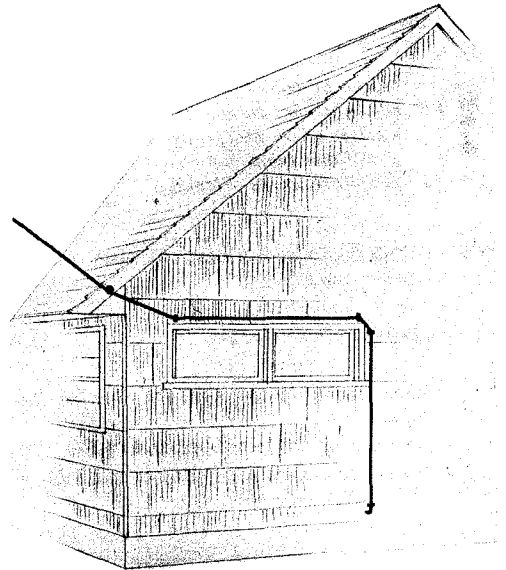
- Run wire or cable horizontally or vertically in a straight line.
- Choose colour of wire or cable to blend with or match surfaces.
- Use baseboards or other trim where conduit is not provided.
- Make use of wooden surfaces in preference to others where possible.
- Keep runs as short as is consistent with good appearance and minimum maintenance.

**3.04** After location of first attachment has been determined, consider the following factors:

- Locate the drop or block wire run on the building with a view to permanency, accessibility, and appearance.
- On building walls finished with stucco, rigid composition shingles, brick veneer, and similar materials, locate attachments on wood trim where practicable.
- Locate preferably on the rear and side walls of a building (see Fig. 5).
- Place horizontal run above the reach of the public (see Fig. 6).
- Locate the run so as to require the minimum length of wire and as few turns as practicable.
- Do not run wires in front of signs, doors, windows, fire escapes, awnings, etc.
- Do not place wire runs on walls which are likely to be built against.
- Do not run wires diagonally on a building, except in short runs necessary to change direction of run.



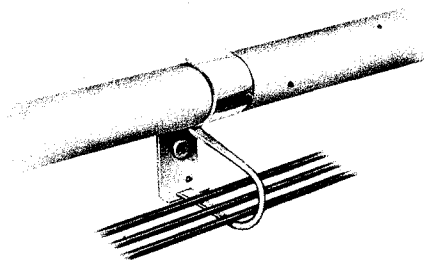
**Fig. 5 — Typical Drop Run**



**Fig. 6 — Horizontal Drop Run**

## SECTION 461-200-200CA

- Avoid attachments on tin, sheet metal, or other materials requiring frequent repairs or renewals.
- Avoid locating on intermediate structures of a deteriorated or temporary construction. Select alternate route.
- When making a wire run on a building wall near cable, proceed in one of the following ways:
  1. Use rings installed with cable clamps as shown in Fig. 7.
  2. Remove nails or screws that hold cable clamps and replace with drive rings.
  3. Install separate wire run paralleling cable.



□ Fig. 7 — Drop Wire and Cable



*Wires or cables shall not be placed in conduits or raceways which contain electric wires not properly separated by partitions from the space provided for telephone wires or cables.*

### 3.05 AVOID the following locations when placing wire or cable:

- Damp locations.
- Locked storerooms, etc.
- Temporary structures.
- Runs that provide support for foreign objects.
- Excessively hot locations, steam pipes, etc.
- Locations where wires and cables will be subjected to abrasion.

3.06 In explosive atmospheres, locate and install wiring as covered by specific instructions in accordance with the equipment being installed.

□ NOT BELL CANADA STANDARD

### 3.07 Requirements for Ground Wire Runs

- Make runs as short as possible.
- Locate wire where it is least likely to be disturbed.
- Run protector ground wire exposed, except where conduit has been provided.
- Do not place protector ground wire in ring runs.
- Signal ground wire may be placed in rings.
- When existing protector ground wire has become enclosed by a ceiling or partition, re-use if continuity can be checked and ground clamp is accessible.

## 4. MAKING USE OF WIRE DISTRIBUTING SYSTEMS

### 4.01 Distributing Systems in Office Buildings

- Office buildings are generally provided with an exchange cable terminated in a main terminal on the ground floor and distributed to each floor through a building or house cable.
- In some cases, the exchange cable may be distributed directly to each floor.
- For information regarding the building conduit system, consult the plan at the main terminal or contact the building superintendent.

### 4.02 Various Types of Wire Distributing Systems

- Steel underfloor duct system.
- Fiber underfloor duct system.
- Conduit underfloor wall system.
- Metal base raceways.
- Wood base raceways.
- Molding raceways.
- Cable.

### 4.03 Distributing Systems in Apartment Houses, Hotels, and Hospitals

- Generally, these buildings provide a main terminal location in the basement or ground floor and a wall conduit system to each apartment or room.
- In large buildings, there may be house cable from the main terminal to each floor with a terminal on each floor and conduits to the various apartments or rooms from the floor terminal.

### 4.04 Wiring Systems in Private Residences

- Some homes are equipped with a built-in protector cabinet and/or conduit to the proposed location of the telephone.

- Conduit may be provided to a service entrance head from the protector cabinet.
- Pull-wires or specially built wiring channels may be provided.
- Telephone outlets may have been placed and wired during construction of building.
- Always inspect for or inquire about these facilities and make use of them wherever possible.

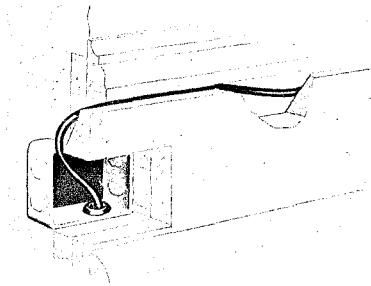
- Where trim cannot be followed, run wires horizontally or vertically but not diagonally.
- Choose colour of wire and fasteners to match or blend with colour of surface where wires are attached.

**5. SELECTION OF EXPOSED WIRING ROUTE**

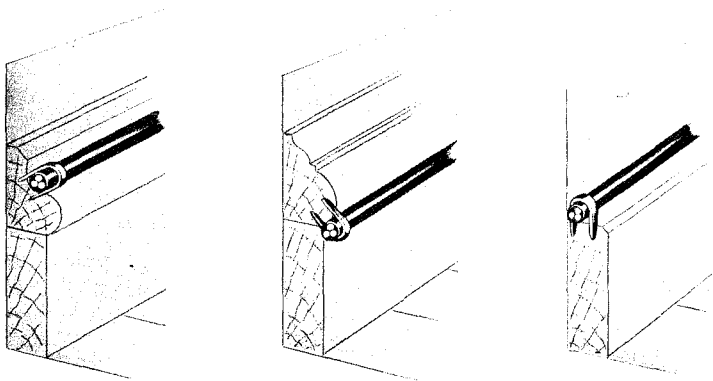
**5.01** In general, an exposed wire route should be used only where no concealing facilities are available.

**5.02** *Wiring in Finished Rooms and Offices*

- Run wires along baseboards, on top of picture moldings, or on door or window casings, so that they will be as inconspicuous as possible (see Fig. 8, 9, and 10).



**Fig. 8 — Wiring from Conduit to Baseboard**



**Fig. 9 — Wiring on Baseboards**



**Fig. 10 — Wiring in Picture Moldings**

## SECTION 461-200-200CA

### 5.03 *Wiring in Cellars, Factories, Storerooms, etc*

- Place wire and cable where they will be least likely to be broken or detached. Provide protection if necessary.
- Consider the shortest, most direct right-angle route unless otherwise specified.
- Select a wire route which will be safe and accessible.
- Follow the ceiling line rather than baseboard in heavily travelled passageways.
- If necessary to follow chair rails, use the underside.
- When possible, follow joists.
- If necessary to span joists, run wiring not more than 3 inches from wall (see Fig. 11).

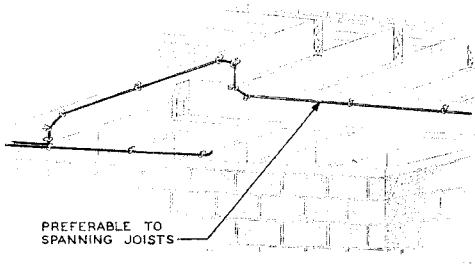


Fig. 11 — Spanning Joists

### 6. USING CONCEALED AND OVERFLOOR CONDUITS

#### 6.01 *Consider the following factors when using conduits:*

- Whenever conduit is provided for telephone wires and it meets the prescribed specifications, it should be used.
- Check to be sure conduit does not contain electrical wires not associated with telephone equipment. If it does, follow local instructions.
- Place sufficient number of wires for possible future use in accordance with local procedures.
- Conduit systems are part of the permanent installation and are furnished, installed, and maintained by the building people.

- Consult the building people before extending wiring beyond the provided system.
- When necessary to provide wiring through concrete floors or similar construction from floor-to-floor and conduit is not provided, inspect premises for pipes through floor which may be provided for such use.

### 7. PLACING STATION WIRE AND CABLE IN BUILDING RISER SHAFTS

#### 7.01 Building riser shafts are generally of two types:

- **Closed riser shafts** consist of a series of closets, aligned vertically one above the other, usually beginning in the basement and extending throughout the height of the building. The closets are interconnected by a cable slot or pipe sleeves through the floors.
- **Open riser shafts** usually extend from the basement to the roof of the building with no floor separations. They are similar in construction to elevator shafts.

#### 7.02 To conform with the National Building Code and the Canadian Electrical Code, observe the following when placing wire and cable in building riser shafts:

##### **Closed Riser Shafts**

- Any cable may be placed if fire stops are placed in the slots or floor sleeves at each floor. Fire stops should consist of a packing of asbestos or fibre glass with a thin topping of water seal or equivalent. The individual who places a cable through a sleeve or slot should ensure the fire stops are placed.

##### **Open Riser Shafts**

- The use of polyethylene sheath cable is restricted unless it is enclosed in a non-combustible conduit.
- Lead sheath cable and PVC jacketed station wire and inside wiring cable may be placed with no restrictions.

## 8. CEILING DISTRIBUTION SYSTEMS

### 8.01 *Precautions To Be Taken When Working in False Ceilings*

- Have the customer remove and replace ceiling tiles.
- Take the necessary precautions when using stepladders as covered in Section 081-740-921.
- Avoid working over desks, furniture and other objects.
- Be careful not to damage the finished surfaces of the adjacent tiles.
- Do not exert downward pressure on the tiles when working.
- Avoid placing tools or material in false ceiling space.
- Take extreme caution when working above light fixtures.
- Do not strain the conduit or ceiling supports when pulling in cable.
- Wear insulating gloves if power contact is suspected.
- Wear a helmet if the headroom is limited.

### 8.02 *Placing Wire and Cable in False Ceilings*

- Normally the customer will provide conduit, cable trays or wire loops to support the cable or inside wire. In some locations it may be necessary to support the inside wire or cable on the main runners and/or cross runners (T Bars) of the false ceiling hardware.
- The end of the conduit will normally be found by removing the centre tile within the zone. (See Telephone Zones Part 9).
- Place a key cable for each 100 sq. ft. of floor space.
- Leave sufficient slack in each cable for the amphenol connector to reach any telephone set within the zone. (See Telephone Zones Part 9).
- Spare cable or cables should be coiled and supported at the end of the zone conduit.

- Spare cables should have sufficient slack for the amphenol connector to reach any location within the zone.
- Cable runs supported by the ceiling hardware should be placed as close as possible to the hangar wires.
- Where zone conduits are not provided, all cables will run to the centre point of their respective zones and from there distributed to the telephone set location within the zone. At the centre point in the zone, support all cables with a cable tie or equivalent.
- Cables supported by runners should not exceed 500 prs. (20 cables of 25 prs) within a 4 foot section of the ceiling.
- Avoid placing cables on or against light fixtures.

## 9. TELEPHONE ZONES IN FALSE CEILINGS

**9.01** The floor area to be served shall be divided into telephone zones consisting of not more than 400 to 600 square feet. (See Fig. 12).

**9.02** To feed the telephone zone, the building will usually have a continuous length of 2-inch conduit in the ceiling space, properly supported to permit the pulling-in of cables. This conduit should extend from the nearest telephone terminal or apparatus closet and left open-ended at the midpoint of each telephone zone as illustrated in Fig. 12.

**9.03** The length of cable required to be placed in the conduit to reach any telephone set location in a respective zone should be marked on the end of the conduit with the zone number (as per Para. 10.01 (a) in the appropriate closet).

**9.04** For floor areas where the 2-inch conduit to the telephone zones is not available and where a number of inside wiring cables are to be placed loosely in the ceiling, cable supports may be required. These cable supports should be located on 5-foot centres and must be provided by the building owner to avoid damage to the ceilings because of cable weight.

SECTION 461-200-200CA

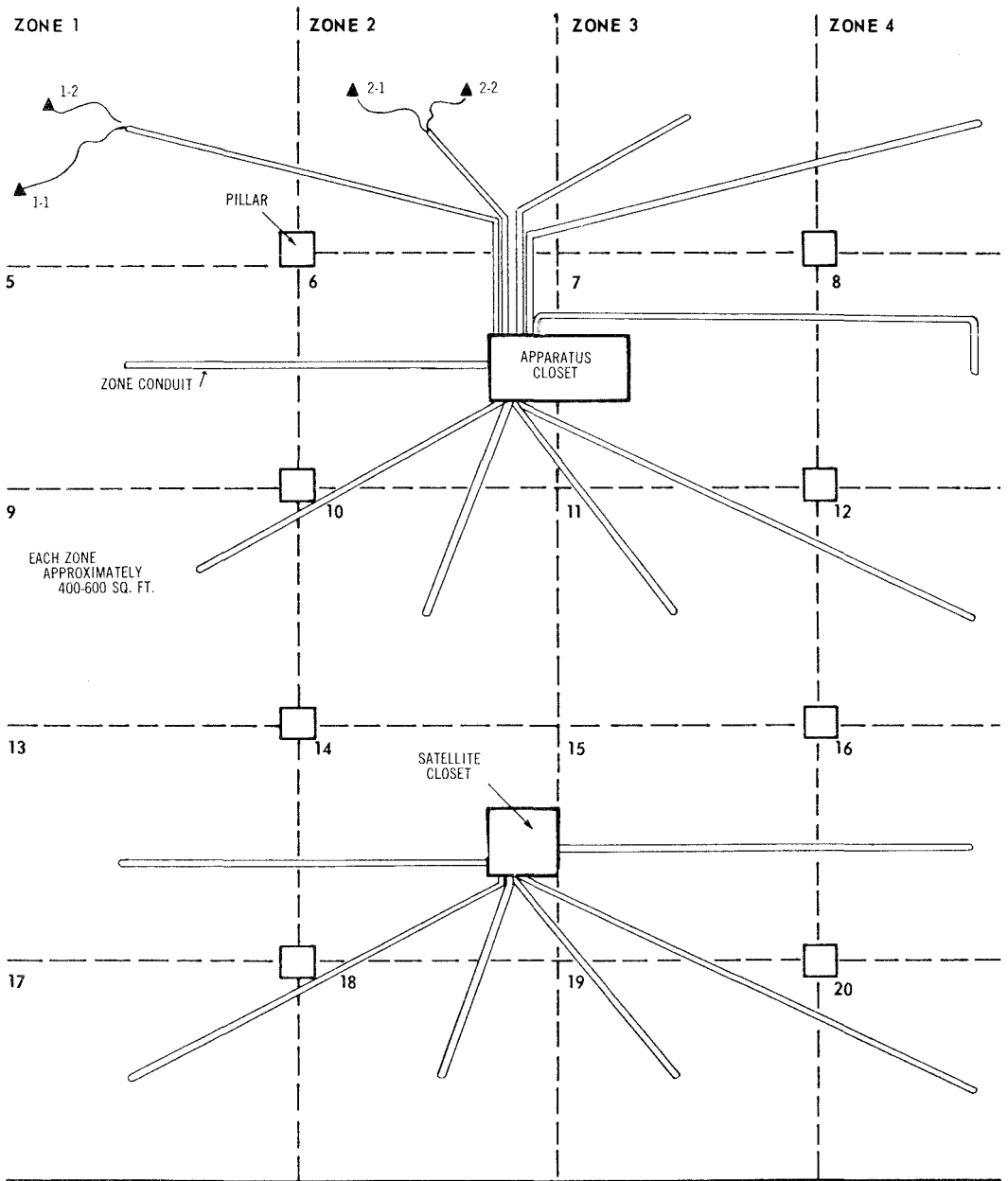


Fig. 12 – Typical Zone Layout Hung Ceiling System

## 10. DESIGNATING CABLES AND CONDUITS IN FALSE CEILINGS

**10.01** On hung ceiling distribution systems, zoning concepts should be employed regardless of whether or not zone conduits are provided by the customer. The following designating procedures should be used:

- (a) A number should be assigned to each zone (see Fig. 12).
- (b) Zone conduits (when provided) shall be numbered in the ceiling and at the riser end with the appropriate zone number. With the customer's permission, a marker unit cable or facsimile should be placed on the "T" rail directly beneath the conduit end so that the zone may be readily identified from the floor.
- (c) Each cable and wire should be assigned a number within its zone and will be labelled with the zone number and the specific cable number. (e.g.: 3-1 indicates that the cable appears in Zone 3 and that it is cable No. 1 in that zone.) These numbers should be placed on the amphenol or wire at the set end and on the 66-type block at the riser end.

**10.02** When dedication of cables to connecting blocks is not possible due to lack of space, cables, wires, amphenols and service fittings are still numbered.

**10.03** Designation numbers used on service fittings, amphenols, cable and connecting blocks are called "marker unit cable."

**10.04** To facilitate future rearrangements and changes, plan layouts, and associated documents should be stored in manilla envelopes (Form 2019) or a similar container, affixed to the apparatus mounting or backboard, at the equipment location.

## 11. WIRING METHOD, CEILING TO DESK LOCATION Utility Column

**11.01** A utility column is a post placed between the ceiling and floor in conjunction with the ceiling distribution system as shown in Fig. 13. It is used for the concealment of communications wiring from the ceiling to the desk. It can also be used as an extension of electrical outlets for the same purpose.

**11.02** The utility column is a commercial product and if used must be supplied and installed by the customer. Utility columns with power facilities will require C.S.A. approval.

**11.03** Inter-connection with customer-owned wiring in utility columns is *not* permitted.

**11.04** The utility columns should be attached, or supported, by the main "T" rails in the ceiling as shown in Fig. 14.

**11.05** Usually when the utility columns are being placed or have been placed, they are subjected to being slightly shifted. Such movement invariably causes the "T" rail to become warped, marred or bent. Excessive bending of rails may cause tile to fall down.

**11.06** There are several different models of utility columns available to the customer: (Figs. 13 to 15)

(a) Some models have to be fished from the floor to the ceiling when the cable is equipped with an amphenol connector, as the space in the column is not large enough for the amphenol connector.

(b) Other models allow the amphenol connector to be pushed down the column from the ceiling to the outlet on the column. Cover plates may be equipped with knock-outs to fasten the amphenol connectors or may be capable of housing amphenol connectors in the column, exposing the mounting cord only.

(c) Some models of the utility columns have removable sides which allows the cable to be placed without fishing. It is simply laid in the column and the side cover replaced. Adapters are available for these columns to house up to 5 amphenol connectors.

## 12. USE OF WALLS OR PARTITIONS

**12.01** The following conditions apply if hollow core walls or partitions are used for concealing telephone wire and cables:

- (a) The hollow core walls or partitions must be clear and unobstructed.



**SECTION 461-200-200CA**

(b) Opening of walls and partitions and the installation of outlet boxes are the responsibility of the building owner or subscriber.

(c) A pull wire is required from all outlet boxes to the approved supporting structure above the suspended ceiling.

(d) Use only vertical pull wire runs. If bends or horizontal runs are necessary, conduit is required.

*Note:* Fulfilling the above items shall not be at the expense of the Telephone Company.

**12.02** Inside wire and cable will have to be exposed where the customer does not follow the requirements outlined in Para. 12.01.

**12.03** If fire blocks, sound deadening materials, or insulation is used in the construction of walls or partitions, conduit must be run from the

outlet to the approved supporting structures above the suspended ceiling.

**12.04** Where it is planned to use walls or partitions to conceal inside wiring cables down from ceilings, a minimum of 1-1/2 inch diameter space is required to permit the connector end of the cable to pass from the top of the wall to the outlet box above floor.

**12.05** The following are recommended:

(a) 1-1/2 inch conduit in wall or partition to outlet box (Fig. 16).

(b) 1-1/2 inch square clear space between partition sections with snap-on panel or cover (Fig. 17).

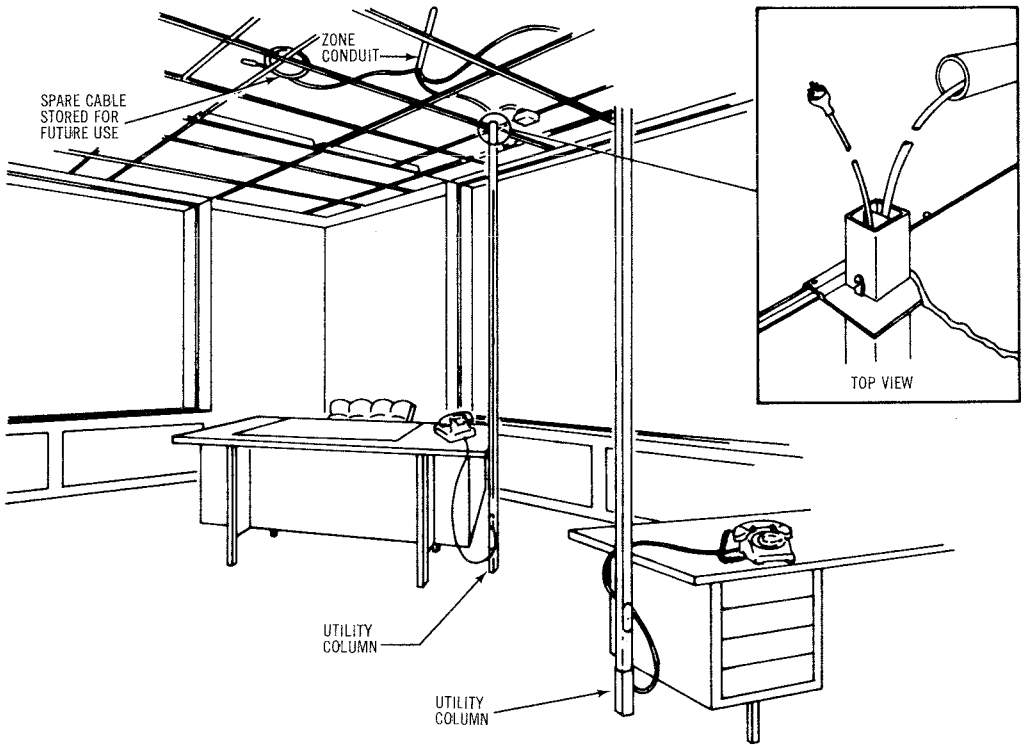


Fig. 13 - Wiring Method With Utility Columns

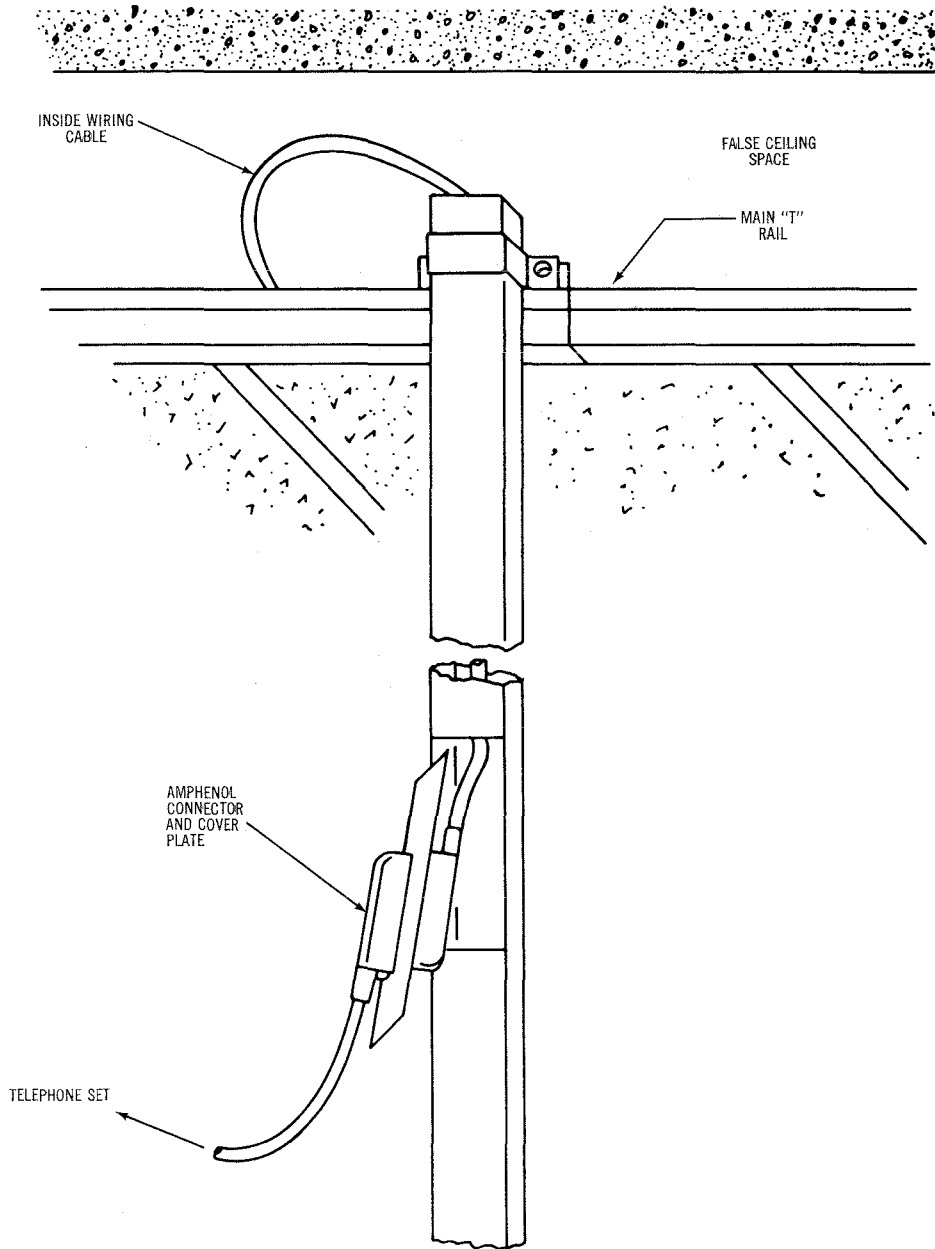


Fig. 14 – Utility Column Installation

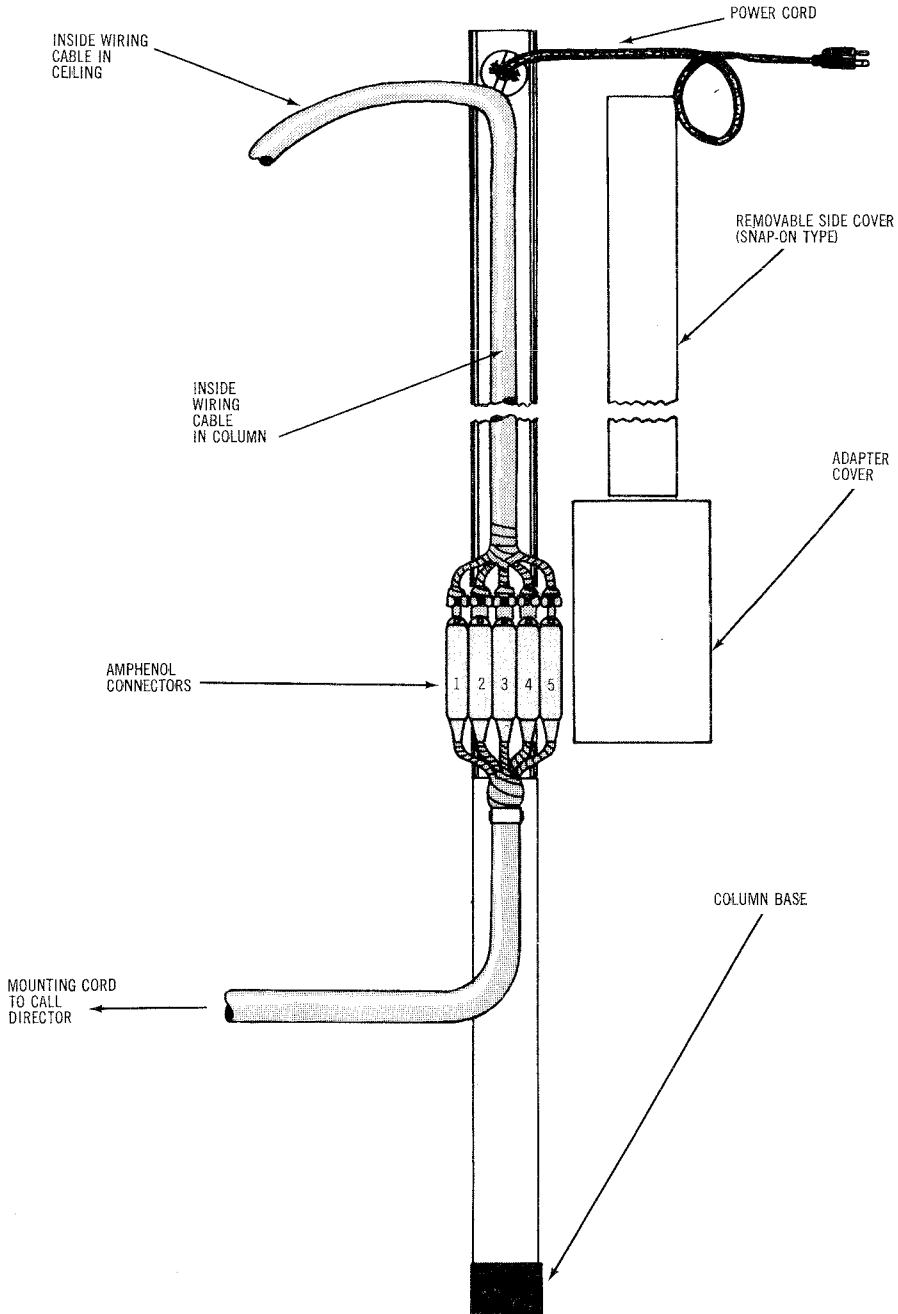


Fig. 15 — Typical Utility Column  
(With Covers Removed)

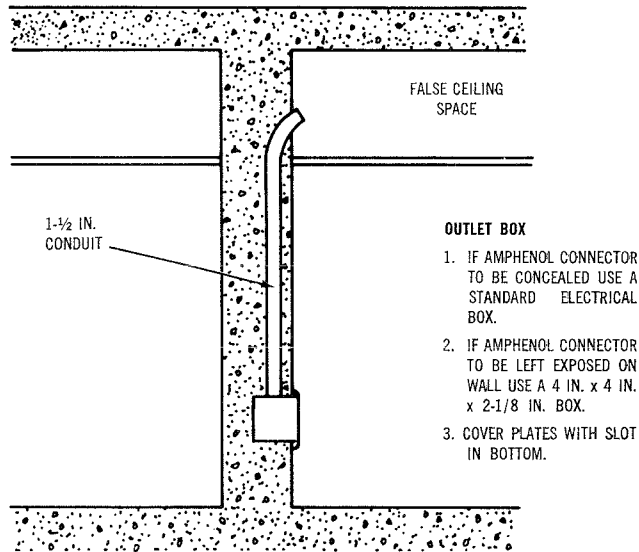


Fig. 16 — Conduit in Wall

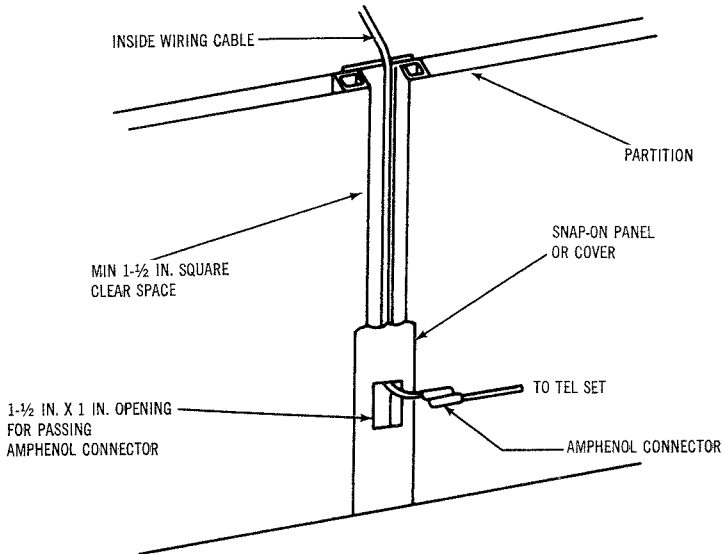


Fig. 17 — Partition Design

**HANDLING WIRE AND CABLE**

**1. INTRODUCTION**

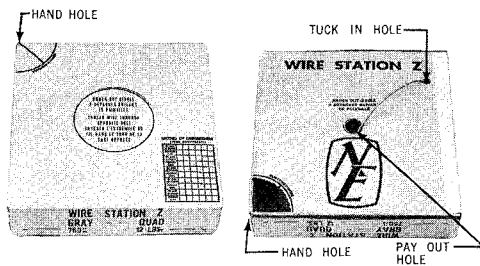
**1.01** This section covers the general factors to be considered when handling wire and cable and terminating and identifying conductors.

**1.02** This section is reissued to revise Fig. 1 to show hand holes in the carton to provide easier handling.

**2. REMOVING WIRE OR CABLE FROM A COIL**

**2.01** To remove jacketed wire from the carton:

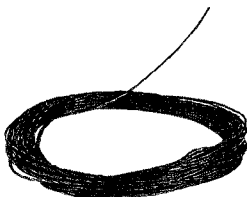
- (1) Punch out perforated holes from carton.
- (2) Place carton on floor and feed wire from centre of coil (Fig. 1).
- (3) Use small hole to tuck in wire after use of coil.



**Fig. 1 — Feeding Jacketed Wire**

**2.02** To remove twisted wire from a coil:

- (1) Place coil flat on floor so that inner end will feed from coil in a counterclockwise direction.
- (2) Feed from centre of coil (Fig. 2).



**Fig. 2 — Removing Twisted Wire**

**2.03** To pay out cable, remove cable from coil by paying it off from outside of coil (Fig. 3).



**Fig. 3 — Paying Out Cable**

**3. STRIPPING CABLE**

**3.01** To strip plastic-covered inside wiring cable:

- (1) Slit end of cable sheath with diagonal pliers for approximately 1 inch.
- (2) Locate nylon jacket-splitting cord under sheath and wrap the cord around end of long-nose pliers.
- (3) Grasp cable with one hand. With long-nose pliers in other hand pull nylon cord through cable sheath. Keep pliers close to jacket.

**3.02** To strip braid or older plastic-covered inside wiring cable without jacket-splitting nylon cord. Use inside wiring cable stripper as follows:

- (1) Support cable between stripper and last attachment.

- (2) Angle tool to cable and insert point just under outer covering.
- (3) Pull stripper toward free end of cable (Fig. 4).

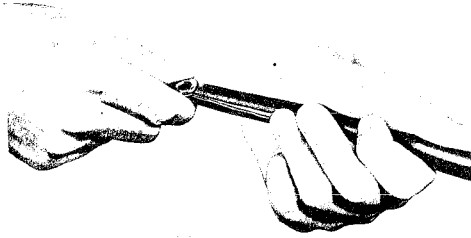


Fig. 4 — Using Cable Stripper

**4. SKINNING CONDUCTORS (STATION WIRE, BLOCK WIRE, AND CABLE), FIG. 5, 6, 7, 8, AND 9**

**4.01** To remove the jacket and conductor insulation from Z station wire proceed as follows:

**3.03** To strip lead-covered cable:

- (1) Score a groove around cable at butt marks with a crimping knife.
- (2) Cut deep enough so sheath will break when bent.
- (3) Slide section of sheath off free end of cable.
- (4) When a long length of sheathing is to be removed, score in 4-inch lengths and remove each section.

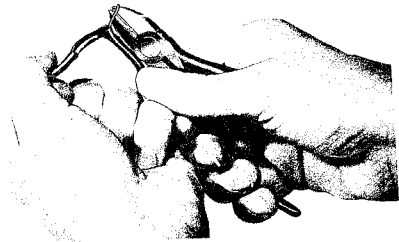
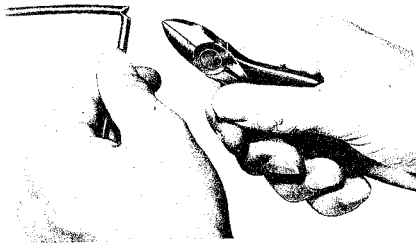


Fig. 5 — Skinning Jacketed Wire

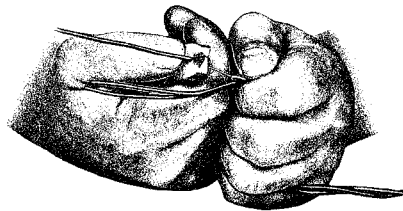


Fig. 6 — Skinning Twisted Wire

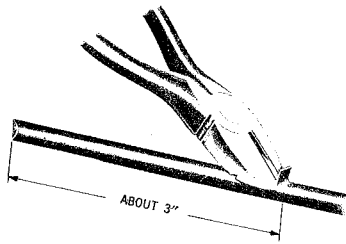


Fig. 7 – Skinning Flat Rubber Cordage

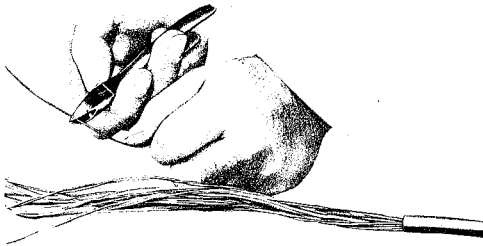


Fig. 8 – Skinning Conductors of Inside Wiring Cable

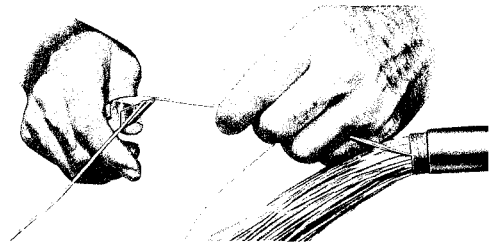


Fig. 9 – Skinning Conductors of Lead-Covered Cable

(2) Grip the end of both conductors, as illustrated in Fig. 5, and pull at an approximately 45° angle to cable. Do not exert too much pressure on diagonal pliers to avoid cutting conductors. Rip approximately 6 in. of cable jacket.

(3) Release pliers and grasp both conductors with hand. Continue pulling until the desired length of conductors are exposed.

(4) Cut off end portion at point of initial cut in Step 1.

(5) Remove insulation on conductors as shown in Fig. 8.

**4.02** To remove conductor insulation from twisted wire proceed as follows:

(1) Untwist conductors from desired length to be terminated. Hold at this point between thumb and index finger.

(2) Place conductor in groove on jaws of diagonal pliers as illustrated in Fig. 6, squeeze and pull in direction as shown. Repeat for other conductors.



5. TERMINATING WIRE AND CABLE CONDUCTORS, FIG. 10, 11, 12, 13, AND 14

- Hold wire properly to avoid catching in threads of binding post.
- Turn wire around binding post in same direction as the screw or nut is turned to tighten.
- Avoid overlapping wire around binding post.
- Keep insulation approximately 1/8 inch from the washer.

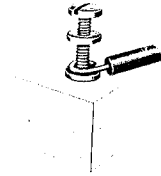
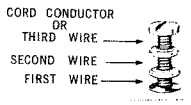
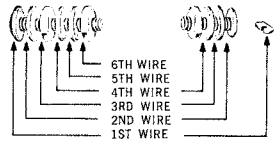


Fig. 10 – Terminating on Screw Terminal

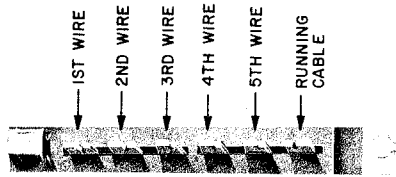


42 or 44 Type



30 Type

31 Type



66 Type

Fig. 11 – Terminating Sequence, Connecting Blocks

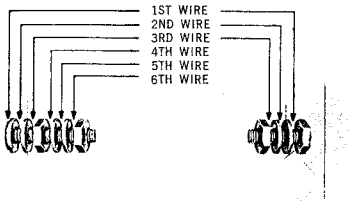


Fig. 12 – Terminating Sequence, Distributing Terminal

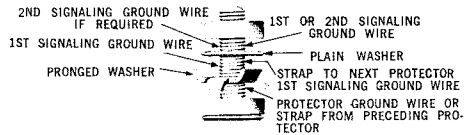
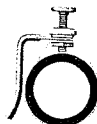


Fig. 13 – Ground Connection Sequence at Protector



PLACE GROUND WIRE UNDER WASHER AND TIGHTEN LOCKNUT FIRMLY

Fig. 14 – Terminating Sequence, Ground Clamp

**6. IDENTIFICATION OF TRACER**

6.01 Means of identifying conductors are:

- Coloured threads in the insulation. Table A).
- Coloured insulation.
- Tracer ridges in the insulation. Table B).
- Coloured dots in the insulation.

**7. INSIDE WIRING CABLE COLOUR CODES**

7.01 D inside wiring cable is available in light-olive gray and ivory in pair sizes 6, 12, and 16. The following pair sizes are available in light-olive gray only: 21, 25, 50, 75, and 100.

- The 6 to 25 pair sizes are layer construction. That is, one or more pairs are used for the core and the other pairs are wrapped around to form the cable.
- The 50 to 100 pair sizes are unit construction. That is, each cable is composed of 2 to 4 units of 25 pairs each with each unit bound with a binder colour (Table C).
- Individual conductor insulation is identified by the even-count colour coding scheme.
- See Tables D, E, F, and G for colour codes.

7.02 E inside wiring cable is a sheathless cable intended for use in rewiring homes during construction. It is available in six, twelve and 25 pair sizes.

Individual conductor insulation is identified by the even-count colour coding scheme. (See Table D for colour codes).

**TABLE A**  
**COLOURED THREAD**  
**OR**  
**SOLID-COLOURED INSULATION**

Colour of Tracer	Number of Conductors		
	Pair	Triple	Quad
Red	•	•	•
Green	•	•	•
Yellow		•	•
Black			•

7.03 Cable Wiring Power Plant is available in gray in six pair size. It is intended for use in bridging power plants to stations and PBX systems. (See Table H for colour code).

**TABLE B**  
**RIDGED CONDUCTORS**

Tracer Ridge	Number of Conductors	
	Pair	Triple
Double		•
Single	•	•
Plain	•	•

**TABLE C****BINDER COLOURS**

Unit No.	Binder Colour	Pair
1	BL-W	1-25
2	O-W	26-50
3	G-W	51-75
4	BR-W	76-100

**TABLE D**  
**CONDUCTOR COLOUR CODES**  
**D INSIDE WIRING CABLE (LIGHT-OLIVE GRAY AND IVORY)\***

Pair	Ring Wire	Tip Wire	Binder Color for 50, 75, and 100 Pairs
1	BL-W	W-BL	BL-W
2	O-W	W-O	
3	G-W	W-G	
4	BR-W	W-BR	
5	S-W	W-S	
6	BL-R	R-BL	
7	O-R	R-O	
8	G-R	R-G	
9	BR-R	R-BR	
10	S-R	R-S	
11	BL-BK	BK-BL	
12	O-BK	BK-O	
13	G-BK	BK-G	
14	BR-BK	BK-BR	
15	S-BK	BK-S	
16	BL-Y	Y-BL	
17	O-Y	Y-O	
18	G-Y	Y-G	
19	BR-Y	Y-BR	
20	S-Y	Y-S	
21	BL-V	V-BL	
22	O-V	V-O	
23	G-V	V-G	
24	BR-V	V-BR	
25	S-V	V-S	
26-50	Repeat First 25 Colours		O-W
51-75	Repeat First 25 Colours		G-W
76-100	Repeat First 25 Colours		BR-W

\* 21-, 25-, 50-, 75-, and 100-pair cable available in light-olive gray only.

**TABLE E**  
**CONDUCTOR COLOUR CODES**  
**D CABLE (BROWN OR IVORY)\***

Pair	Ring Wire	Tip Wire
1	BL	W
2	O	
3	G	
4	BR	
5	S	
6-10	Repeat First 5 Colours	R
11-15		BK
16-20		Y
21-25		V
26	BL-W	W
27	O-W	
28	G-W	
29	BR-W	
30	S-W	
31-35	Repeat Colours 26-30	R
36-40		BK
41-45		Y
46-50		V
51	BL-R	W
52	O-R	
53	G-R	
54	BR-R	
55	S-R	
56-60	Repeat Colours 51-55	R
61-65		BK
66-70		Y
71-75		V
76†	R	W

\* Manufacture Discontinued.

† Substituted for last pair in each cable.

**TABLE F**  
**CONDUCTOR COLOUR CODES**  
**STANDARD C CABLE\***

Pair	Ring Wire	Tip Wire
1	BL	W
2	O	
3	G	
4	BR	
5	Slate	
6	BL-W	W
7	BL-O	
8	BL-G	
9	BL-BR	
10	BL-S	
11	O-W	W
12	O-G	
13	O-BR	
14	O-S	
15	G-W	
16	G-BR	W
17	G-S	W
18	BR-W	
19	BR-S	W
20	S-W	W
21-40 41-60	Repeat First 20 Colours	R
		BK
61-75	Repeat First 15 Colours	R-W
76†	R	W

Note: D inside wiring cable of 101-pair size is constructed with a red-white pair (pair 101) in the center of four units. Each unit is colour coded the same as the first 25 pairs in the 26 pair, D inside wiring cable, as shown in the table above. Each complete unit of 25 pairs is bound with a different coloured cotton binder.

**TABLE G**  
**CONDUCTOR COLOUR CODES**  
**D INSIDE WIRING CABLE (BEIGE)\***

Pair	Ring Wire	Tip Wire	Binder Color for 50, 75, and 100 Pairs
1	BL	W	BL-W
2	O		
3	G		
4	BR		
5	S		
6-10	Repeat First 5 Colours	R	
11-15		BK	
16-20		Y	
21-25		V	
26-50	Repeat First 25 Colours		
51-75			G-W
76-100			BR-W

\* Manufacture Discontinued.

**TABLE H**  
**CONDUCTOR COLOUR CODES**  
**CABLE WIRING POWER PLANT (GRAY)**

Pair	Ring Wire	Tip Wire
1	BL-1W	BL-2W
2	O-1W	O-2W
3	G-1W	G-2W
4	BR-1W	BR-2W
5	S-1W	S-2W
6	BL-1R	BL-2R

## 8. PRECAUTIONS

**8.01** When the cable has been kept in locations where the temperature is close to freezing, handle carefully and allow the cable to reach room temperature before using.



*Do not use friction tape to hold coil of wire together. Chemical reaction between friction tape and jacket of wire or cable may cause a stain.*

JACKS AND PLUGS

1. INTRODUCTION

1.01 This section covers the identification, installation, connections, and information on fasteners for jacks, and the termination of wire and cable thereon. It also includes the identification of plugs used with jacks.

1.02 Due to minor changes, marginal arrows are shown.

2. JACK AND PLUG SYSTEMS — REQUIREMENTS

2.01 Normally, one telephone equipped with a ringer is used in conjunction with a jack and plug arrangement. When the telephone arrangement is such that a ringer is not permanently connected to the line, a Test Line Termination consisting of a QHM4A Lamp Indicator is required as described in Section 501-250-900CA.

2.02 Hand telephone sets (those requiring a subscriber set) and combined telephone sets should not be used together in the same jack and plug system.

2.03 Jack mounting should be uniform so that plug insertions will be the same throughout the customer's premises.

3. JACKS AND PLUGS — IDENTIFICATION AND USE

3.01 Jacks and plugs permit one or more telephone sets to be used at one or more locations. They also permit the rapid disconnection

and reconnection of telephone service to ships, boats, trains, etc.

3.02 Table A provides information on the selection, identification, and use of plugs.

3.03 Table B provides information on the selection, identification, and use of jacks.

TABLE A

PLUGS

Principal Use	No. of Conductors	Type	Color	Plug Shown in Fig.
Portable Telephone Sets	4	283B	Gray-49 Ivory-50	1
	8	274A	Gray-49 Ivory-50	2
Fixed Locations for Ships, Boats, Trains, etc	3	KS-8419	Brass	10

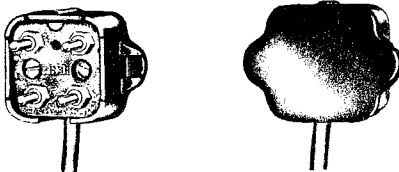


Fig. 1 — 283B Plug

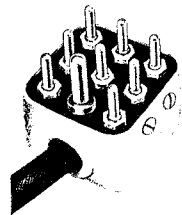


Fig. 2 — 274A Plug

TABLE B

## JACKS

Principal Use	Location	Type of Mounting		No. of Conductors	Type	Color	Jack Shown in Fig.	Furnished with	
								Quantity	Equipment
Portable Telephone Sets	Inside Buildings	Flush	Baseboard	4	493A	Gray-49 Ivory-50	4	2	Self-tapping Screws
			Outlet Box	4	497A	Gray-49 Ivory-50	3	1	493A Jack
		1						43-type Bracket	
		1						Coverplate	
		4						Metal Screws	
		Baseboard Outlet Box	8	391A	Gray-49 Ivory-50	5 7	1	Flush Coverplate	
							Mounting Screws		
									Washers
	Nonflush	4	404B	Gray-49 Ivory-50	12	2	Wood Screws		
							8	392A	Gray-49 Ivory-50
Patios, Terraces, Breezeways, Porches	Nonflush	4	KS-16151, List 1	Aluminum	15	1	493A Jack (Modified) Aluminum Housing with Hinged Cover		
							Flush	Coverplate	4
	Outlet Box	4	☐ T-11	Aluminum	11	1		Outlet Box	
	Fixed Locations for Ships, Boats, Wharves, Trains, etc	Outdoors at Ships, Boats, Wharves, Trains, etc	Flush		3	KS-8420	Brass	8	1
Nonflush			3	KS-8421	Brass	18	1	Cover	

☐ Not Bell Canada Standard

**4. JACKS AND PLUGS — TERMINATIONS AND CONNECTIONS**

**4.01** Connect only one wire or cable conductor to screw terminals of jacks.

**Jacks for Indoors and Patios — Connections**

**4.02** For 4-conductor jacks, connections should be as indicated by the color designations stamped adjacent to the terminals. The red conductor should be connected to the terminal designated R, etc.



Where jacks are used on 2-party selective, dial message-rate lines and at tip-party automatic ticketing stations, terminate the green conductor of station wiring on black terminal instead of on green terminal. A corresponding change is required in the associated plugs. This is required to prevent fraudulent use of the telephone.

- For all types of 8-conductor jacks, see Table C.

**TABLE C**

**CONNECTIONS FOR 8-CONDUCTOR JACKS**

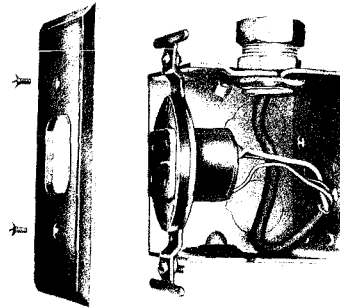
Inside Wire		C or D Inside Wiring Cable	Terminal Designations
1st Quad	Red	Blue	Red
	Green	White	Green
	Yellow	Orange	Yellow
	Black	White	Black
2nd Quad	Red	Green	White
	Green	White	Red-Red
	Yellow	Brown	Yellow-Yellow
	Black	White	Black-Black

**5. FLUSH-TYPE JACKS — INSTALLATION**

**5.01** The 391A, 493A and 497A jacks may be flush-mounted in outlet boxes, baseboards and panels. Fig. 3, 4, 5 and 7 show these mounting arrangements.

**5.02** The 497A jack in outlet box (Fig. 3) is mounted as follows:

1. Mount jack on 43A bracket with screws furnished.
2. Connect station wire to block, and dress as shown in Fig. 3.
3. Mount block-equipped bracket in outlet box with screws furnished.
4. Mount coverplate with screws furnished.

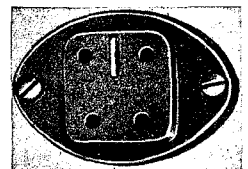


**Fig. 3 — 497A Jack Mounted in Outlet Box**

**5.03** The 493A jack is installed in baseboard or wall panel, as shown in Fig. 4, and as follows:

1. Place front side of jack against baseboard or other mounting surface at desired location.
2. Mark outline of jack on surface.
3. Drill a lead hole in the center of the marked jack outline.
4. Drill a hole for jack with a 1-1/4 inch station bit or equivalent, using lead hole.
5. Place jack in hole and mark locations for mounting screws.
6. Drill mounting holes.
7. Connect station wire to jack.
8. Fasten jack, using screws furnished with jack.

**Fig. 4 — 493A Jack Mounted in Baseboard**





SECTION 461-630-100CA

5.04 The 391A jack is installed in baseboard or wall panel, as shown in Fig. 5 and as follows:

1. Place coverplate against baseboard or other mounting surface at desired location.
2. Insert the point of a pencil through the coverplate screw holes and mark the centers of these holes on the supporting surface.
3. Measure from center of holes and draw rectangle as shown in Fig. 5.
4. Bore holes within the corners of the rectangle and remove material.
5. Connect station wire to jack.
6. Fasten jack to mounting surface with two 1/2 inch, FH bright wood screws.
7. Fasten coverplate with screws furnished with jack.

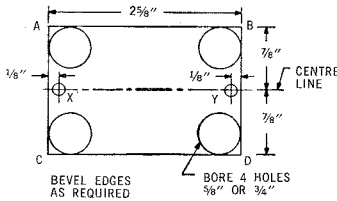


Fig. 5 — Method of Preparing Recess Hole for 391A Jack

5.05 This faceplate is used with 493A Type jacks, in homes with concealed wiring. →See section on concealed wiring for method of mounting.

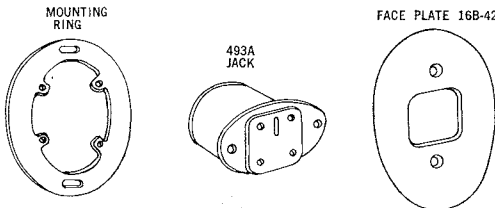


Fig. 6 — 16B Face Plate

5.06 The 391A jack in outlet box (Fig. 7) is mounted as follows:

1. Connect station wire to jack, and dress as shown in Fig. 7.
2. Mount jack in outlet box, using screws furnished with jack.
3. Fasten coverplate on jack, using screws furnished with jack.

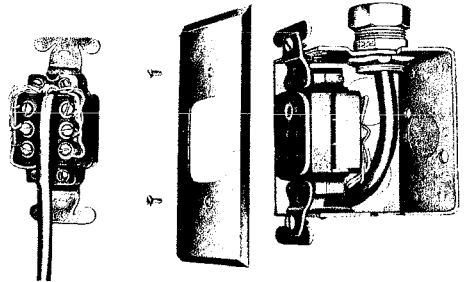


Fig. 7 — 391A Jack Unmounted and 391A Jack Mounted in Outlet Box

5.07 Install the KS-8420 jack at outdoor locations (for ships, boats, trains, etc) as follows (see Fig. 8) :

1. Arrange for a 2-11/16 inch hole at desired location.
2. Temporarily insert jack in hole and mark fastener holes.
3. Remove jack and drill fastener holes.
4. Connect wire as shown in Fig. 9.
5. Secure jack to mounting surface with four No. 8 RH brass wood screws or No. 8 RH brass machine screws.

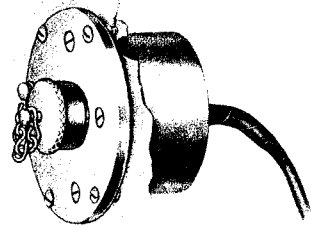


Fig. 8 — Installation of KS-8420 Jack

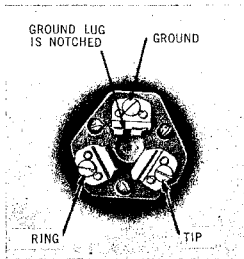


Fig. 9 — Connections for KS-8420 and KS-8421 Jacks

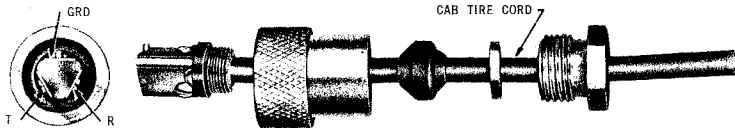


Fig. 10 — KS-8419 Plug

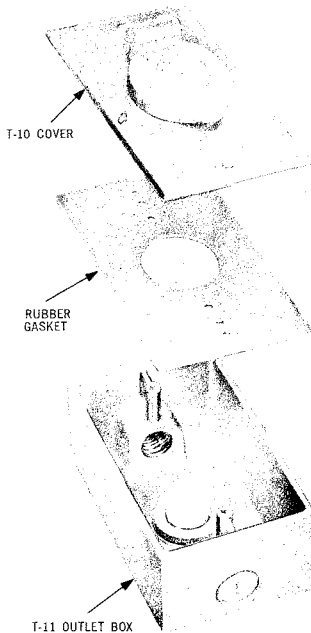


Fig. 11 — T-11 Outlet Box with T-10 Cover

- • Where a more rugged waterproof-type outlet box is required, a T-11 box may be used with a T-10 outlet cover.

**Outdoor Flush-type Jacks**

- 5.08 For outdoor flush-type jacks, the T-10 outlet cover and T-11 outlet box may be used.
- • Where a flush-type jack is desired in an outdoor location, the weatherproof T-10 telephone outlet cover may be used (see Fig. 11).

- • The T-10 outlet cover will fit any standard size outlet box and requires a 43A bracket to accommodate a 493A jack. The outer surface of both T-10 and T-11 have an aluminum finish.
- • The cover and box may be ordered as follows:
  - Cover, Perfect-Line Manufacturing Company, T-10 (includes faceplate, gasket, 43A bracket, and mounting screws)
  - Box, Perfect-Line Manufacturing Company, T-11

**6. NONFLUSH-TYPE JACKS — INSTALLATION**

- 6.01 Install 404B jack (Fig. 12) as follows:
1. Connect station wire to jack, and dress as shown in Fig. 12.
  2. Fasten jack to baseboard or other mounting surface, using screws furnished with jack.

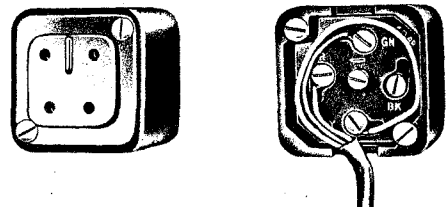


Fig. 12 — Installation of 404B Jack

SECTION 461-630-100CA

6.02 Install 392A jack (Fig. 13) as follows:

1. Connect station wire to jack, and dress as shown in Fig. 13.
2. Fasten jack to baseboard or other mounting surface.

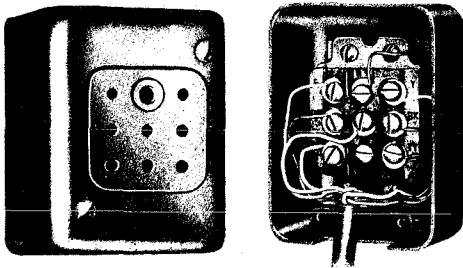
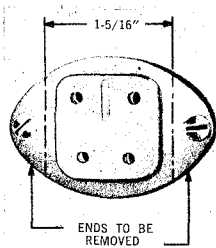


Fig. 13 — Installation of 392A Jack



▣ Fig. 14 — Modification of 493A Jack to Fit into KS-16151, List 1 Jack (See Note 2, Pg. 7)

▣ 6.03 The 493A jack (Fig. 14) may be modified to fit into the KS-16151, List 1 outdoor jack as follows:

1. Mark ends of jack as shown in Fig. 14.
2. Remove ends with hack saw.

6.04 Assemble and install the KS-16151, List 1 jack when used without conduit (Fig. 15 and 16) as follows:

1. Turn jack so that wire entrance hole faces downward.
2. Fasten jack housing with two fasteners (see Table D).
3. Run station wire through gland nut, friction washer, grommet, and through entrance hole into housing.
4. Connect wire to jack.
5. Assemble as shown, with hinge of cover at top of jack.

▣ Not Bell Canada Standard

6. If the cover spring should become inoperative, remove the bottom locking screw and replace the entire cover.

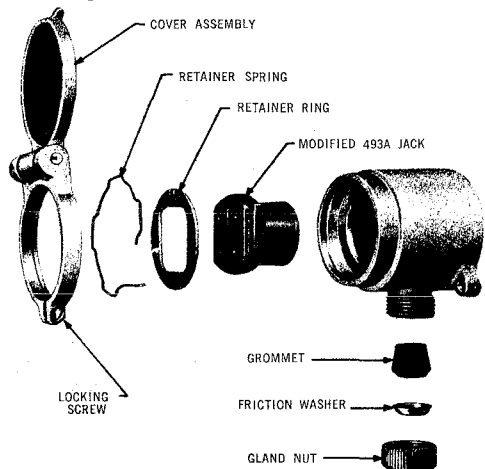


Fig. 15 — Assembly of KS-16151, List 1 Jack

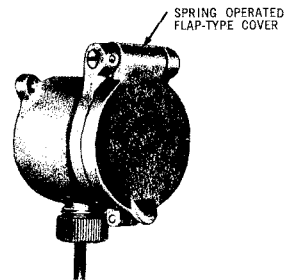
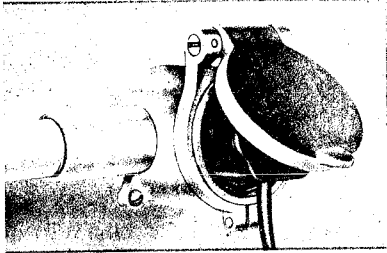


Fig. 16 — Typical Installation of KS-16151 Jack Installed without Conduit

6.05 Assemble and install the KS-16151, List 1 jack when used with 1/2-inch conduit (Fig. 17) as follows:

1. Screw threaded portion of jack housing into 1/2-inch conduit fitting. Screw other end of conduit fitting on conduit.
2. Fasten jack housing with two fasteners (see Table D).
3. Pull wire through conduit into fitting.
4. Connect wire to jack.
5. Assemble as shown, with hinge of cover at top of jack.

- If the cover spring should become inoperative, remove the bottom locking screw and replace the entire cover.



**Fig. 17 — Typical Installation of KS-16151 Jack Installed on 1/2-inch Conduit**

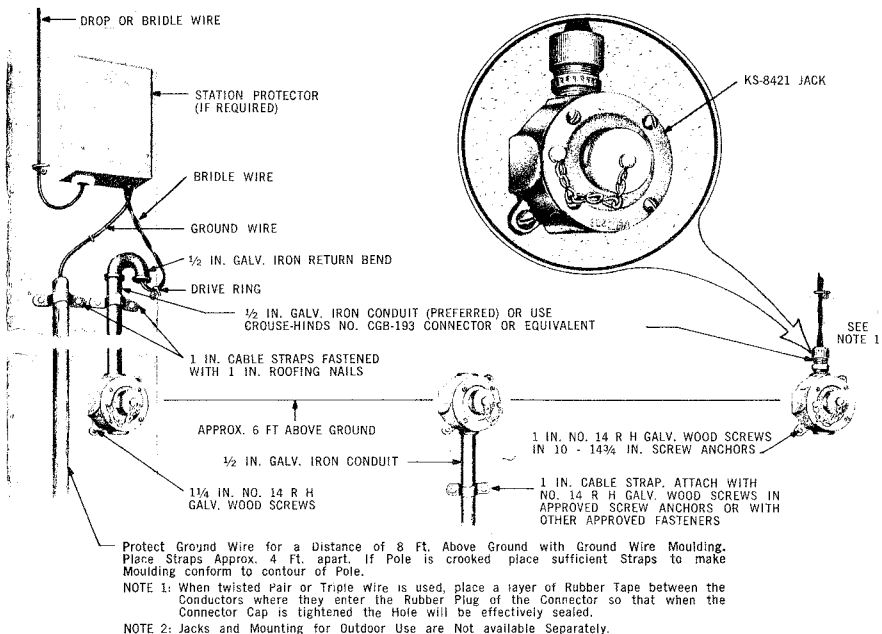
**TABLE D**

**FASTENING DEVICES FOR KS-16151, LIST 1 JACK**

Surface	Fasteners
Wood	1-1/4 in., No. 8 RH Galvanized Screws
Masonry	1-1/2 in., No. 6-8 Screw Anchor or equiv. and 2 in., No. 8 RH Galv. Screws
Hollow Tile	3/16 in. Toggle Bolts 4XL or 6S Wall Screw Anchor

- Install the KS-8421 jack (Fig. 18) as follows:

- Mount jack as shown in Fig. 18. Connect wire to jack.
- Fasten cover, using screws furnished with jack.



**Fig. 18 — Typical Installation of KS-8421 Jack**



**DROP AND BLOCK WIRING  
 SPLICING**

	CONTENTS	PAGE
1.	<b>GENERAL</b> . . . . .	179
2.	<b>NICOPRESS SLEEVES</b> . . . . .	179
3.	<b>USE OF THE 17BA NICOPRESS TOOL</b> . . . . .	179
4.	<b>SPLICING DROP WIRE TO DROP WIRE</b> . . . . .	180
5.	<b>SPLICING TWISTED PAIR WIRE TO TWISTED PAIR WIRE</b> . . . . .	182
6.	<b>SPLICING PARALLEL WIRE TO TWISTED PAIR WIRE</b> . . . . .	183
7.	<b>BRIDGING PARALLEL AND TWISTED PAIR WIRES</b> . . . . .	183

**1.04** For convenience in describing splicing procedures covered in these instructions, the wires to be spliced shall be referred to as Pair No. 1 and Pair No. 2.

**2. NICOPRESS SLEEVES**

**2.01** Nicopress sleeves are single-tube sleeves provided for use with the 17BA Nicopress Tool in splicing the insulated wires employed in drop and block wiring work. The types and sizes of sleeves for such work and the diameters of the conductors with which they are to be employed are shown in the following table:

Nicopress Sleeve

Type	Size Designation	Length (In.)	Wire Diameter (Mils)
Straight	32A	3/4 or 1-1/4	25 or 28
Straight	40B	1-1/4	40 or 45
Straight	64B	1-1/4	64
Combination	32 x 40B	1-1/4	25 or 28 to 40
Combination	40 x 64B	1-1/4	40 or 45 to 64
Split	40B*	3/4	25, 28 or 40 Bridge

**1. GENERAL**

**1.01** This section covers methods for splicing drop and block wires using nicopress sleeves.

**1.02** This section is revised to introduce the new method used in splicing NE drop wire.

**1.03** Observe the following general rules when splicing insulated drop and block wires.

- (a) Exercise care to avoid nicking the conductors when removing the insulation.
- (b) Thoroughly clean the skinned conductor ends before inserting into the nicopress sleeves.
- (c) Splice tracer conductor to tracer conductor and plain conductor to plain conductor.
- (d) When a splice is to be placed in a wire span, exercise care in splicing so as to equalize the tension in the conductors as near as practicable.
- (e) Thoroughly tape all splices.

**Note:** The letter in the size designation indicates the groove of the 17BA Nicopress Tool in which the sleeve is to be pressed. The smaller outside groove of the tool is designated A and the larger inside groove is designated B.

\*Press in the B groove of the tool in all cases, and then in the A groove when the conductor is 32 mils, or smaller.

**3. USE OF THE 17BA NICOPRESS TOOL**

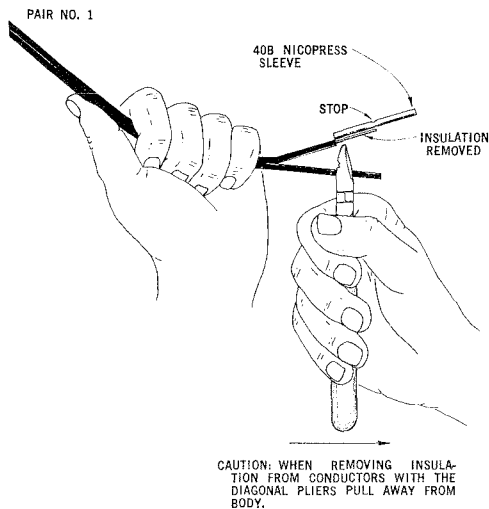
**3.01** The 17BA Nicopress Tool has been provided for pressing Nicopress sleeves. For the description, care and maintenance of the 17BA Nicopress Tool see Section 081-750-107.

3.02 The joint in the wires being joined is made by placing the Nicopress sleeve, into which the conductors have been inserted, into the proper groove of the tool and pressing the handles until the jaws are brought together. This is repeated at a specified number of points along the length of the sleeve.

4. SPlicing DROP WIRE TO DROP WIRE

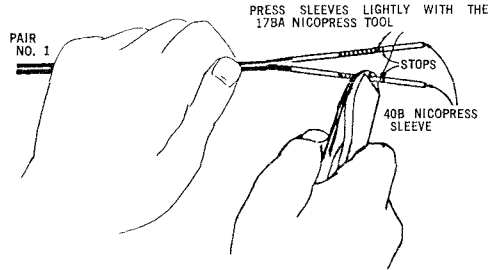
4.01 Splice NE drop wire as follows:

- (1) Prepare NE drop wire for splicing as outlined in 462-030-100. Separate the conductors for approximately 1½ inches.
- (2) Remove the jacket and insulation from both conductors of Pair No. 1 for a distance of half the length of a Nicopress sleeve, as illustrated below, exercising care not to nick the conductors. Make sure that the ends of the insulation on the conductors are even. Clean the skinned conductors with either diagonal pliers or abrasive cloth.

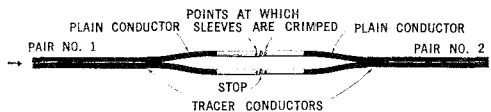


(3) Treat the conductors of Pair No. 2 as described for Pair No. 1 in (1) and (2).

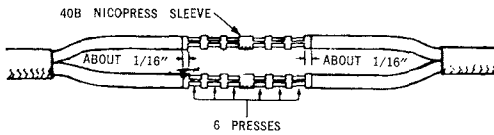
(4) Slip a 40B Nicopress sleeve over each skinned conductor of Pair No. 1 up to the indentation in the sleeve. Crimp each sleeve lightly near midpoint to keep it from slipping off.



(5) Match tracer conductors and insert conductors of Pair No. 2 into the sleeves on conductors of Pair No. 1 up to the indentation in the sleeve. Crimp the sleeves lightly with the 17BA Nicopress Tool to hold Pair No. 2 in place. (See below)



(6) Starting over the light presses made in (4) and (5) above and ending approximately 1/16 in. from the end of the sleeve, press each sleeve six times in the larger groove of the Nicopress 17BA tool. One-half of the total number of presses should be made at equidistant intervals on each side of the indentation at the mid-point of the sleeve as shown in the following illustration. The pressing operations are facilitated if, after each press, the handles of the 17BA tool are opened only sufficiently to slide the tool to the location of the next press.



(7) Straighten the spliced conductors and determine whether they are of equal length. If one conductor is shorter than the other, lengthen it by pressing one or more of the unpressed portions of the sleeve, which are shown in the previous illustration, until equalization is obtained.

(8) Place a splice Separator between the two sleeves, and wrap both the sleeves and the separator with two half-lapped layers of 3/4" DR Tape starting and ending at the centre. The DR Tape should overlap the jacket one inch at each end.

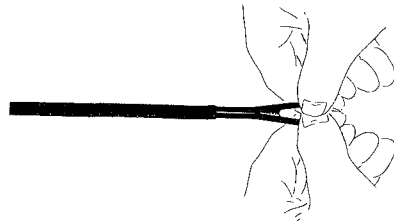
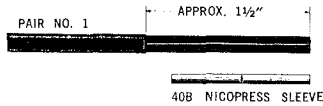


(9) Cover the DR Tape with two half-lapped layers of 3/4" black friction tape.



**4.02 Splice NC drop wire as follows:**

(1) Strip the outside covering from the end of Pair No. 1 for a length of about 1 1/2 inches with a braid stripper, as illustrated in 462-030-100. Separate the insulated conductors as shown below.



(2) Remove insulation from both conductors of Pair No. 1 for a distance of half the length of a 40B Nicopress sleeve as illustrated in Para. 4.01 exercising care not to nick the conductors. Make sure that the ends of the insulation on the conductors are even. Clean the skinned conductors with either diagonal or abrasive cloth.

(3) Slip a 40B Nicopress sleeve over each skinned conductor of Pair No. 1 up to the indentation in the sleeve. Crimp each sleeve lightly near midpoint to keep it from slipping off.

(4) Treat the conductors of Pair No. 2 as described for Pair No. 1 in (1) and (2).

(5) To complete the splice for NC drop wire, proceed as described and illustrated in Paras. 4.01 (5) through (9).



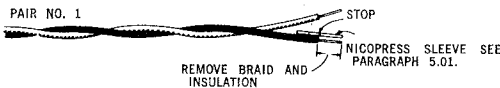
**5. SPLICING TWISTED PAIR WIRE TO TWISTED PAIR WIRE**

**5.01** Use the following Nicopress Sleeves in splicing the types of twisted wires indicated:

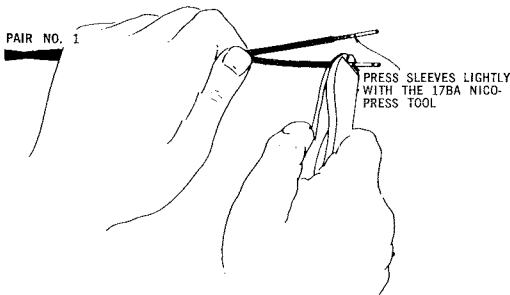
Type of Wire	Nicopress Sleeve
Block Wire	32A
HD Drop Wire	64B

**5.02** Splice twisted pair drop wire to twisted pair drop wire as follows:

- (1) Remove the jacket and insulation from both conductors of Pair No. 1 for a distance equal to one-half the length of the proper size Nicopress sleeve as illustrated, exercising care not to nick the conductors. Clean the conductors thoroughly, using either Diagonal Pliers or abrasive cloth. Make sure that the ends of the jacket and insulation and also the ends of the conductors are even.

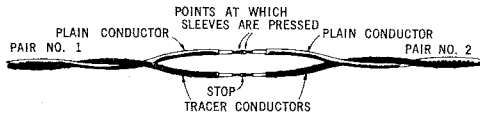


- (2) Place a Nicopress sleeve of the proper size on each conductor of Pair No. 1, with the ends of the sleeves touching the insulation, and press each sleeve lightly with the 17BA Nicopress Tool as illustrated, to hold them in place.



- (3) Remove the jacket and insulation from the conductors of Pair No. 2 as described in (1).
- (4) Matching the tracer conductors, insert the conductors of Pair No. 2 into the sleeves on the conductors of Pair No. 1 so that the insulation touches the ends of the sleeves. Press

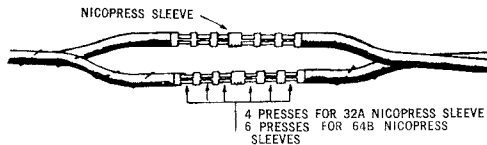
each sleeve lightly with the 17BA Nicopress Tool as illustrated, to hold the conductors of Pair No. 2 in place.



- (5) Starting over the light presses made in (2) and (4) above and ending approximately 1/16 in. from the end of the sleeve, press each sleeve the number of times and in the groove of the 17BA Nicopress Tool specified in the following table.

Size of Sleeve	Size of Groove in 17BA Nicopress Tool	Number of Presses
32A	Small	4
64B	Large	6

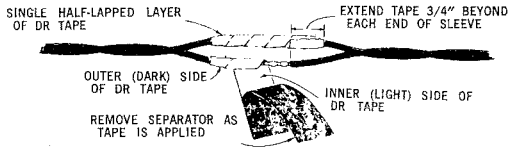
One-half of the total number of presses should be made at equidistant intervals on each side of the indentation at the mid-point of the sleeve as shown in the following illustration. The pressing operations are facilitated if, after each press, the handles of the 17BA Nicopress Tool are opened only sufficiently to slide the tool to the location of the next press. Exercise care in pressing 32A Nicopress Sleeves and in disengaging the 17BA Nicopress Tool from these sleeves to avoid bending the conductors at the ends of the sleeves.



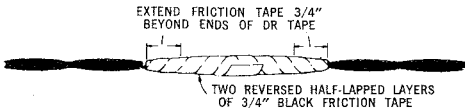
- (6) Straighten the spliced conductors and determine whether they are of equal length. If one conductor is shorter than the other, lengthen it by pressing one or more of the unpressed portions of the sleeve, which are shown in the previous illustration, until equalization is obtained.

- (7) Wrap each joint with a single half-lapped layer of DR Tape as illustrated. A piece of DR Tape approximately 2-1/2 in. long is required for wrapping the 32A Nicopress Sleeve and one approximately 4 in. long for wrapping

the 64B Nicopress Sleeve. Apply the tape under a slight tension, which will about double its original length, and remove the separator as the taping progresses. Press the taped joint firmly between the fingers to cement the layers of the tape together.



(8) Wrap the entire splice with two reversed half-lapped layers of  $\frac{3}{4}$  in. Black Friction Tape as illustrated. Starting at the centre of the splice, wrap to  $\frac{3}{4}$  in. beyond one end of the rubber tape, reverse, wrap to  $\frac{3}{4}$  in. beyond the other end of the rubber tape, reverse, and end the wrapping at the centre of the splice.



**6. SPLICING PARALLEL WIRE TO TWISTED PAIR WIRE**

**CAUTION:** Splice block wire only to unexposed drop wire or to drop wire on the station side of a fuseless protector.

**6.01** Use the following Nicopress combination sleeves in splicing the types of Wire indicated:

Types of Wires to be Joined	Combination Nicopress Sleeve
NE or NC Drop Wire to Block Wire	32 x 40B
NE or NC Drop Wire to HD Drop Wire	40 x 64B

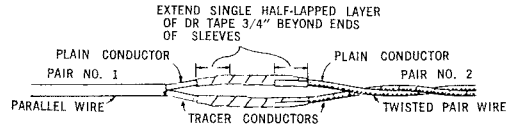
**6.02** Splice parallel drop wire to twisted pair drop wire as follows:

(1) Prepare the parallel wire (Pair No. 1) and the twisted pair wire (Pair No. 2) splice the conductors of these wires, and apply DR Tape to the joints as outlined in Paras. 4.01 (1 to 8) and Paras. 5.02 (1 to 7), respectively. Press each sleeve the number of times

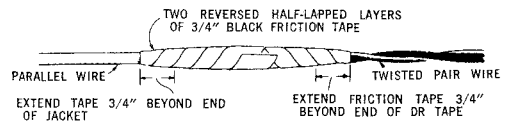
and in the groove of the 17BA Nicopress Tool specified in the following table:

Size of Sleeve	Size of Groove in 17BA Nicopress Tool	Number of Presses
32 x 40B	Large	4
40 x 64B	Large	6

The appearance of the splice upon completion of these operations is shown in the following illustration.



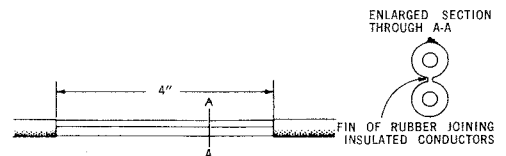
(2) Wrap the entire splice with two reversed half-lapped layers of  $\frac{3}{4}$  in. Black Friction Tape as illustrated. Starting at the center of the splice, wrap to  $\frac{3}{4}$  in. beyond the end of the rubber tape toward the twisted pair wire, reverse, wrap to  $\frac{3}{4}$  in. beyond the end of the parallel wire braid, reverse, and end the wrapping at the center of the splice.



**7. BRIDGING PARALLEL AND TWISTED PAIR WIRES**

**7.01** Using the 40B Split Nicopress Sleeve, bridge parallel Drop Wire to parallel drop wire or Block Wire as follows:-

(1) Remove approximately 4 in. of jacket from the through parallel drop wire, using a Braid Stripper. Exercise care not to damage the rubber insulation of the conductors.

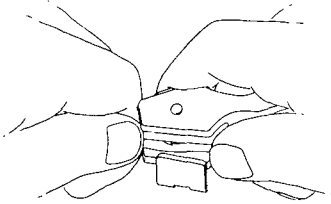


(2) Where the insulation of the two conductors is joined by a fin of rubber, cut through the fin by means of the Braid Stripper as outlined, exercising care not to damage the

**SECTION 462-200-200CA**

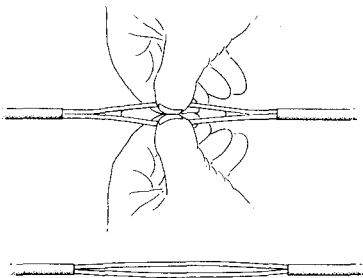
insulation. Keeping the Drop Wire under tension facilitates this operation.

- (a) Lay wire in groove of Braid Stripper which is normally used for cutting the jacket of Multiple Drop Wire, keeping the guard raised in order that the wire may be visible during the cutting operation. Center wire over blade so that when a slight pressure is applied upward on Braid Stripper the blade can be distinguished between the conductors.

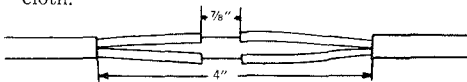


- (b) With blade in position between conductors, increase upward pressure on Braid Stripper and slowly draw it along the wire until blade has cut approximately 1/2 in. of the fin.

- (c) Remove Braid Stripper and separate the conductors by hand for the remaining length.



- (3) Midway between the ends of the jacket remove the insulation from each conductor for a length of 7/8 in., exercising care not to nick the conductors. Clean the conductors thoroughly using Diagonal Pliers or abrasive cloth.

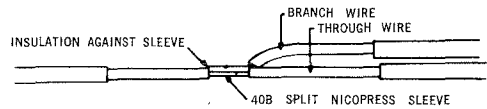


- (4) Cut evenly the end of the Drop Wire or Block Wire which is to be bridged to the through parallel drop wire.

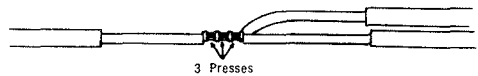
- (5) From the parallel drop wire which is to be bridged remove approximately 2 1/2 in. of jacket, separate the conductors and remove approximately 3/4 in. of insulation in a similar manner to that set forth in Para. 4.01 (1) and (2).

- (6) When Bridle Wire is to be bridged to the through parallel drop wire, remove approximately 3/4 in. of jacket and insulation from the conductors in a similar manner to that set forth in Para. 5.02 (1).

- (7) Place a 40B Split Nicopress Sleeve on each of the bare conductors of the through wire. Match plain and tracer conductors of the through and branch wire runs. Turn one of the split sleeves on the through conductor so the split is at the side. Then lift the sleeve so the through conductor is at the bottom of the elliptical bore. Insert the branch conductor in the upper part of the bore. Repeat these operations with the other conductor of the through and branch wire runs.



- (8) With the split in the sleeve toward the tool, press the sleeve three times in the large groove of a 17BA Nicopress Tool.



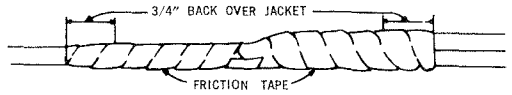
- (9) Cover each joint completely with a single half-lapped layer of DR Tape and extend the tape over the insulation of the through conductor at each end of the joint for 3/4 in. Cover the insulation of the branch conductor with a second strip of DR Tape of 3/4 in. starting at the far end of the split sleeve.



(10) Wrap the completed splice with two half-lapped layers of  $\frac{3}{4}$  in. Black Friction Tape as shown. Starting at the centre of the splice, wrap to  $\frac{3}{4}$  in. beyond one end of the jacket, reverse, wrap to  $\frac{3}{4}$  in. beyond the end of the jacket at the other end of the splice, reverse, and end the wrapping at the centre of the splice.

**7.02** Proceed similarly when bridging Block Wire to Block Wire, except that the jacket

of the through wire is to be removed for only the same  $\frac{7}{8}$  in. as the insulation and the 40B Split Nicopress Sleeve must be pressed in the small groove of the 17BA Nicopress Tool *after* pressing in the large groove.





## DROP AND BLOCK WIRING

### DROPS FROM OPEN AND RURAL WIRE LINES

#### 1. GENERAL

- 1.01** This section covers methods of bridling to open wire.
- 1.02** This information was formerly covered in Section 625-240-200CA (G32.129.1) which is canceled.
- 1.03** Fuseless protectors for stations will be specified by service orders or other local instructions.

#### 2. DISTRIBUTING DROPS FROM OPEN WIRE LINES

- 2.01** Distribute drops from a drive hook in the pole if climbing space, joint use, and ground clearances permit, and there is adequate clearance between the drops and existing or future open wires. Otherwise distribute drops from crossarms as outlined in 2.02.
- 2.02** Distribute drops from crossarms as follows:
- (a) Crossarms Other Than DE Type: Distribute from a drop wire hook where not more than two drops will be run from the same point on the crossarm. Distribute from a guard arm hook where more than two drops will be run. Not more than five drops shall be attached to one guard arm hook.
- (b) DE Crossarm: Distribute drops from drop wire hooks attached to the sides of the crossarm.

#### 3. INSTALLING DROP WIRE AND GUARD ARM HOOKS ON CROSSARMS

- 3.01** Attach drop wire hook to crossarm with a 1-1/2 inch No. 18 RH galvanized wood screw. On a crossarm equipped with insulator pins, center the hook on side of crossarm and between pins as covered in 4.10 or closer to the pole if adequate clearances can be obtained and climbing space is not obstructed. On a crossarm on which the open wires are terminated on dead-end brackets, locate the hook midway between

the two outer bracket positions and 1-1/8 inches above bottom of crossarm. Shift location of hook as necessary to avoid checks or cracks in crossarm. Drill lead hole for the No. 18 wood screw with an 11/64-inch drill point.

- 3.02** Place guard arm hook in a 9/16- or 5/8-inch clearance hole drilled in the side of the crossarm (3-1/4 inches thick). Center the hole between top and bottom of the arm and between pins or closer to the pole if adequate clearances can be obtained and climbing space is not obstructed.

#### 4. WIRING AT CROSSARMS AND POLES

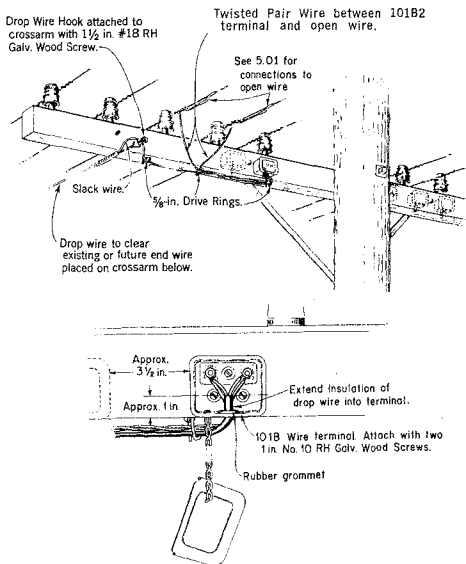
##### General

- 4.01** Terminate parallel drop wire at a 101B2 wire terminal and run twisted pair wire between the terminal and the open wire. Follow this method when making new installations, re-installations, rearrangements, and repairs.
- 4.02** If the drop is run with HD wire, the 101B2 wire terminal is not required, as this wire may be connected directly to the open wire.
- 4.03** Locate the 101B2 terminal on pole side of crossarm with lower edge  $\frac{3}{4}$  inch above bottom of crossarm. Locate the first terminal to be placed between the first and second wires from the pole so that it will be readily accessible. Space additional terminals  $2\frac{1}{2}$  inches apart on other crossarms.

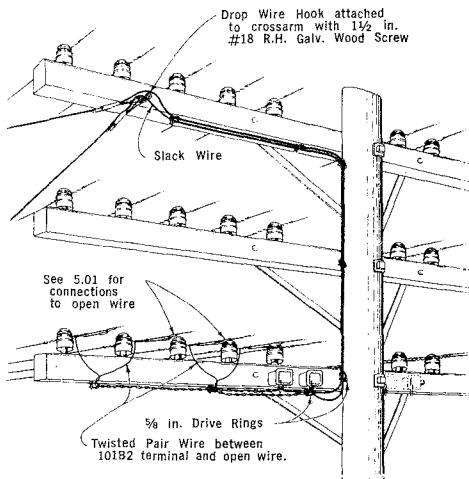
*Note:* To avoid splicing out parallel drop wires installed prior to placing the 101B2 terminal or to comply with distances specified in Part 7, the terminal may be located between any pin positions.

- 4.04** The binding posts of the 101B2 terminal will accommodate three parallel drop wires and the bridle wire to the open wire. (The superseded 101B terminal will accommodate the same number of drop wires).

**SECTION 462-240-200CA**



**Fig. 1 – Where Drop Wire Is Distributed from Crossarms Other than DE Type**



**Fig. 2 – Where Drop Wire Is Distributed from a Higher Crossarm on a Pole**

**4.05** Terminate twisted pair wire under the bottom washers on the binding posts, and the first parallel drop wire between the second and third washers and so on.

**4.06** If four drop wires are to be bridged to the same open wire, install two 101B2 terminals and bridle from each terminal to separate bridging sleeves or bridging connectors spaced approximately 2 inches apart on the open wire.

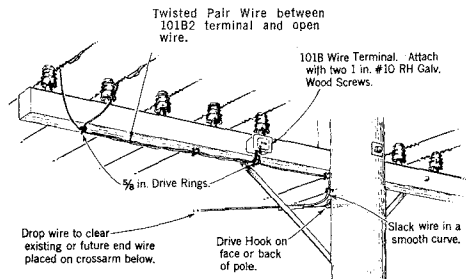
**4.07** Install 5/8 inch drive rings on underside of crossarm near the point where the drop is attached and at points where wires extend to the open wire at the 101B2 terminals. Install additional rings as required to limit ring spacings to approximately 20 inches.

**4.08** Use B bridle wire for bridling between 101B2 terminals and open wire except where the use of block wire is specified as in Part 7 or by local instructions. Use bridging sleeves or bridging connectors for connection to open wire.

**4.09** At double crossarms equipped with insulator pins follow the general wiring method specified for single crossarms, locating the 101B2 terminal preferably on the side of the crossarm toward the bridging sleeves or bridging connectors. Locate the wire run on the underside of the same crossarm.

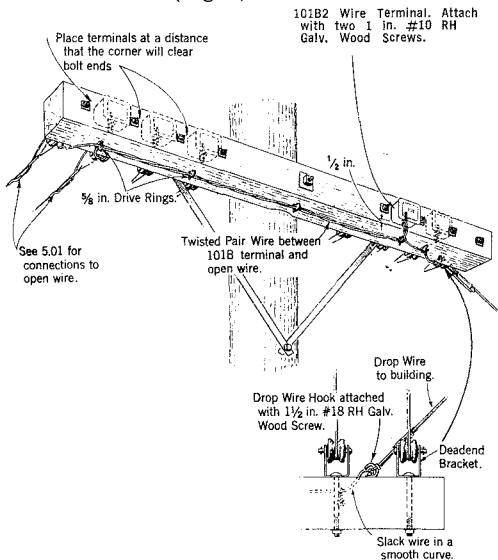
**Crossarms Equipped with Insulator Pins**

**4.10** The wiring arrangement on crossarms equipped with insulator pins is illustrated in Fig. 1, 2, and 3.



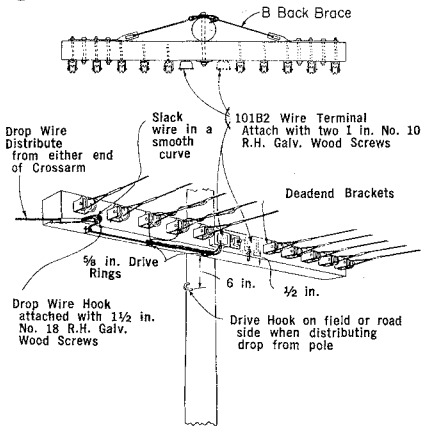
**Fig. 3 – Where Drop Wire Is Distributed from a Pole**

**4.11 Crossarms Equipped with Deadend Brackets (Fig. 4).**

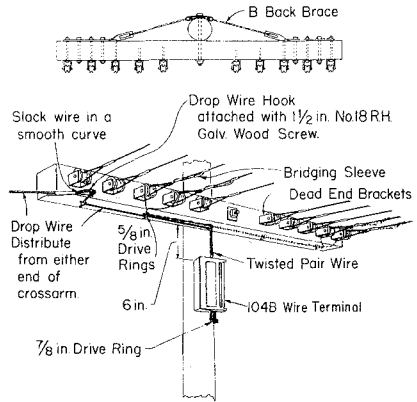


**Fig. 4 – Wiring Arrangement on DE Crossarms Not Having Back Braces**

**4.12 The wiring arrangement on DE crossarms equipped with back braces is illustrated in Fig. 5 and 6.**



**Fig. 5 – For Not More than Two Drops Use 101B Wire Terminals Placed on Line Wire Side of Crossarm**

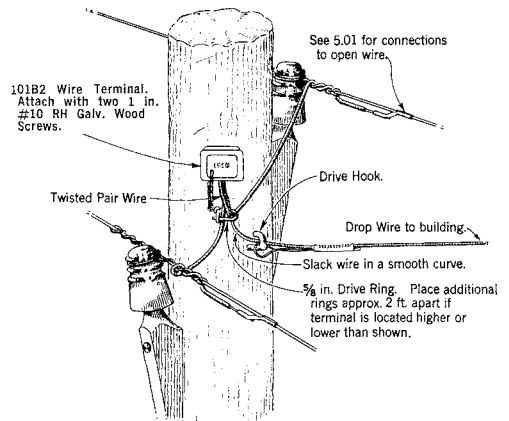


**Fig. 6 – For More than Two Drops Use a 104B Wire Terminal Mounted on Pole 6 Inches Below Arm**

**4.13 At double crossarms equipped with dead-end brackets, follow the general wiring method shown in Fig. 4, locating the 101B2 terminal on the outer side of the crossarm not equipped with deadend brackets. Locate the wire end run on the underside of the same crossarm.**

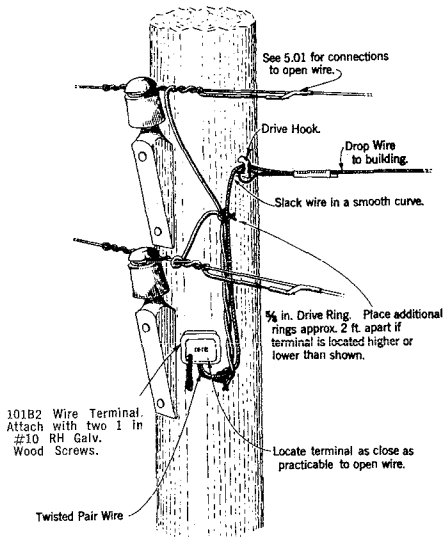
**Poles Equipped with Wooden Pole Brackets**

**4.14 The wiring arrangements on line poles equipped with wooden pole brackets are illustrated in Fig. 7 and 8.**



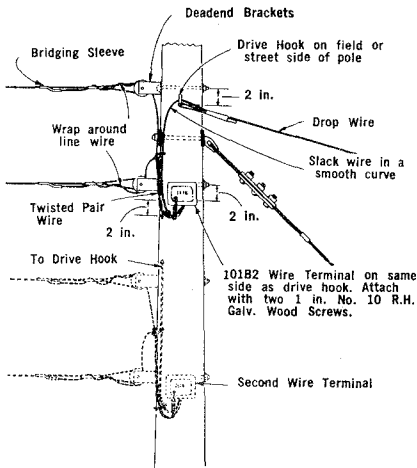
**Fig. 7 – Where Pole Brackets Are Located on Opposite Sides of Pole**





**Fig. 8 – Where Pole Brackets Are Located on Same Side of Pole**

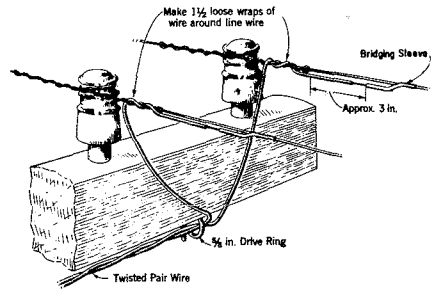
**4.15 Poles Equipped with Deadend Brackets (Fig. 9)**



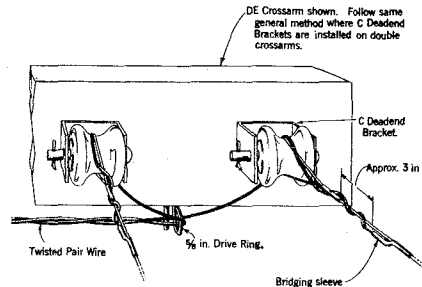
**Fig. 9 – Where Lines Are Terminated on Deadend Brackets Attached to Face or Back of a Pole**

**5. CONNECTING TWISTED PAIR WIRE TO OPEN WIRE**

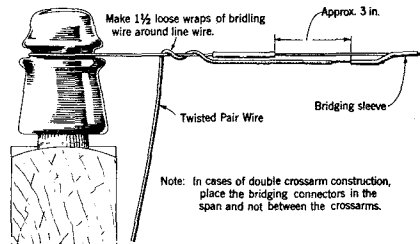
**5.01** In general, connect twisted pair wire to open wire attached to glass insulators or deadend brackets as illustrated in Fig. 10, 11, and 12.



**Fig. 10 – Where Line Wires Are Tied to Pin-Type Insulators**



**Fig. 11 – Where Line Wires Are Terminated on Deadend Brackets**



**Fig. 12 – Where Line Wires Are Terminated on Pin-Type Insulators**

**5.02** Connect bridle wire to tree wire, using one of the methods covered for bare line wire, depending on the exposure conditions involved. Remove sufficient insulation from the tree wire to permit making the connection as specified for bare line wire.

**6. INSTALLATION OF WIRE VIBRATION DAMPER**

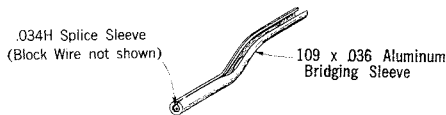
**6.01** Install vibration dampers as covered in Section 623-030-103CA where open wires vibrate to such an extent as to cause breakage of twisted pair wires at bridging points or to produce a vibration noise at a building to which a drop wire is attached.

**7. BRIDLING WHEN FUSELESS PROTECTORS ARE USED AT STATION**

**7.01** Where stations served from open wire or rural wire will use the fuseless protector, 123A1A, a length of Z block wire not less than

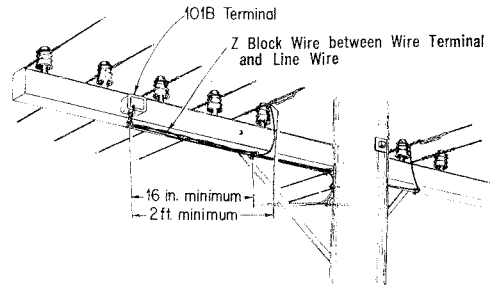
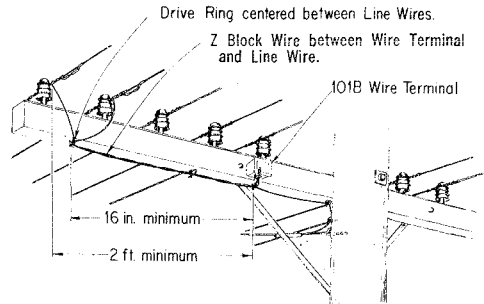
2 feet shall be used between the drop wire and open or rural wire in accordance with the examples in Fig. 13 through 17. Bridging to 109 size steel wire or 104 size copper steel wire may be made with a 109 x 036 Galvanized Bridging Sleeve.

Note: Z Block Wire shall have at least one right angle bend in it.

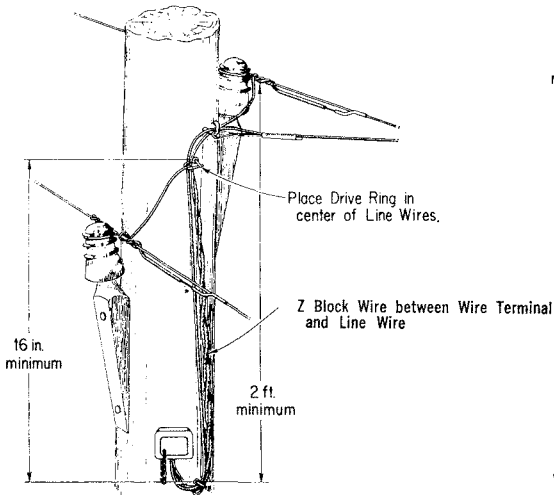


- Note: 1. Crimp H Splice Sleeve to D Block Wire with Sleeve Pressing Tool, and flatten ridges.  
 2. Insert .034H Splice Sleeve with D Block Wire in 109 x 109 B Aluminum Bridging Sleeve.  
 3. Crimp Bridging Sleeve with Q Groove of QC Nicopress Tool.  
Do Not Use Sleeve Rolling Tool

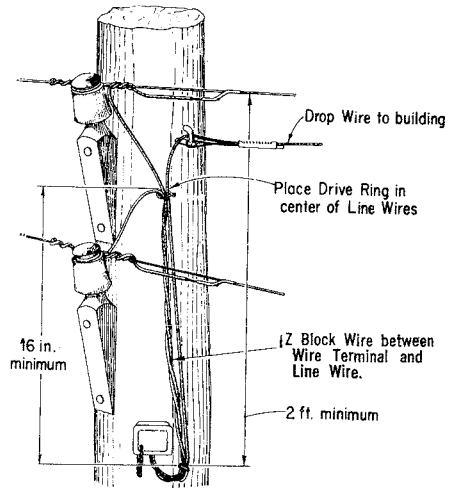
**Fig. 13 — B Aluminum Bridging Sleeve**



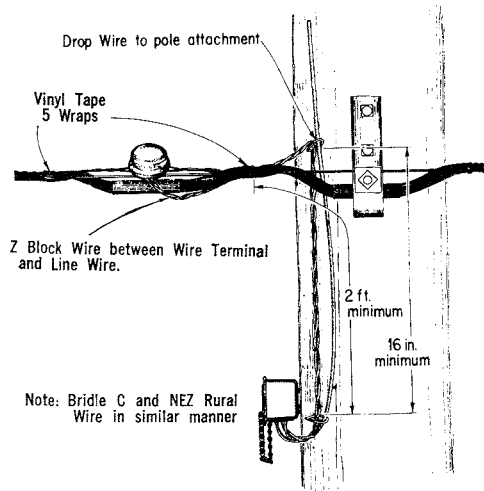
**Fig. 14 — Open Wire on Crossarm**



**Fig. 15 — Open Wire on Brackets, Same Side of Pole**



**Fig. 16 — Open Wire on Brackets**



**Fig. 17**

## DROP AND BLOCK WIRING

### POLE AND GUARD ARM ATTACHMENTS

#### 1. GENERAL

**1.01** This section covers methods of installing the drive hook, guard arm, and guard arm hook, and of running drop wires from guard arms.

**1.02** This section is reissued to revise Fig. 1.

#### 2. LOCATING DRIVE HOOK

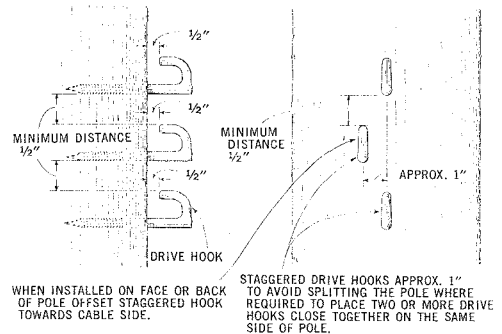
**2.01** Locate drive hook on pole preferably below the strand where drop wires can be placed with proper clearances above ground and from foreign wires and trees. This applies particularly to runs from span clamps and pole-to-pole runs in order to avoid whipping of the drop wire against strand and cable.

**2.02** Locate drive hook above the strand where necessary to provide proper clearances. The distance from the strand to the drive hook may be varied to meet the conditions encountered, observing joint use clearances.

**2.03** Drive hooks may be located both above and below the strand on the same pole where necessary to meet the conditions involved. They may also be located on the cable side as well as on the face or back of the same pole, provided unobstructed climbing space is maintained on jointly used poles.

#### 3. INSTALLING DRIVE HOOK

**3.01** Hold the drive hook with one hand until it is driven well into the pole in order to prevent it from being dislodged when struck with the hammer. When placing more than one drive hook on the same side of the pole stagger the hooks as shown in Fig. 1. Try to obtain greater than the minimum vertical separation between hooks, particularly for paralleling drops.



**Fig. 1 — Drive Hooks Installed in Pole**

**3.02** If the diameter of the pole is less than 5 inches, a 5/16-inch lead hole, approximately 3 inches deep, shall be provided for the drive hook to avoid splitting the pole, particularly if the hook is installed near the top of the pole. On such poles, a vertical separation of about 3 inches shall be provided between drive hooks installed on opposite sides of the pole. A lead hole shall also be provided where difficulty is experienced in driving the hook into hard poles. Drill the lead hole with a 5/16-inch by 7-1/2 inch installer drill in a bit brace or with a 5/16-inch masonry drill in a drill holder.

#### 4. CAPACITY OF DRIVE HOOK

##### General

**4.01** The maximum number of drop wires that may be attached to one drive hook varies according to the directions of the spans and the available space on the hook.

**Note:** If a drop wire spans in two directions from a drive hook placed in the face or back of the pole, the number of attachments that may be made to one drive hook is expressed as the number of spans instead of the number of wires.

**Drive Hook Installed in Face or Back of Pole**

4.02 Where the drive hook is installed in the face or back of the pole the maximum number of spans (not wires) that may be attached to the same drive hook is shown in Table A.

**TABLE A**

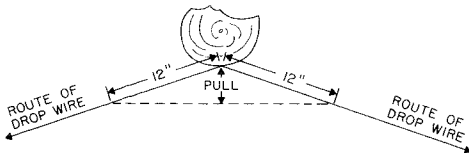
MAXIMUM ALLOWABLE NUMBER OF SPANS (NOT WIRES) FROM A SINGLE DRIVE HOOK INSTALLED IN FACE OR BACK OF POLE				
DIRECTIONS OF SPANS	Paralleling Pole Line	Crossing Highway	Not Crossing Highway	Total Allowable
MAXIMUM NUMBER OF SPANS	0	3	4	7
	1	2	3	6
	2	1	2	5
	3	0	0	3

*Example:* By reading across the table, a maximum of two spans paralleling the pole line, one span crossing the highway, and two spans not crossing the highway may be attached to the same drive hook.

**Drive Hook Installed in Cable Side of Pole**

4.03 In runs along the lead, the maximum number of wires (not spans) that may be attached to a drive hook installed in the cable side of the pole is four in cases where there is no pull on the pole, where the pull is against the pole, or where the pull away from the pole is 4 inches or less as defined in Fig. 2. Where the pull away from the pole is more than four inches, the maximum number is three drop wires.

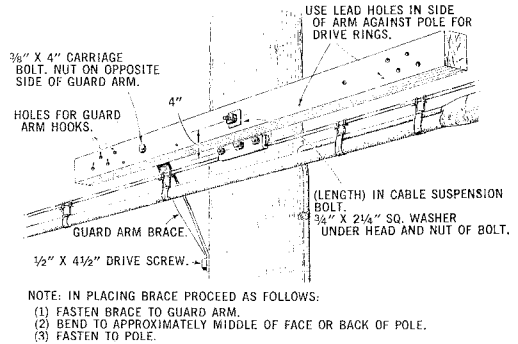
4.04 A maximum of four drop wires from span clamps may be attached to a drive hook installed in cable side of a terminal pole.



**Fig. 2 — Showing Pull on Pole**

**5. INSTALLING GUARD ARM**

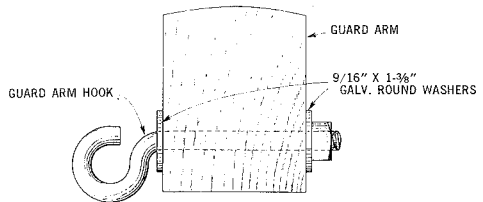
5.01 Install guard arm as shown in Fig. 3.



**Fig. 3 — Guard Arm Installed**

**6. INSTALLING GUARD ARM HOOK**

6.01 The guard arm hook is used in connection with attaching drop wires to guard arms and to crossarms other than the DE type. At a guard arm, install hook in one of the holes provided at the ends of the arm, following the order covered in Para. 8.01. At a crossarm, it is necessary to bore a 9/16- or 5/8-inch hole for each hook. Locate the hole as covered in Section 462-240-200CA. (See Fig. 4.)



**Fig. 4 — Guard Arm Hook Installed**

6.02 Use the drop wire hook instead of the guard arm hook on the DE crossarm. The drop wire hook should also be used instead of the guard arm hook on crossarms other than the DE type, except where more than two drop wires must be attached to the same hook or where a clearance hole is provided in the crossarm for a guard arm hook. Install drop wire hook on crossarm as covered in Section 462-240-200CA.

**7. CAPACITY OF GUARD ARM HOOK**

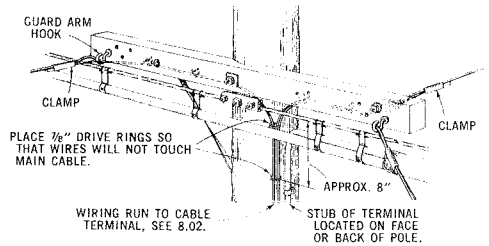
**7.01** A total of five drop wires, in any direction, may be attached to one guard arm hook.

**8. RUNS FROM GUARD ARM**

**Distributing from Guard Arm to Building**

**8.01** Distribute drop wires from a guard arm as shown in Fig. 5 and 6.

**8.02** Attach drop wire clamp to guard arm hook by passing wire tail of clamp over hook. Pass drop wires through the hook unless the hook is congested. Run wires on guard arm and pole in a neat manner with sufficient slack so that there will be no strain or sharp bends at rings, hooks, and clamps.



**Fig. 6 – Cable Terminal Mounted on Face or Back of Pole**

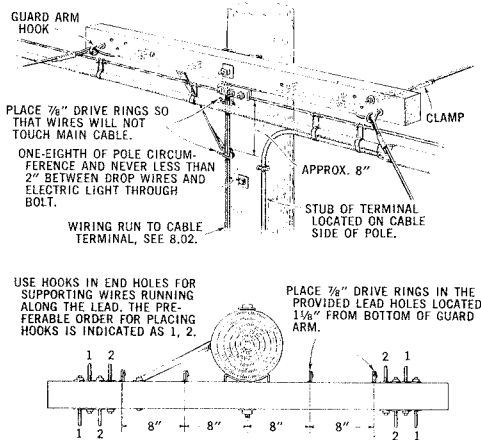
**8.03** Where brackets and knobs previously installed on guard arm are in a servicable condition, drop wires may be distributed from vacant grooves of the knobs. Not more than one drop shall be attached to an S Knob.

**Balancing Load on Guard Arm**

**8.04** When installing or rearranging drop wires, it may be necessary to place and distribute from a new guard arm hook at the opposite end of the guard arm instead of using an existing hook, in order to balance the load.

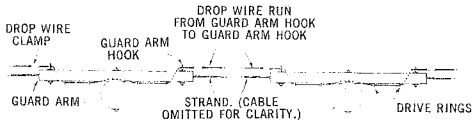
**8.05** When removing dead drops, the arrangement of the remaining drops may cause excessive strain on one end of the guard arm. Rearrange the drops in so far as practicable to equalize the strain, such as by moving drops from one guard hook arm to another.

**8.06** When a number of drops are attached to the same building, it may be desirable to distribute from both ends of the guard arm in order to equalize the strain, provided that the required climbing space will not be obstructed.

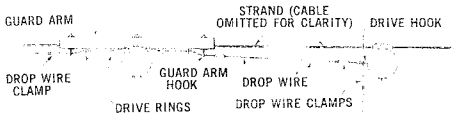


**Fig. 5 – Cable Terminal Mounted on Cable Side of Pole**

**SECTION 462-300-200CA**



**Fig. 7 — Drop Wire Run Along Lead from Guard Arm to Guard Arm**

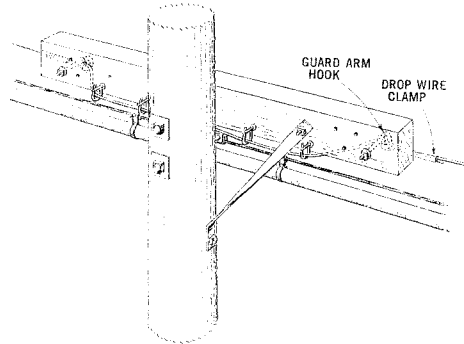


**Fig. 8 — Drop Wire Run Along Lead from Guard Arm to Pole**

**Guard Arm-to-Guard Arm Run**

8.07 When it is necessary to run along the lead from guard arm to guard arm or from

guard arm to pole, dead-end both ways using drop wire clamps as illustrated in Fig. 7, 8, and 9.

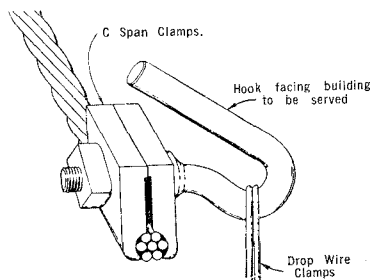


**Fig. 9 — Wiring at Intermediate Guard Arm for Run along the Lead**

## DROP AND BLOCK WIRING STRAND ATTACHMENTS

	CONTENTS	PAGE
1.	GENERAL . . . . .	197
2.	PLACING C SPAN CLAMP ON SUSPENSION STRAND OF LASHED AND RING SUPPORTED CABLE . . . . .	197
3.	RUNNING DROP WIRE FROM C SPAN CLAMP TO POLE . . . . .	197

**C Span Clamp on Strand  
 (Cable omitted for clarity)**



**1. GENERAL**

**1.01** This section covers the installation of the C Span Clamp on the cable suspension Strand of both lashed and ring supported cable and also methods of running Drop Wire from the span clamp to the pole.

**1.02** This section is reissued to delete reference to reuse of old span clamp on suspension strand of ring supported cable and reuse of B Span Clamp on suspension strand of lashed cable.

**1.03** Span clamps should be used only when it is impractical to string the subscriber's drop directly from a pole. Some of the conditions which will necessitate the use of span clamps are:

- (a) Right of way difficulty in crossing private property.
- (b) Avoidance of trees in placing subscriber drops.
- (c) Where Guard Arms would otherwise be necessary to provide pole climbing space.
- (d) Where a number of attachments to masonry building can be avoided.
- (e) To avoid interference from clothes lines and other obstructions.

**2. PLACING C SPAN CLAMP ON SUSPENSION STRAND OF LASHED AND RING SUPPORTED CABLE**

**2.01** Loosen the nut of the clamp until the jaws open sufficiently to admit the suspension strand. Place the clamp on the strand in a verti-

cal position with the hook facing the subscriber's building to be served. Take up on the nut with a Lineman's Wrench or P side Cutting Pliers until the clamp is firmly bolted on the strand. On lashed cables, position the C Span Clamp between adjacent crossings of the Lashing Wire over the top of the strand.

**2.02** Where C Span Clamps are placed on 2200 pound strand supporting lashed or ring-supported block cable, it will be necessary to place a serving of 45 Mil C Steel Lashing Wire on the strand before installing the clamp. The wraps should be spaced about 1/4 inch apart and cover about a 3-inch length of strand. After the clamp is bolted on the wire wrapped strand, break off the excess length of wire serving falling outside the ends of the clamp. On lashed block cable, protect the cable sheath under the clamp with 3 wrappings of Lashed Cable Support as shown in Para. 3.03 in connection with the use of C Span Clamps.

**3. RUNNING DROP WIRE FROM C SPAN CLAMP TO POLE**

**3.01** Place not more than two (2) drop wires between the C Span Clamp and the pole or guard arm attachment.

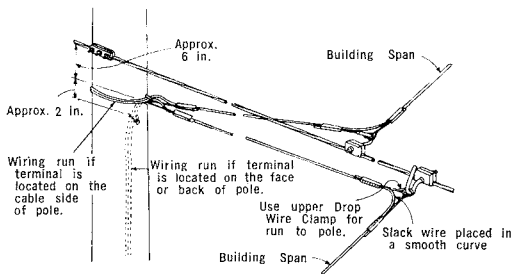


**SECTION 462-300-205CA**

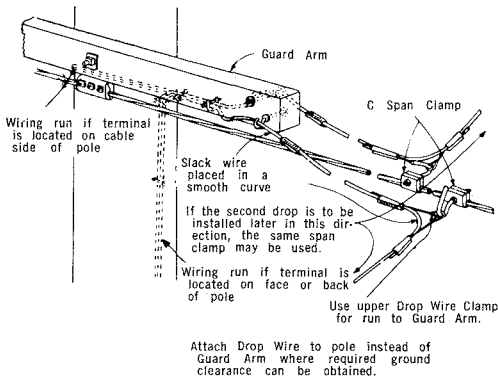
**3.02** Where the distance between C Span Clamp and Cable Suspension Bolt is over three (3) feet, support the drop wire run as indicated below. Use the uppermost Drop Wire Clamp on the hook of the C Span Clamp to support the drop wire span to the pole in order to obtain maximum separation between drop wire and cable.

**(a) On Spans to Drive Hooks on Pole**

**Spans To Drive Hooks  
(Cable omitted for clarity)**



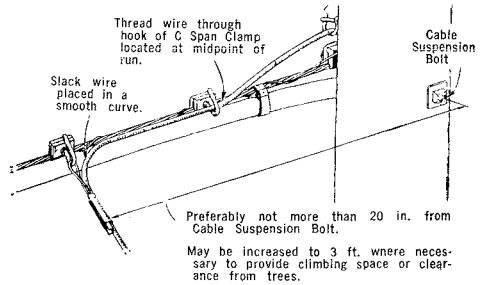
**(b) On Spans to Guard Arm on Pole  
Spans To Guard Arm  
(Cable omitted for Clarity)**



**3.03** Where the distance between C Span Clamp and cable suspension bolt is three (3) feet or less, support the drop wire span as indicated below.

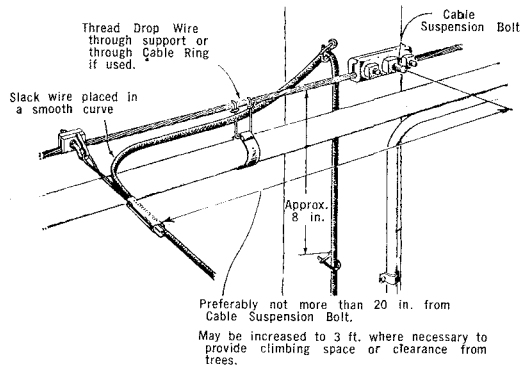
**(a) With Lashed Cable**

**C Span Clamp Within Three Feet of  
Cable Suspension Bolt  
(Lashed Cable)**



**(b) With Ring Supported Cable**

**C Span Clamp Within Three Feet of  
Cable Suspension Bolt  
(Ring Supported Cable)**



## DROP AND BLOCK WIRING

### FASTENING AND EQUIPPING FIRST ATTACHMENTS OF DROP WIRE RUNS TO BUILDING

#### 1. GENERAL

1.01 This section specifies:

- The rules to be followed in planning drop wire runs to buildings
- The methods of fastening and equipping first attachments
- The fastener to be used on various type surfaces.

1.02 Clearances over public and private swimming pools are not covered by Safety Codes or other practices. However, for reasons of safety, sanitation, and appearance, aerial drop wire crossing over swimming pools should be avoided.

1.03 The attachments to be used in any installation depend on a number of factors, such as:

- Number of drops to be placed
- Angle at which drop approaches building
- Insulated or noninsulated attachments.

1.04 Drop wire attachments for use on all types of walls are listed in the Section entitled Attaching Devices for Walls.

1.05 The use of insulated or noninsulated attachments is covered in the section entitled Station Protection Required for Various Conditions of Plant and Exposure.

1.06 In order to obtain secure attachments and to avoid damage to building surfaces it is essential that the specific instructions covered in the section entitled Attachments and Fasteners,

Description of Surfaces Encountered, be followed. Of particular importance are the clearance and lead holes for fasteners.

1.07 When attaching galvanized attachments on buildings with aluminum siding in highly corrosive areas (industrial and marine) observe the following:

- Apply a coating of antirust and antiseize compound to the siding at the point of contact to prevent corrosive action.



*It is possible for foreign voltage to be present on buildings covered with metal siding. Test siding with Z Voltage Tester before starting any work.*

1.08 After making a lead hole on buildings with metallic or vinyl siding, apply a sufficient amount of rubber silicone base sealant or strip seal compound over the hole to provide a moisture proof sealant around the shank of the angle screw or drive ring when installed.

#### 2. RULES

2.01 In planning drop wire runs to buildings observe the following instructions:

- (a) Locate the first building attachment so that the drop span will have the required clearance from light or power wires, trolley wires, other foreign wires, and metallic objects.
- (b) Locate the first building attachment so as to avoid tree interference, keeping in mind the future growth of existing trees. It is preferable to make a longer wire run on the building if by so doing the trees can be cleared.
- (c) Locate the first building attachment so that the drop span can be placed with adequate sag.
- (d) *Where practical*, locate the first building attachment, when two or more drop wires to a building are involved, preferably at the same

point, bearing in mind that the locations of the initial and subsequent attachments should be such as to provide satisfactory wire runs in the span and on the building.

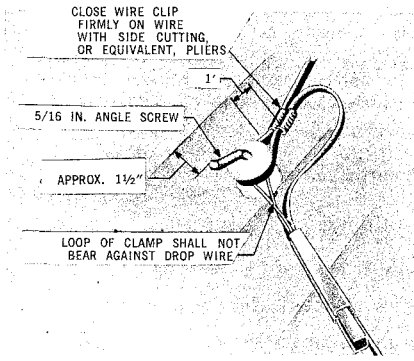
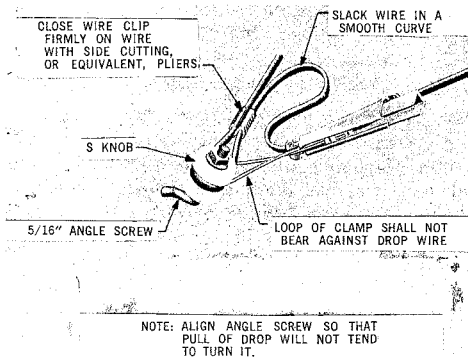
- (e) *Where practical*, locate the first building attachment so the drop wire will make a direct vertical run to the last attachment, provided that the drop wire in the span would have adequate clearance from trees, would not be objectionable if it crosses adjacent property, or would not cross portions of vacant lots on which buildings are likely to be erected.
- (f) *Where practical*, locate the first building attachment so that ice and snow falling from the roof will not strike the drop wire. If the drop wire in the span must pass under the sloping part of a roof, make the first attachment as near the eaves as possible.

- (g) Locate the first attachment so that anchors will not be placed less than 10 inches to a corner or top of a wall, except in turning corners.
- (h) Do not make any holes in metallic siding for attachments, without the approval of the supervisor and customer.
- (i) Locate attachments in metallic and vinyl siding within 1 inch below the lip of the upper clapboard.

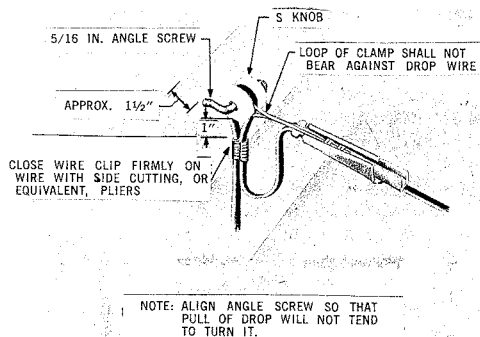
**3. TYPICAL FIRST ATTACHMENTS TO BUILDINGS AND STEEL STRUCTURES (Fig. 1 through 9)**

**3.01** Tables A, B, C, and D list anchoring devices of first attachments used on various surfaces.

**3.02** Table E lists equipping information for first attachments.



**Fig. 1 — First Attachment, Angle Screw (Drop Wire Run in Horizontal Direction on Building)**



**Fig. 2 — First Attachment, Angle Screw (Drop Wire Run in Vertical Direction on Building)**

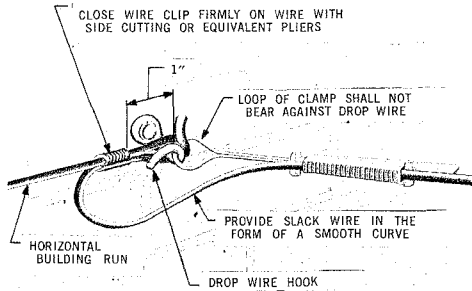


Fig. 3 — First Attachment, Drop Wire Hook

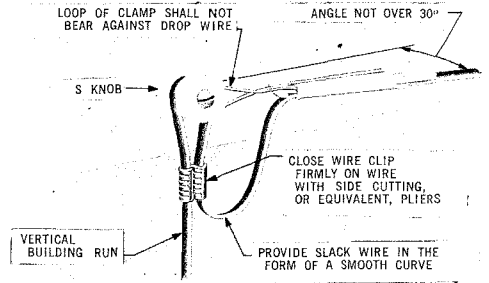


Fig. 4 — First Attachment, S Knob

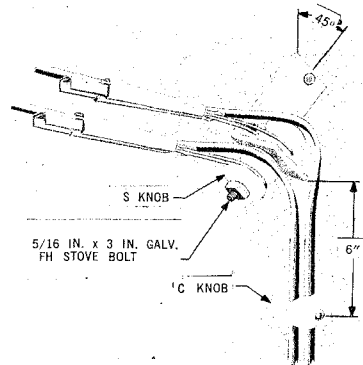
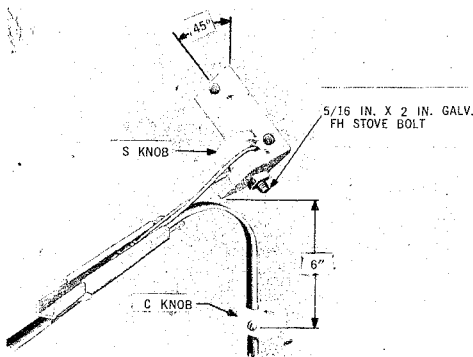
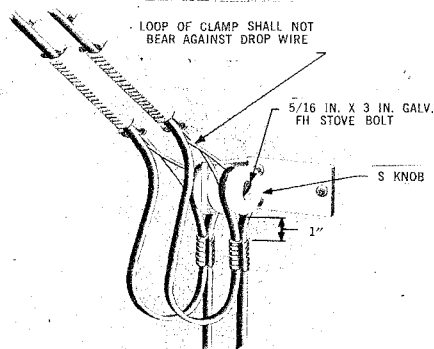


Fig. 5 — First Attachment, House Bracket (Drop Wire Run in Vertical Direction on Building)

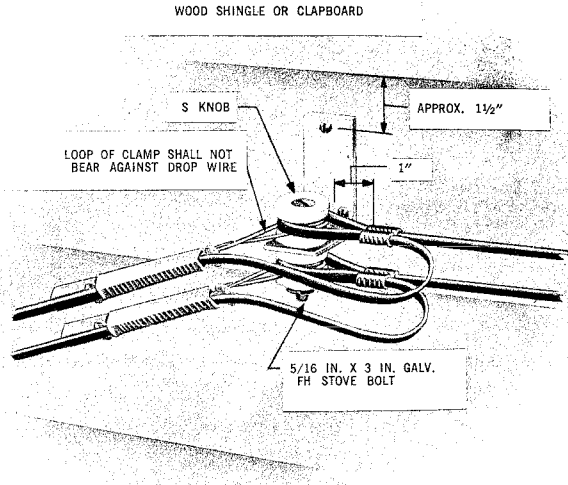


Fig. 6—First Attachment, House Bracket (Drop Wire Run in Horizontal Direction on Building)

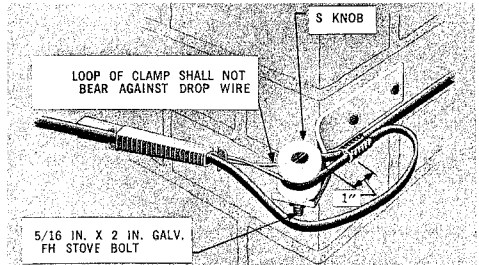
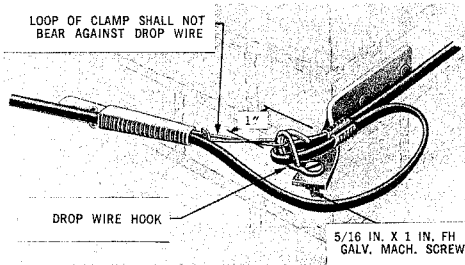


Fig. 7—First Attachment, Corner Bracket

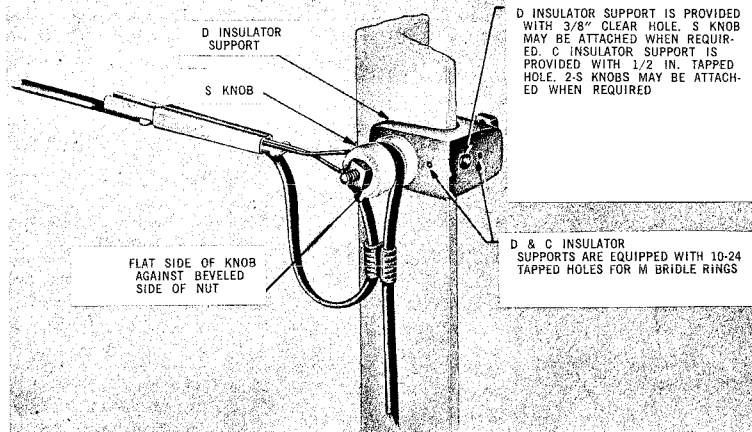


Fig. 8 – First Attachment D or C Insulator Support

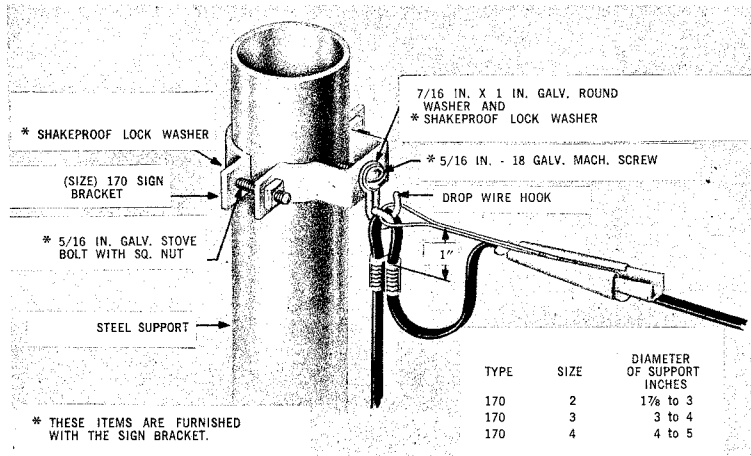


Fig. 9 – First Attachment, Sign Bracket, 170 Type

**TABLE A**  
**FASTENERS FOR DROP WIRE HOOK**

Wall Type	Fasteners		Remarks
	Quantity	Type	
Wood Siding, Shingle, Metallic Siding, Vinyl Siding	1	2-in. No. 18 RH galvanized wood screw	Drill clearance hole to avoid splitting the siding. Place $\frac{1}{2} \times \frac{1}{4}$ in. washer between wall and drop wire hook. Place screw in studding.
Stucco on Wood	1	2-in. No. 18 RH galvanized wood screw	Place screw in studding.
Rigid Composition Shingles	1	2-in. No. 18 RH galvanized wood screw	Drill clearance hole to avoid splitting shingle.
Masonry or Substantial Brick Veneer*	1	5/16-in. by 1-3/4-in. hammer drive anchor	Locate anchor in center of brick. Second drop wire hook should be located in separate brick.
Thin Wall Brick Veneer (Less Than 3-3/4 Inch Thickness)	1	6-in. No. 18 RH galvanized wood screw	Pass screw through the seam between bricks. Penetrate wood backing approximately 1 inch.
Hollow Tile	1	5/16-in. by 5-in. RH galvanized toggle bolt	Place 7/16 in. by 2-in. galvanized square washer between wall and drop wire hook.

\* Do not use corner or top row of bricks.

**TABLE B**  
**FASTENERS FOR S KNOBS**

Wall Type	Attachment Knob	Fasteners		Remarks
		Quantity	Type	
Wood Siding, Shingle, Metallic Siding, Vinyl Siding	S	1	2-1/2 in. No. 18 FH galvanized wood screw	Drill clearance hole to avoid splitting the siding. Place screw in studding.
Stucco on Wood	S	1	3-in No. 18 FH galvanized wood screw	Use 3-1/2 in. If necessary to penetrate studding.
Rigid Composition Shingles	S	1	3-1/2 in. No. 18 FH galvanized wood screw	Drill clearance hole to avoid splitting shingle.
Thin Wall Brick Veneer (Less Than 3-3/4 Inch Thickness)	S	1	7-in. or 4-1/2 in. No. 18 FH galvanized wood screw	Pass screw through the seam between bricks. Penetrate wood backing approximately 1 inch.
Hollow Wall	S	1	5/16 in. by 5 in. RH galvanized toggle bolt	Place flat side of S knob against bolt head.

**TABLE C**  
**FASTENERS FOR HOUSE BRACKETS**

Wall Type	Fasteners		Remarks
	Quantity	Type	
Wood Siding, Shingle Metallic Siding, Vinyl Siding	3	2-in. No. 14 RH galvanized wood screws	Drill clearance hole to avoid splitting the siding. Place screw in studding.
Stucco on Wood	3	2-1/2 in. No. 14 RH galvanized wood screws	Place screw in studding.
Rigid Composition Shingles	3	3-in. No. 14 RH galvanized wood screws	Drill clearance hole to avoid splitting shingle.
Masonry or Substantial Brick Veneer	2	1/4 in. by 1-1/4 in. hammer drive anchor	
Thin Wall Brick Veneer (Less Than 3-3/4 Inch Thickness)	2	6-in. No. 14 RH galvanized wood screws	Pass screw through the seam between bricks. Penetrate wood backing approximately 1 inch.
Hollow Wall	2	1/4 in. by 3 in. or 4 in. RH galvanized toggle bolt	

**TABLE D**  
**FASTENERS FOR CORNER BRACKETS**

Wall Type	Fasteners		Remarks
	Quantity	Type	
Wood Siding, Shingle Metallic Siding, Vinyl Siding	2	2-in. No. 14 RH galvanized wood screws	Drill clearance hole to avoid splitting the siding. Place screw in studding.
Stucco on Wood	2	2-1/2 in. No. 14 RH galvanized wood screws	Place screw in studding.
Rigid Composition Shingles	2	3-in. No. 14 RH galvanized wood screws	Drill clearance hole to avoid splitting shingle.
Masonry or Substantial Brick Veneer	2	1/4 in. by 1-1/4 in. hammer drive anchor	
Thin Wall Brick Veneer (Less Than 3-3/4 Inch Thickness)	2	6-in. No. 14 RH galvanized wood screws	Pass screw through the seam between bricks. Penetrate wood backing approximately 1 inch.
Hollow Wall	2	1/4 in. by 3 in. or 4 in. RH galvanized toggle bolt	



**TABLE E**  
**EQUIPPING DROP WIRE ATTACHMENTS WITH S KNOB, OR DROP WIRE HOOK**

Attachments		Equipped with		Hardware	Remarks
		S Knob	Drop Wire Hook		
Angle Screw	5/16 in.	1		Nut furnished	Place flat side of knob against bevelled side of nut.
	3/8 in.				
House Bracket		1		5/16 in. by 2 in. FH galvanized stove bolt	Place flat side of first knob against house bracket.
		2*		5/16 in. by 3 in. FH galvanized stove bolt	Place flat side of knob against bevelled side of nut.
			1	5/16 in. by 1 in. FH galvanized machine screw	Obtained locally.
Corner Bracket		1		5/16 in. by 2 in. FH galvanized stove bolt	Place flat side of knob against corner bracket.
		2*		5/16 in. by 3 in. FH galvanized stove bolt	Place flat side of top knob against bolt head and place nut against flat side of lower knob.
			1	5/16 in. by 1 in. FH galvanized machine screw	Obtained locally.
Insulator Supports	D	1		5/16 in. by 2 in. FH galvanized stove bolt	Place flat side of second knob against bevelled side of nut.
	C	2		3/8 in. by 3 in. galvanized machine bolt	
	D		1	5/16 in. by 1 in. FH galvanized machine screw	Obtained locally.
	C				
Sign Bracket, 170 Type			1	5/16 in. by 3/4 in. RH galvanized machine screw	Machine screw and lock washers furnished. Obtain 7/16 in. by 1 in. galvanized round washer locally.

\* Locate one knob above and one knob below bracket.

#### 4. FIRST ATTACHMENTS ON LOW BUILDINGS

4.01 Parts 4, 5, and 6 provide information on typical first attachments on low buildings using house fixtures provided by customers to obtain necessary ground clearance for drop wire.

4.02 Where house clearance fixtures are required but have not been provided or where joint use of a fixture is impracticable, refer the matter to your supervisor.

4.03 Where clearance fixtures are provided but the required minimum ground clearance for drops cannot be obtained, refer the matter to your supervisor.

#### 5. PRECAUTIONS

5.01 Observe the following precautions when planning attachment to a subscriber-owned clearance fixture.

(a) Avoid climbing on roofs of subscriber premises.

(b) Before making attachment, inspect fixtures, but do not make an attachment if there is any doubt as to the strength or firmness of the fixture.

(c) On joint-use fixtures observe location of the power service drops in order to avoid body contact. Wear insulating gloves and Z Protective Cap when making attachment to the fixture. Obtain a separation of at least 1 foot between telephone and power wires.

(d) When handling asphalt shingles, care should be taken as they become brittle in cold weather.

#### 6. CLEARANCE FIXTURES AND METHODS OF ATTACHMENT

6.01 Figs. 10 through 14 show types of clearance fixtures commonly provided by subscribers and the recommended methods of making drop wire attachment. Where other types of fixtures are provided and different methods of making drop wire attachments are required, local instructions should be issued.

#### 7. 123A1 PROTECTOR MOUNTED ON POWER STACK

7.01 The 123A1 Protector can be attached to the power stack *only* in areas with a multi-grounded electrical system.

7.02 The power stack must be tested with the Z Voltage Tester before proceeding with work operations.

7.03 Observe location of the power service drops in order to avoid body contact. Wear insulating gloves and Z Protective Cap when making attachment to the fixture. Obtain a separation of at least 1 foot between telephone and power wires.



*The 123A1 Protector should be mounted on the power stack only on buildings in areas where a water pipe is not available as a first choice ground.*

SECTION 462-350-213CA

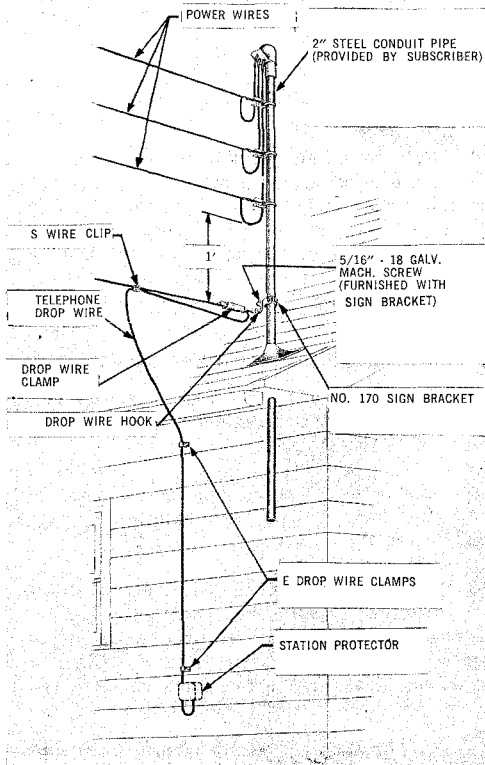


Fig. 10—Drop Wire Attached to Power Fixture

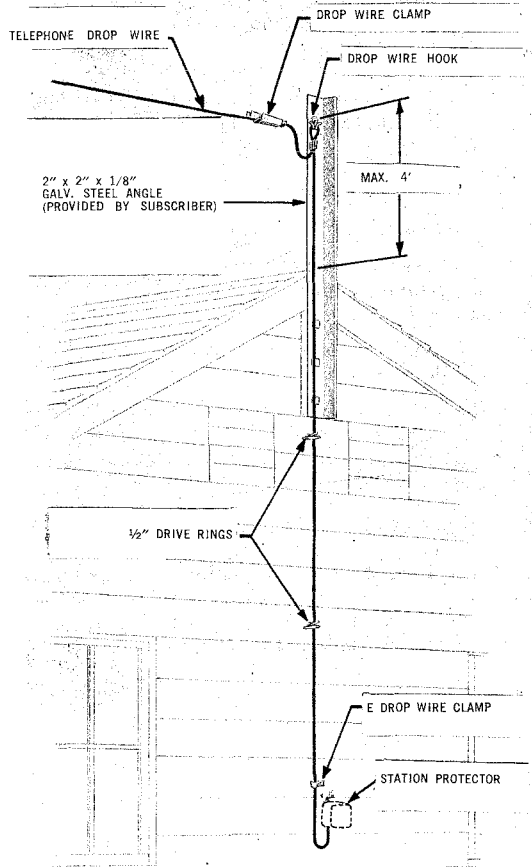


Fig. 11—Drop Wire Attached to 2-Inch Angle Iron

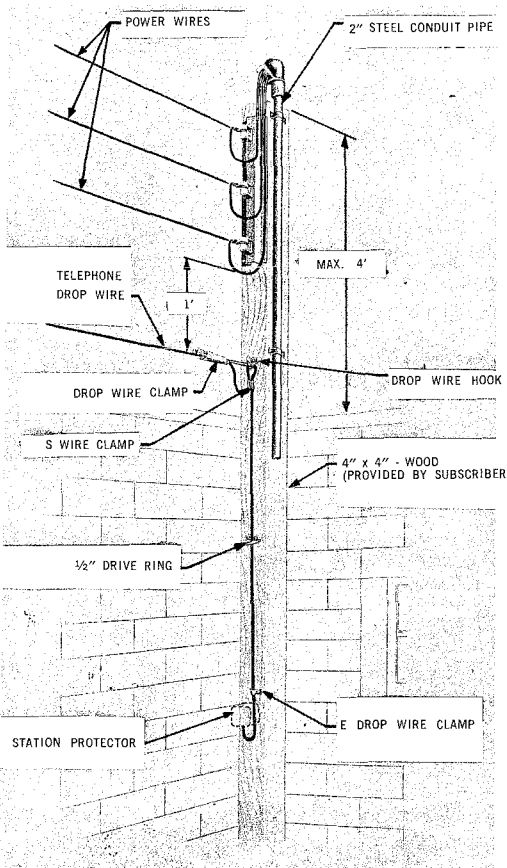


Fig. 12 — Drop Wire Attached to Subscriber Pole

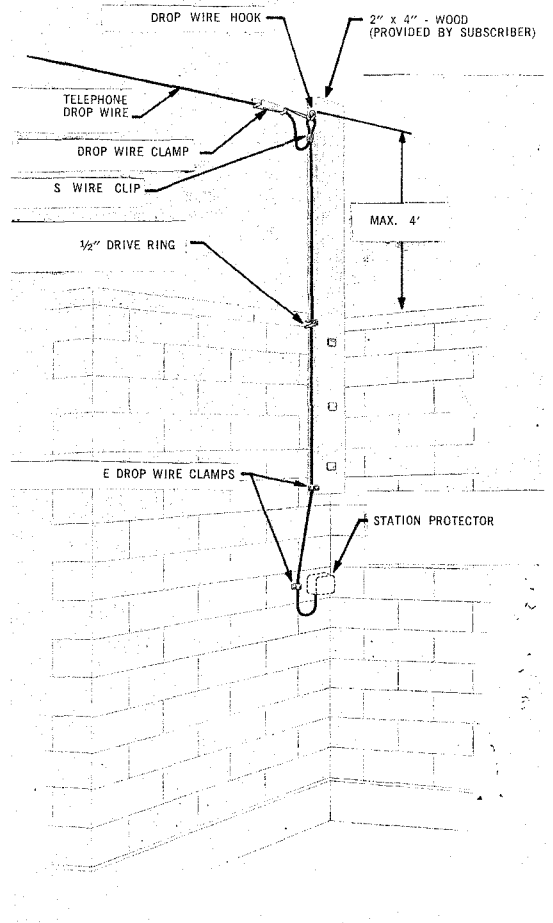


Fig. 13 — Drop Wire Attached to 2-Inch by 4-Inch Wood Beam

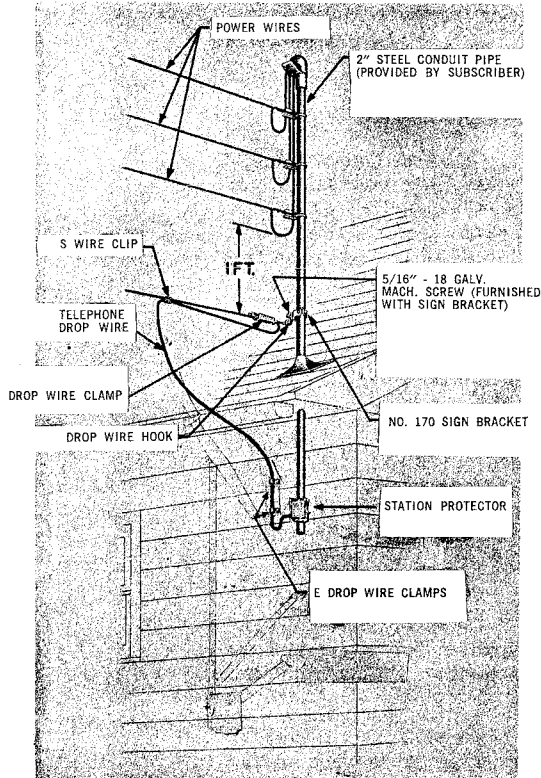


Fig. 14 – Drop Wire 123A1 Protector Attached to Power Fixture

## DROP AND BLOCK WIRING

### FASTENING AND EQUIPPING INTERMEDIATE AND LAST ATTACHMENTS FOR DROP AND BLOCK WIRE RUNS ON BUILDINGS

#### 1. INTRODUCTION

1.01 This section specifies:

- The methods of fastening and equipping intermediate and last attachments.
- The fastener to be used on various types of walls.
- The methods of running drop and block wire on building walls and structures.
- The methods of running drop and block wire inside of buildings.
- The rules to be followed in planning drop and block wire runs on buildings.

1.02 The attachments to be used in any installation depend on a number of factors, such as:

- Number of drops to be used.
- Type of surface to be attached to.
- Insulated or non-insulated attachments.

#### 2. GENERAL

2.01 The M bridle ring is a closed type ring.

A machine screw 10-24 thread is provided at one end for use with insulator supports or B beam clips.

2.02 The B beam clip can be used with drive rings or machine threaded bridle rings to support drop wires on structural framework for intermediate attachments.

2.03 The 1/2-inch L drive rings are equipped with nails 1/2 inch longer than those used in regular similar sizes. They are intended for use on building walls covered with thick siding mat-

erials through which adequate penetration cannot be obtained with regular rings.

2.04 When using ladders to install attachments, observe precautions covered in Division 081.

#### 3. RULES

3.01 In planning drop and block wire runs on buildings, observe the following rules:

**Caution: Do not use block wire as any part of the connection between exposed plant and the protectors, except when used as the bridle fuse wire on stations served from open wire, C rural, or 19-gauge multiple line wire with a 123A1A protector. Block wire may be used on the station side of protector.**

(a) Rules applying to both drop and block wire runs.

(1) Plan the wire run so that the locations of the points of entrance and of the station protectors, where the latter are required, will conform to the rules covered in the Section entitled Station Protection, Installation.

(2) NC, and NE drop wires and Z and X multiple drop wires working out of metal sheath cable shall be supported on un-insulated building attachments on all types of building walls. (Where station protection is required, the Z and X multiple drop wire shall be fully protected with fuseless protectors.)

(3) Drop wires connecting to open wire circuits, however, shall be separated from flammable building walls such as wood, stucco on wood, or metallic siding on wood and supported on insulated building attachments.

## SECTION 462-350-214CA

(4) Locate the first building attachment for drop wire and the attachments for block wires so that the wires will have the required clearance above highways, driveways, walks, private property, roofs, etc.

(5) If it is necessary to cross or parallel electric conduits, radio wiring, rain spouts, or other obstructions on buildings, obtain the required separations as outlined in Section 620-220-011.

(6) Do not run wires in front of signs or so as to interfere with fire escapes, clothes lines, awnings, shutters, hoists, doors, etc. Make adequate allowance for the normal movement of such devices.

(7) Do not place wire runs on walls which are likely to be built against in the near future.

(8) Do not run wires diagonally on a building, except in the short lengths required to change the direction of the run from horizontal to vertical, etc.

*Caution: It is possible for foreign voltage to be present on buildings covered with metal siding. Test siding with Z voltage tester before starting any work.*

**3.02** The following rules shall be observed only in so far as practicable, since it may be impracticable in some installations to follow all of these instructions as well as those given in 3.01.

(a) Rules applying to both drop and block wire runs.

(1) Locate the wire run with a view to permanency and accessibility. Avoid locating the run at an excessive height. Where it is impracticable to use a ladder or one is not available, attachments may be placed from windows. Install such attachments as near the preferred locations as safety permits.

(2) Do not make attachments to chimneys as the fastenings may be insecure or may result in property damage.

(3) On building walls finished with stucco, rigid composition shingles, thin-wall brick veneer, and similar materials, locate attachments on wood trim if practicable and if the trim is sufficiently substantial to provide adequate support for the drop wire.

(4) Locate the wire run preferably on the rear and side walls of a building.

(5) Locate horizontal runs above the reach of the public, particularly children.

(6) On a brick building with a stone foundation, establish the run on the brick wall rather than on the rough stone of the foundation.

(7) Avoid attaching to tin, sheet metal, and materials requiring frequent repairs or renewals.

(8) Avoid locating wire run on intermediate buildings that are in a deteriorated condition or are of a temporary nature. In such cases, it is preferable to install aerial spans between well-built permanent buildings.

(9) Select a run where the wires will be as free as practicable from mechanical injury.

(10) Locate the run so as to require the minimum length of wire and as few turns as practicable.

(11) Locate the wire run so as to avoid light and power wires and so that it will encounter a minimum number of other obstructions.

(12) Locate attachments so that anchors will not be placed closer than 10 inches to the corner or the top of a wall, except in turning corners.

(13) Establish a vertical run preferably in the angle formed by intersecting walls if this would not increase the length of the run appreciably.

(14) Where ice conditions are severe, avoid locating vertical wire run within 2 feet of a leader (down spout).

**3.03** When establishing a wire run on a building wall where cable has been placed, the wire run should, in general, parallel the cable run. If practicable, rings installed in conjunction with the cable clamps should be utilized for such runs.

**3.04** Reuse an existing block wire at a reinstallation wherever practicable. Inspect the wire carefully and if necessary:

- (1) Tighten all loose rings and replace missing rings.
- (2) Remove excess slack in run.
- (3) Place protection where necessary around leaders, electrical conduits, and other obstructions.
- (4) If the insulation is weatherworn to such an extent as to indicate that the service is likely to be impaired in the near future because of low insulation, replace the portion which would be likely to introduce trouble.
- (5) Remove strings or other foreign matter which may detract from wire run appearance.

**3.05** A large number of bridle wires in a ring run is uneconomical; where the number exceeds six, call the attention of your supervisor to the condition in order that the question of placing block cable may be considered.

#### **4. SPACING OF ATTACHMENTS**

**4.01** Space drop wire attachments 9 feet or less

apart on horizontal runs and 12 feet or less apart on vertical runs.

**4.02** Space block wire attachments 4 feet or less apart on horizontal runs and 8 feet or less apart on vertical runs.

**4.03** Place additional attachments as required to keep exposed wires terminated at fused-type protectors from touching flammable surfaces.

**4.04** Where windows are available for making attachments on vertical runs, place an attachment at each floor.

**4.05** When paralleling cable is attached to building wall by cable clamps, place rings in every third cable clamp where clamps are 17 inches apart and in every other cable clamp where clamps are 26 inches apart.

**4.06** When paralleling cable is placed on a strand, use cable rings for block wires.

#### **5. WIRE CARRYING CAPACITIES OF DRIVE RINGS, BRIDLE RINGS, AND INSULATED SCREW EYES**

**5.01** Table A indicates the type and size of bridle rings, drive rings, and insulated screw eyes to be used under various conditions.

**5.02** Table B indicates the drop, block, and multiple drop wire capacity for drive rings, bridle rings, and insulated screw eyes.

**5.03** Table C indicates the fastener to be used on drop and block wire attachments on various types of walls.



TABLE A

TYPE AND ULTIMATE SIZE OF WIRE RUN	TYPE		
	Z BRIDLE RING	DRIVE RING	INSULATED SCREW EYE
In runs where not more than six bridle wires will be required	1-1/4 in.	5/8 in.	5/8 in.
In runs where more than six bridle wires will be required	1-1/4 in.	7/8 in.	1 in.
At distributing terminals 16 pairs or less	1-1/4 in.	7/8 in.	
In runs where bridle rings with machine screw shanks are required	M bridle ring		

TABLE B

TYPE OF RING OR INSULATED SCREW EYE	SIZE	MAXIMUM NUMBER OF WIRES		
		NC OR NE DROP WIRE	BLOCK WIRE	MULTIPLE DROP WIRE
Drive Rings	1/2 and 1/2 L*	2	8	0
	5/8	6	9	1
	7/8	16	22	2
Z Bridle Rings	1-1/4	16	22	2
M Bridle Ring	1-1/4	16	22	2
Insulated Screw Eyes	5/8 S and L*	4		0
	1 S and L*	10		1

\* L represents longer shank.

**TABLE C**  
**FASTENERS FOR DROP AND BLOCK WIRE ATTACHMENTS**

ATTACHMENT		FASTENER		TYPE OF CONSTRUCTION	REMARKS
		QUANTITY	TYPE		
Drive Rings	1/2 in.	1	3/16 in. x 7/8 in. hammer drive anchor	Masonry or Substantial brick veneer	
	5/8 in. and 7/8 in.	1	1/4 in. x 1 in. hammer drive anchor		
	1/2 in. L	1	1/4 in. x 1-1/2 in. hammer drive anchor		
Z Bridle Rings	5/8 in.	1	5/8 in. x 6-3/4 in.	Brick Veneer	
M Bridle Rings		1	B beam clip insulator support	Angle irons, I beams, etc.	
C Knob (used only where fused protectors are required)		1	2-1/2 in. No. 10 RH galvanized wood screw	Exposed wood-work (outdoors)	Locate screw approximately 1 in. above bottom shingle or clapboard.
		1	2 in. No. 8 RH wood screw	Exposed wood-work (indoors)	
		1	3 in. No. 10 RH galvanized wood screw	Stucco on wood	
E Drop Wire Clamp		1	1 in. No. 8 RH galvanized wood screw in a No. 10 plastic anchor	Brick	Locate screw approximately 1 in. above bottom shingle or clapboard.
		1	1 in. No. 8 RH galvanized wood screw	Wood siding or shingle and Metallic siding on wood	
		1	3/16-in. x 3-in. toggle bolt	Hollow tile	

**Note:** The L type is equipped with longer shank.

**6. INSTALLING DRIVE RINGS, AND Z BRIDLE RINGS**

**6.01** Drive rings (with suitable masonry fasteners) should be used wherever metal rings are permitted by the Practices. Z Bridle rings may, however, be substituted for drive rings on brick veneer under the following conditions:

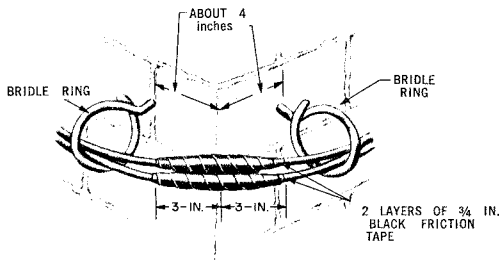
- (a) Where point of drive-ring nail would extend beyond the wood frame of a building, contractor's shanty, etc.
- (b) Where it is likely that clothing would catch on drive rings installed in narrow passageways, alleys, etc.
- (c) Where property owner objects to drive rings.
- (d) Where drive rings are likely to split wood-work.
- (e) In situations where Z bridle rings can be used to better advantage than drive rings.

*Wear eye protection when drilling holes or driving masonry fasteners into masonry or brick walls.*

**7. PLACING Z BRIDLE RINGS AND INSULATED SCREW EYES**

**7.01** Place Z bridle rings and insulated screw eyes where run is horizontal, so that the opening is at the top. On bends, the opening shall be at the outer side of the bend.

**7.02** Where a wire run turns an outside corner of the supporting structure, place bridle rings or insulated screw eyes as shown in Fig. 1.



**Fig. 1 — Z Bridle Rings**

**8. INSTALLING INSULATED SCREW EYES AND C KNOBS**

**8.01** Insulated screw eyes should be used in place of drive rings or Z bridle rings on drops where fused station protection is required and where the building walls are flammable material such as wood, stucco on wood, and metal siding on wood.

**8.02** The C knob may be used as an intermediate attachment where not more than two wires are to be placed.

**9. EQUIPPING AND INSTALLING W LEADER BRACKET**

**9.01** The W leader bracket is a metal strap designed to be installed over small obstructions such as pipes, rain spouts, etc, on walls. The bracket will clear obstructions extending five inches from wall surfaces. The W leader bracket has a single-tapped hole in the center for equipping it with an M bridle ring.

**10. EQUIPPING AND INSTALLING INSULATOR SUPPORTS AND B BEAM CLIPS ON STEEL STRUCTURES**

**10.01** The B, C and D insulators support and the B beam clip are used to secure intermediate attachments to I beams, angle irons, etc.

**10.02** The B, C or D insulators support may be equipped with an M bridle ring.

**10.03** The B beam clip may be equipped with an M bridle ring or a 5/8 or 7/8 inch drive ring.

**10.04** B, C or D insulator supports are secured to steel structures by tightening set screws. They may be used on flanges up to 1 inch thick.

**10.05** B beam clips are held secured by spring tension of the clip. They can be used on flanges ranging from 1/8 inch to 1/2 inch thick. On thick flanges, the B beam clip may require driving into place with a hammer.

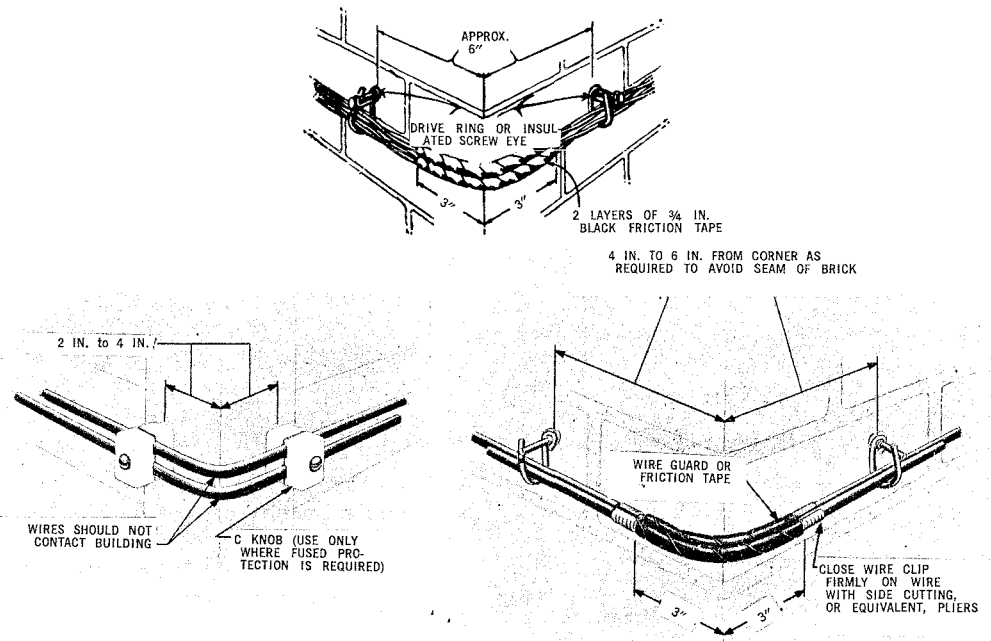
*Avoid personal injury by protecting eyes and hands when installing clip.*

**11. INTERMEDIATE ATTACHMENTS ON BUILDINGS**

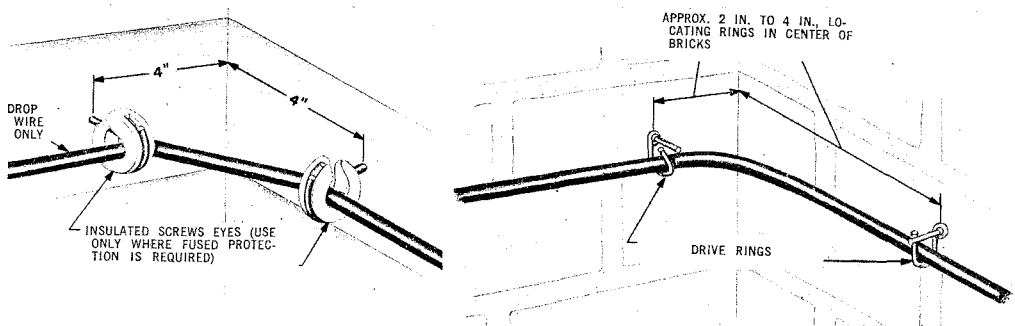
**11.01** In order to locate a line for the straight run, either horizontal or vertical, a chalk line may be stretched between two points of the run and line snapped against the wall. When locating ring run in this manner, insure that the chalk line is tight enough and that points selected

are close enough together so that there is no appreciable sag in the line. Snap the chalk line squarely against the wall.

**11.02** Typical drop and block wire runs using a variety of attachments are shown in Fig. 2 through 5.



**Fig. 2 - Intermediate Building Attachments at Outside Corners**



**Fig. 3 - Intermediate Building Attachments at Inside Corners**

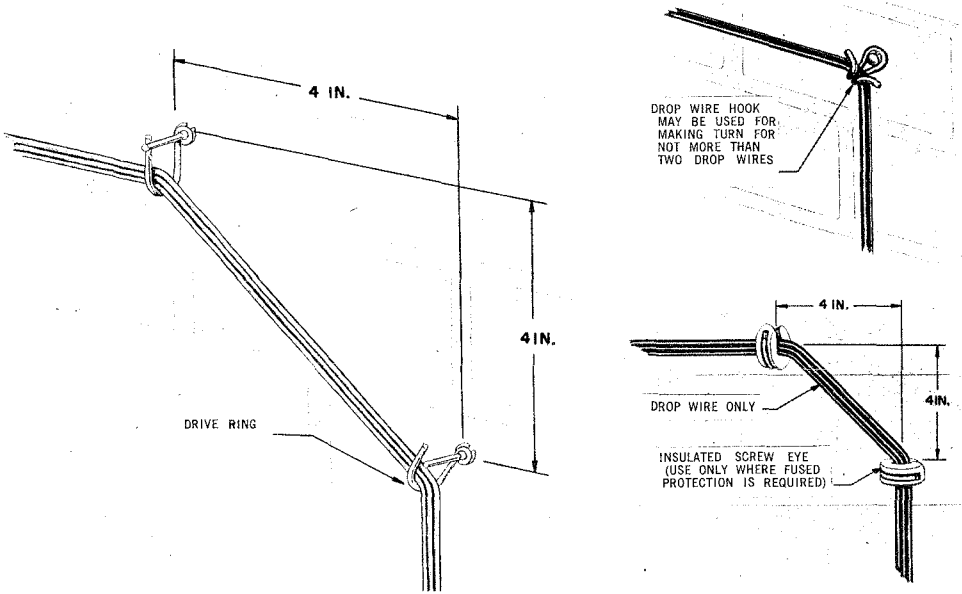


Fig. 4 - Intermediate Building Attachments to Change Direction of Wire Run

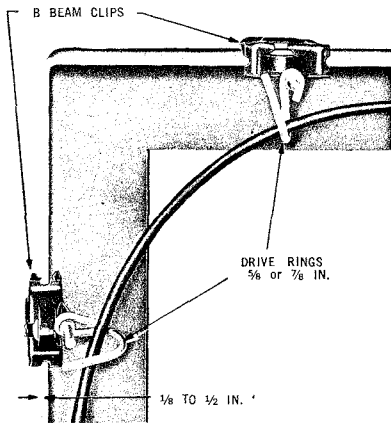


Fig. 5 - Intermediate Attachment - B Beam Clips for Use on Metal Structures

12. PARALLELING CABLE RUN

12.01 When establishing a wire run on a building wall where cable has been placed, the wire run should be attached as described below: Cable run attached with clamps (Fig. 6)

- Place a drive ring in every third cable where clamps are 17 inches apart and in every other clamp when they are 26 inches apart.

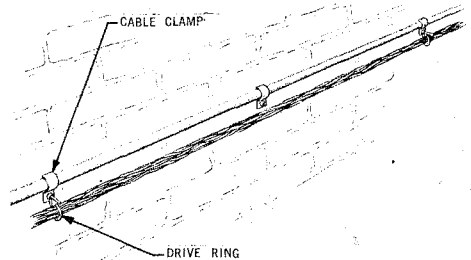
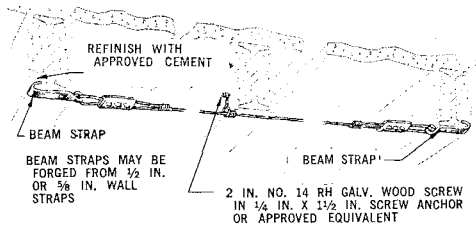


Fig. 6 - Drive Ring Run Paralleling Cable Attached with Cable Clamps

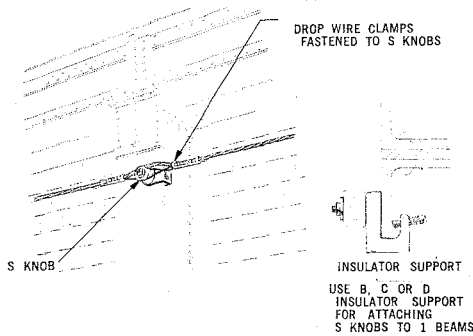
**13. ATTACHMENTS TO INDUSTRIAL STRUCTURES**

**13.01** Manufacturing buildings, warehouses, piers, etc, may require special means of attachment. Methods of attachment which have proven practicable in such cases are shown in Fig. 7, 8 and 9.

**13.02** The exact method of attachment used in this class of building will depend upon the particular type of building encountered.



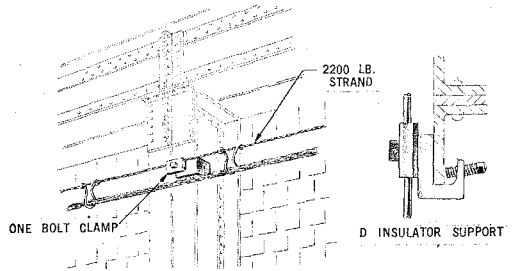
**Fig. 7 — Strand on Beam Straps**



**Fig. 8 — Strand on S Knob and One-Bolt Clamp**

**14. AERIAL BLOCK WIRE SPANS**

**14.01** Block wire must not be used in aerial spans that will introduce an exposure.

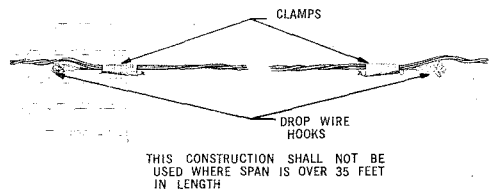


**Fig. 9 — Strand on One-Bolt Clamp**

**14.02** Where aerial span crosses driveway or private property, provide proper clearances.

**14.03** Where span is 5 feet or less, bridle wire may be run without special supports, that is, without being attached to knobs or drop wire hooks at the ends of the span. Where a good appearance is not essential and the run is out of the reach of children, this distance of unsupported bridle wire may be increased to 12 feet. Where span is longer than this distance, use construction specified in 14.04 to 14.05.

**14.04** Where only a few bridle wires will be run and the span is 35 feet or less in length, the construction shown in Fig. 10 may be employed.



**Fig. 10 — Span Less Than 35 Feet in Length**

**14.05** Where span is more than 35 feet in length, use drop wire attached at each end on drop wire hooks.

**SECTION 462-350-214CA**

**14.06** In blocks where the growth will be slow, the wires may be run along the backs of buildings attached to drop wire hooks S knobs, provided span length will not exceed 35 feet.

**14.07** Use a S knob for each drop wire.

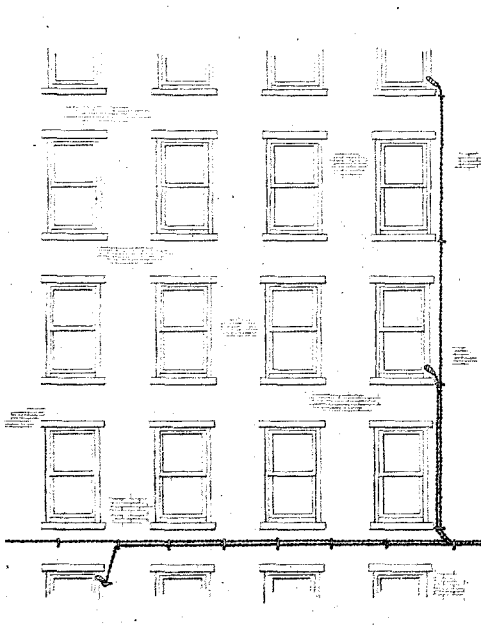
**15. PARTY LINE TAPS**

**15.01** In making a party line connection, a bridge may be made at the most accessible point in an existing wire run, provided that this point is

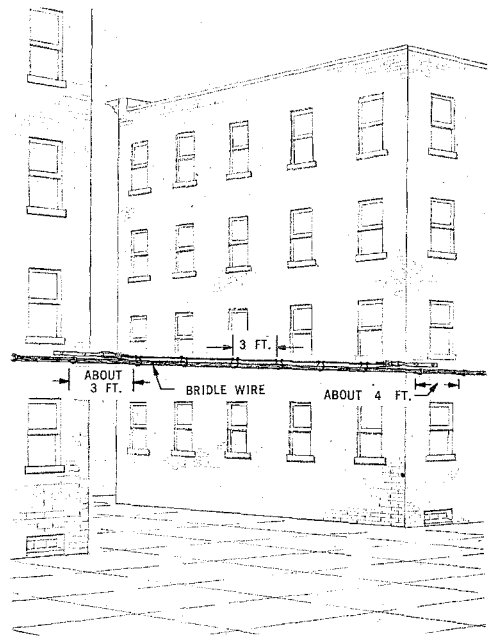
50 feet or more away from the terminal or if there is no space available on the binding posts for terminating the new party. If the most convenient point for bridging in the run is within 50 feet of the terminal, run the wire to the terminal provided that there is space available on the binding posts.

**16. TYPICAL BLOCK WIRE RUNS**

**16.01** Typical building runs are shown in Fig. 11 through 14.



**Fig. 11 — Drive Ring Run**



**Fig. 12 — Existing Strand Run**

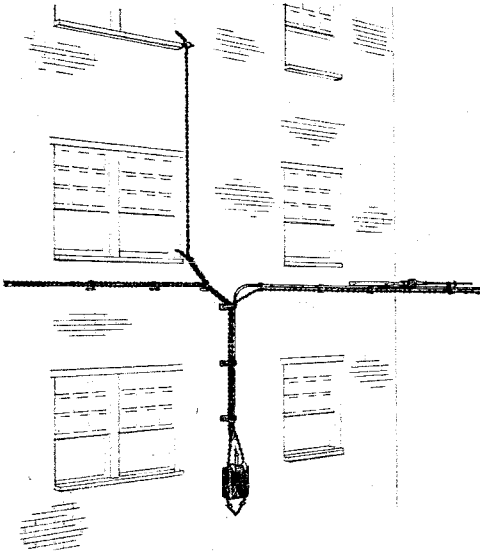


Fig. 13 — Drive Ring, Cable Clamp Ring, and Strand Run

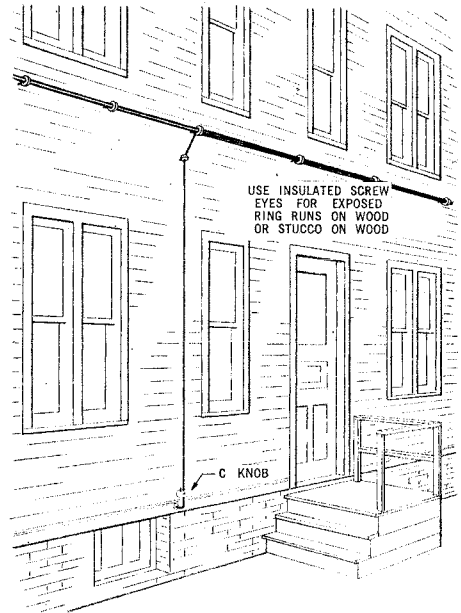


Fig. 14—Insulated Screw Eye Run (For Drop Wire Only)

**17. METHODS OF FASTENING DROP AND BLOCK WIRES INSIDE OF BUILDINGS**

**17.01** Drop wire runs between the point of entrance and the station protector should be kept as short as practicable.

**17.02** Space drop wire attachments 16 inches apart on runs between the point of entrance and the protector or connecting block.

**17.03** Where drop or block wires are extended from unexposed plant or where block wire is extended from the station side of a fuseless protector, the method of fastening between the

point of entrance and the connecting block or subscriber set is the same as for fastening station wire.

**18. DROP AND BLOCK WIRE ATTACHMENTS FOR INSIDE OF BUILDINGS**

**18.01** Typical drop and block wire runs within a building, some of the attachments to be used, and the spacing of attachments are shown in Fig. 15.



USE INSULATED ATTACHMENTS ONLY WHERE REQUIRED

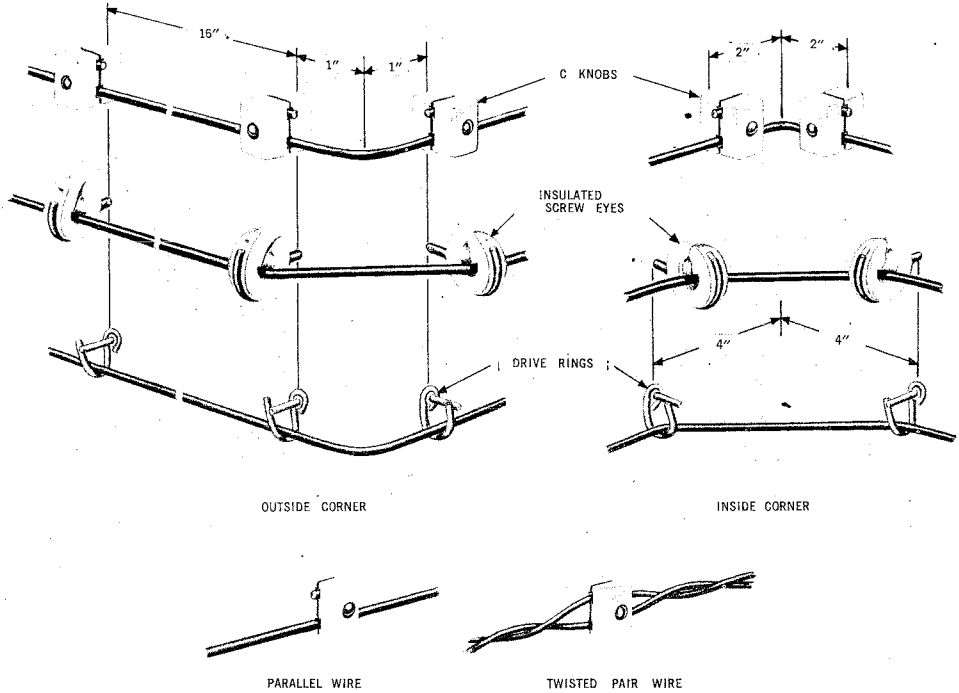


Fig. 15 — Fastening Drop and Block Wire Inside of Buildings

19. LAST ATTACHMENTS ON BUILDINGS (Fig. 16 and 17)

*Note:* The last attachments should be located within 18 inches of the building entrance hole.

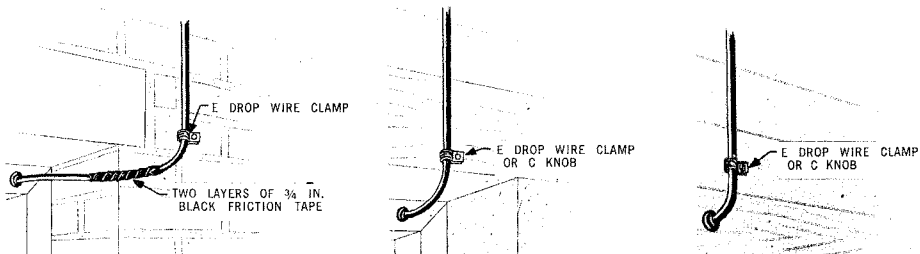


Fig. 16 — Last Attachment (Building Entrance Hole Slopes Upward from Outside)

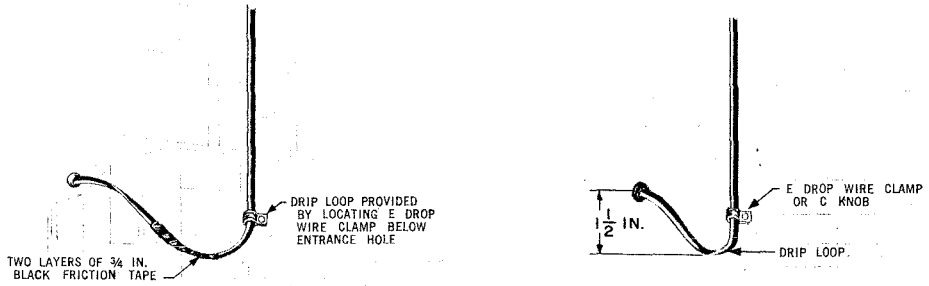


Fig. 17 — Last Attachment (Building Entrance Hole Does Not Slope Upward from Outside)

## 20. BUILDING ENTRANCE HOLES FOR DROP AND BLOCK WIRES

**20.01** Use plastic tubes at building entrance holes for drop wire where fused protection is required and the wire passes through a flammable surface. Place tube as shown in Fig. 18. Cut plastic tubes with a hack saw or diagonal pliers. Do not use split tubes at entrance holes.

**20.02** When drilling building entrance holes, consider the following:

- (a) Drill holes away from side where appearance is most important.
- (b) Slope holes upward from outside.
- (c) Use seams when drilling through masonry.
- (d) Exercise care to avoid splintering wood or cracking masonry or brick.
- (e) Drill clearance hole on all types of shingle siding.

**20.03** Sizes of building entrance holes for wires and plastic tubes are shown in Table D.

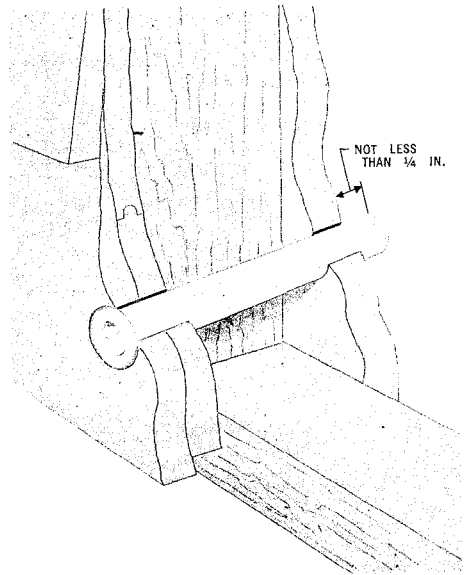


Fig. 18 — Placing Tube

**TABLE D**  
**SIZES OF BUILDING ENTRANCE HOLES**  
**FOR DROP AND BLOCK WIRES AND PLASTIC TUBES**

WIRE	ENTRANCE HOLES						
	PLASTIC TUBE REQUIRED			TUBE NOT REQUIRED			
	TUBE SIZE, INCH						
	3/8	1/2	5/8	HOLE SIZE, INCH			
	HOLE SIZE, INCH						
	1/2	5/8	3/4	3/8	1/2	5/8	3/4
TYPE	WIRE, QUANTITY						
Z block (bridle)				2	3	4	5
NC or NE drop	1	2	3	1	2	3	4

*Note:* When porcelain tubes are used, the size of the hole must be increased.

## DROP AND BLOCK WIRING

### PLACING DROP WIRE

### VOLTAGES LESS THAN 300 INVOLVED

#### 1. GENERAL

**1.01** This information was formerly covered in Section 625-400-205CA (G32.137.1) which is canceled.

**1.02** The procedures outlined herein apply specifically to the conditions usually encountered where the drop wire will not cross over trolley or trolley-bus contact wires or over power wires or power cables operating at 300 volts or more. The basic principles presented in this section should also be observed in those cases where conditions necessitate a departure from the usual procedures.

**1.03** The methods outlined herein are such that the drop wire is first attached to the building and is then raised for attachment to the pole or suspension strand by means of a handline to avoid accidents caused by tensioning the wire from a ladder at the building or vehicles striking the wire as it is being raised from the ground.

**1.04** Drop wire shall not be placed over secondary electric service wires if other means of installing the wire are practicable.

**1.05** Refer to Section 462-400-206CA for the method of placing a drop wire over trolley or trolley-bus contact wires or over power wires or power cables operating at 300 volts or more. The methods of lowering a drop wire, raising a lowered drop wire, and replacing a drop wire by pulling the new wire into the span as the old wire is pulled out of the span are covered in Sections 462-800-311CA and 462-800-312CA.

#### 2. PRECAUTIONS

**2.01** Obtain assistance before placing a drop wire over streets, highways, or elsewhere, if traffic, tree, or other conditions are such that one man cannot do the work safely.

**2.02** Insulating gloves shall be worn by all employees when performing all operations in which the handline or the drop wire may come in contact with power wires or power cables.

**2.03** The handline used for raising a drop wire under the conditions outlined in this section shall be free from metallic strands and shall preferably be dry. However, if weather conditions are such that it is impracticable to keep the handline dry, a wet handline may be used for placing drop wire over secondary electric service wires operating at less than 300 volts.

**2.04** In general, one 50-foot and one 100-foot 3/8-inch handline will be needed for the operations outlined in this section and Section 462-400-206. The handlines should be served at the ends to prevent unraveling.

**2.05** When it is necessary to carry a handline up a pole or ladder, double the end of the handline back on itself for a distance of approximately 1 foot and place this loop under the right or left side or back of the body belt or in such other position that the handline will be released readily if it is placed under tension while the employee is climbing the pole or ladder.

**2.06** Never release the drop wire supports from a wire span while working inside the angle formed by the wire.

**2.07** Avoid working from a ladder placed against a building with the side rails crossing a wire run or in any other position where movement of the wire, due to loosening of the attachments, would cause an accident.

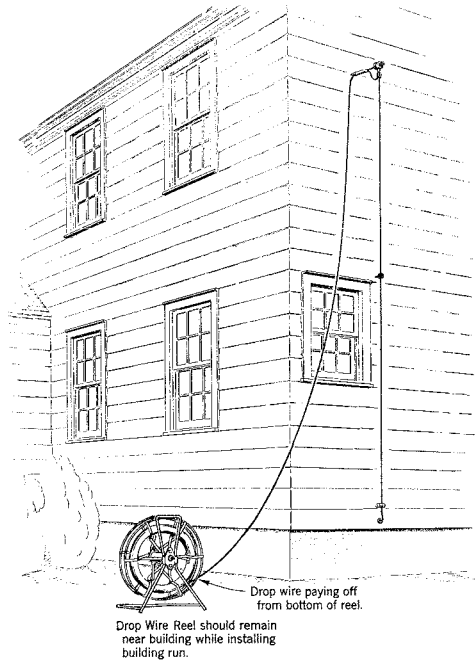
**2.08** When a drop wire is to be attached to a span clamp, place the foot of the extension ladder on the field side of the suspension strand and not in the street or highway. If there is no street or highway adjacent to the span clamp,

## SECTION 462-400-205CA

place the ladder preferably against the opposite side of the strand from the drop wire run to the building.

**2.09** If conditions are such that the handline, or the drop wire to which it is attached, may become disengaged from a drive hook or crossarm or may slide along the strand or guard arm while doing the work outlined in this section, the handline or drop wire shall be enclosed with a temporary guide loop. This loop shall consist of a short length of wire or houseline placed over the handline or drop wire with the ends of the guide securely tied as follows:

- **Drive Hook:** Tie one end to the vertical portion of the drive hook and lash the other end to the pole.
- **Crossarm:** Tie the ends to adjacent pins or insulators.
- **Guard Arm:** Tie the ends to the guard arm on each side of the handline or drop wire.
- **Strand:** Tie the ends to the strand or the strand and lashed cable on each side of the handline or drop wire, or place the handline or drop wire through the hook of a B span clamp.



**Fig. 1 — Drop Wire Attached to Building**

### 3. PLACING WIRE OVER STREET OR HIGHWAY — NO TREE INTERFERENCE

**3.01** Where a drop wire to be placed over a street or highway will not cross over trolley or trolley-bus contact wires or over power wires or power cables operating at 300 volts or more, and there is no tree interference, place the wire in accordance with the operations outlined below.

**Caution:** Before proceeding with the following operations, fasten the inner end of the coil of drop wire securely to one of the springless spokes of the drop wire reel.

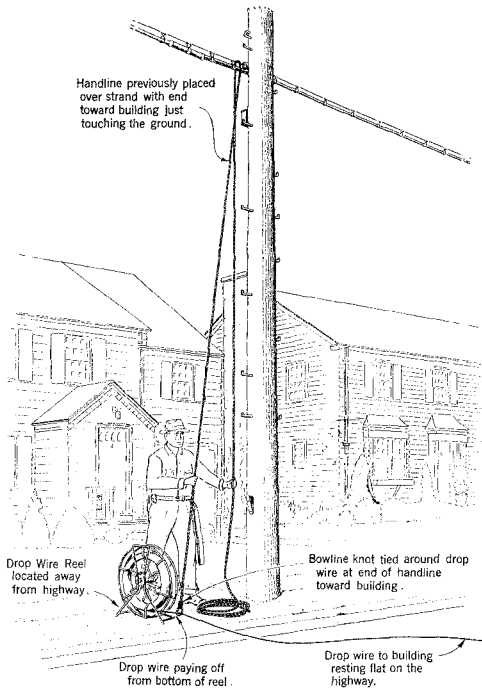
(1) Install the first building attachment, attach the drop wire to this support, and complete the building run in a standard manner. In doing this work, keep the drop wire reel on the ground near the building to avoid accidents resulting from vehicles striking the wire or pedestrians tripping on it. (See Fig. 1.)

(2) Place a handline over the strand, guard arm, drive hook, or crossarm so that both ends reach the ground, with no excess length in that portion of the handline toward the building. If practicable, the handline may be formed into a coil at one end and thrown over the strand. After the handline has been placed, tie it to the base of the pole or the lower rungs of the ladder to avoid interference with pedestrians or vehicles. If it is necessary to climb the pole or ladder to place the handline, install any drop wire support that is needed, otherwise, place this support when the pole is climbed to attach the drop wire as covered in Step 9.

(3) Roll or carry the drop wire reel from the building to the building side of the street or highway, paying out the wire along the ground with sufficient slack to ensure that the wire rests flat on the ground.

(4) When no traffic is approaching, roll or carry the drop wire reel across the street or highway to the previously placed handline, paying out the wire so that it rests flat on the ground. If a metal or hard rubber-tired vehicle passes over the wire, carry the drop wire reel back to the building side of the highway and pull the wire from the highway. Inspect the wire for possible injury and replace any portions that are found to be damaged.

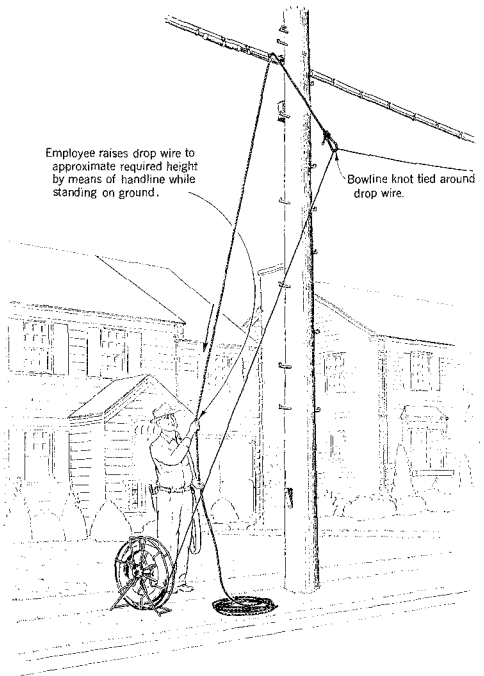
(5) Release the handline from the base of the pole or ladder and tie a bowline knot in the end of the handline toward the building and around the drop wire at the reel as shown in Fig. 2, being careful not to raise the wire above the highway. Wind any excess length of drop wire on the reel.



**Fig. 2 — Bowline Knot Placed around Drop Wire**

(6) Set the brake of the drop wire reel so that when the wire is raised by the handline there will be sufficient tension in the wire to enable it to be pulled up to the approximate required height in the span over the street or highway.

(7) After checking to make sure that the drop wire reel is in a stable position and that its brake is properly set, grasp the free end of the handline and, when no vehicles or pedestrians are approaching, raise the drop wire as shown in Fig. 3. If it is necessary to remove excess slack from the wire span as it is being raised, pull the wire feeding from the reel and wind the excess length of wire on the reel.



**Fig. 3 — Raising Drop Wire**

(8) After the drop wire has been raised to the approximate required height, lash the handline near the base of the pole or, at a span clamp, to the lower rungs of the ladder (see Fig. 4).

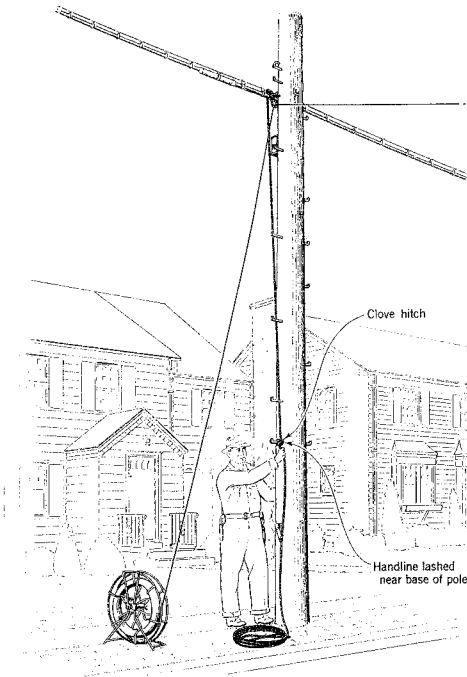


Fig. 4 – Drop Wire Raised to Approximate Height

(9) Climb the pole or, if at a span clamp, the ladder, and attach the drop wire to the pole or strand in a standard manner without removing the handline from the drop wire. When attaching the drop wire to a span clamp, bear in mind that the strand is forced out of line by the ladder resting against it and make any adjustments that are necessary to avoid excessive tension in the wire span when the employee is working from the ladder and also to ensure proper sag and clearance after removal of the ladder.

(10) Remove the handline from the drop wire. Cut the wire, leaving a sufficient length to reach the terminating point, and complete the connection in a standard manner.

#### 4. PLACING WIRE OVER STREET OR HIGHWAY – TREE INTERFERENCE

4.01 The placing of drop wire through trees shall be avoided whenever practicable. However, if trees cannot be avoided, the method outlined in 3.01 shall be modified as follows:

**Caution:** Before proceeding with the following operations, fasten the inner end of the coil of drop wire securely to one of the springless spokes of the drop wire reel.

(a) Procedure where tree is located on the same side of the street or highway as the building.

(1) Place the drop wire reel on the side of the tree toward the pole line. If the tree overhangs the street, the reel shall not be placed in the street unless it is properly guarded by means of the telephone company car or otherwise.

(2) Place the handline among the branches of the tree in the desired location for the drop wire, and pull the wire into position among the branches. A wire raising tool may be used to facilitate this operation.

**Caution:** The handline and drop wire shall not overhang the street unless they are properly guarded. If practicable, park the telephone company car so that it will shield the handline and the drop wire.

(3) Attach the drop wire to the building, as covered in 3.01(1), making sure that the wire rests flat on the ground between the tree and the building.

(4) Complete the wire run to the pole or to the span clamp as covered in 3.01 (2) to (10) inclusive.

(b) Procedure where tree is located in the immediate vicinity of the pole or span clamp.

(1) When placing the handline over the strand, guard arm, drive hook, or crossarm, locate it among the branches of the tree as illustrated in Fig. 5, in order that the drop wire may be raised to the

proper position. A wire raising tool may be used to facilitate this operation. After the handline has been placed, tie it to the base of the pole or the lower rungs of the ladder to avoid interference with pedestrians or vehicles.

**Caution:** *The handline shall not overhang the street unless it is properly guarded. If practicable, park the telephone company car so that it will shield the handline.*

(2) Proceed as covered in 3.01 or 4.01 (a) (1), (2), (3), (4), depending on the conditions, except that the wire shall be raised at the pole or strand end of the span as follows:

(a) With the drop wire crossing the street and resting flat on the ground, remove sufficient wire from the drop wire reel to reach the terminating point and cut the wire.

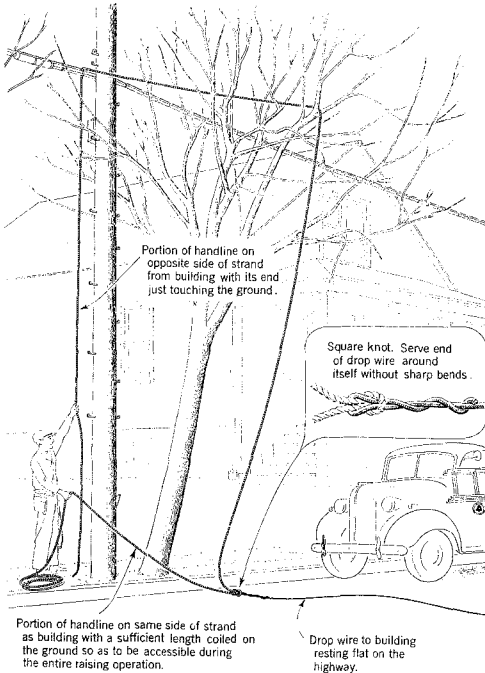


Fig. 5 – Drop Wire Tied to Handline

(b) Tie the end of the drop wire to the handline as shown in Fig. 5 at a point in that portion of the handline toward the building which will permit the employee to have access to both ends of the handline from his position on the ground during the entire raising operation.

**Note:** If the handline has been placed over a drive hook or other support on which the square knot would snag, fasten the wire to the handline as shown in Fig. 6.

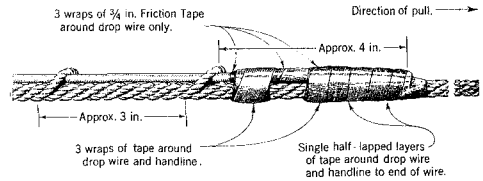


Fig. 6 – Alternate Tie to Prevent Snagging

(c) When no vehicles or pedestrians are approaching, raise the drop wire by pulling that portion of the handline on the opposite side of the strand from the building. The portion of the handline toward the building should pass through employee's hand as shown in Fig. 7 in order that he may be able to pull the handline in either direction to work the drop wire among the branches of the tree or to pull the wire to the ground quickly if necessary.

(d) After the drop wire has been raised to the approximate required height, tie the handline to the base of the pole, or, if at a span clamp, to the lower rungs of the ladder and proceed as outlined in 3.01(9) and (10).

**5. PLACING WIRE ELSEWHERE THAN OVER STREET OR HIGHWAY**

5.01 When placing a drop wire elsewhere than over a street or highway, follow the methods outlined in Part 3 or 4 if these procedures are necessary in order to raise the wire safely, such as when spanning from one building to another. Otherwise, place the wire as follows:



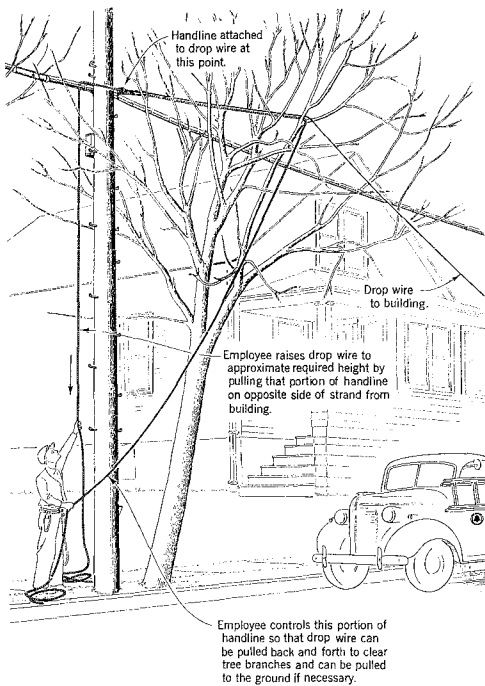


Fig. 7 — Raising Drop Wire

**Caution:** Before proceeding with the following operations, fasten the inner end of the coil of drop wire securely to one of the springless spokes of the drop wire wheel.

- (1) Install the first building attachment and complete the wire run on the building, keeping the drop wire reel near the building to prevent accidents resulting from vehicles striking the wire or pedestrians tripping on it.

**Note:** If obstructions are encountered between the building and the pole or span clamp, locate the drop wire reel on the pole line side of the obstruction, place the wire over or through the obstruction and then attach the wire to the building, making sure that the wire rests flat on the ground between the obstruction and the building.

- (2) Roll or carry the drop wire reel from the building to the pole or span clamp location, paying out the wire so that it rests flat on the ground.

- (3) Tie a bowline knot in one end of the handline around the drop wire at the reel. The length of the handline shall be greater than the distance from the ground to the drop wire attachment point.

- (4) Set the brake of the drop wire reel so that when the wire is raised by the handline there will be sufficient tension in the wire to enable it to be pulled up to the approximate required height in the span.

- (5) Loop the other end of the handline under the body belt as described in 2.05 and climb the pole or, if at a span clamp, the ladder.

- (6) Place the handline over the strand, guard arm, drive hook, or crossarm from the side toward the building.

- (7) Raise the drop wire to the approximate required height by pulling the handline over the strand or other support and then lash the handline to the pole or strand.

- (8) Attach the drop wire to the pole or strand in a standard manner without removing the handline. When attaching the drop wire to a span clamp, bear in mind that the suspension strand is forced out of line by the ladder resting against it and make any adjustments that are necessary to avoid excessive tension in the wire span when the employee is working from the ladder and also to ensure proper sag and clearance after removal of the ladder. A suggested method of accomplishing this is to determine the position of the drop wire clamp on the drop wire with the strand displaced, then to estimate the location the strand will occupy when the ladder is removed and adjust the location of the drop wire accordingly. To estimate the final position of the strand, it will be helpful if sights are taken towards and along adjacent spans where no corners are involved, and measurement is made of the amount of displacement caused by the ladder. If there is any doubt as to the exact distance the clamp

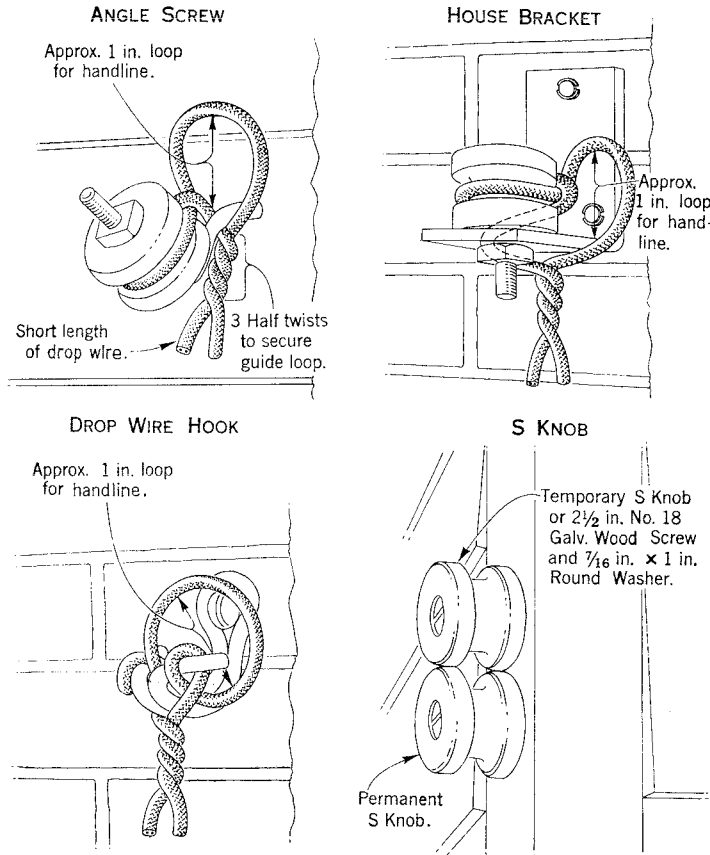
should be moved, provide extra length in the drop wire span, rather than less, if clearance requirements can be met, as this will result in a lower tension in the drop wire.

(9) Remove the handline from the drop wire.

Cut the wire, leaving a sufficient length to reach the terminating point, and complete the connection in a standard manner.

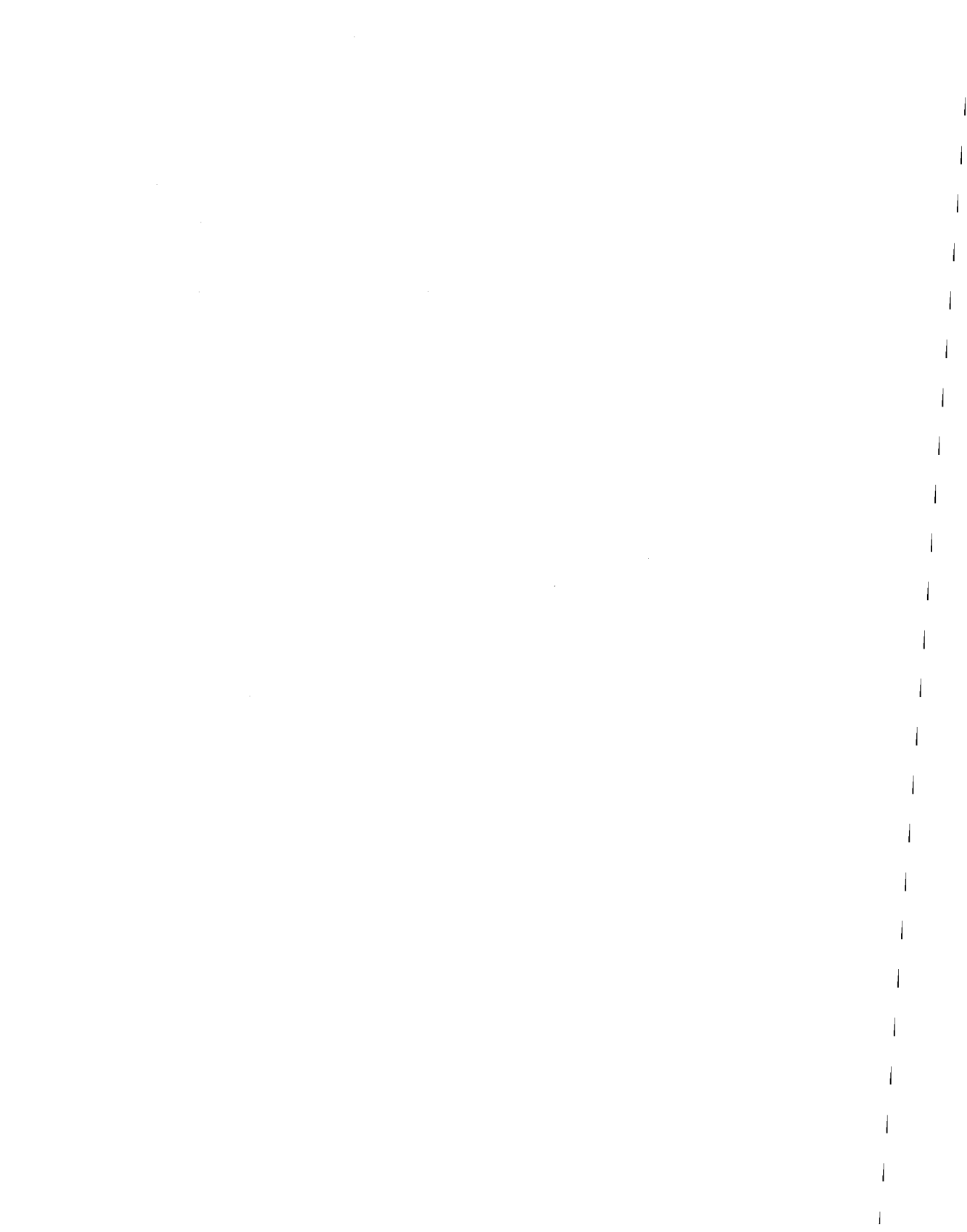
5.02 Place a drop wire between two buildings in the same manner as for a pole-to-building

run, providing as much sag as practicable in the wire span. A temporary guide loop, such as shown in Fig. 8, should be installed on the first building attachment at which the wire span is to be raised, to prevent accidental disengagement of the handline from the building attachment. Support the tension in the wire by lashing the handline, which was used in raising the wire, to a substantial and secure support near the base of the building and then install the second drop wire clamp of the span.



*Note:* Where Multiple Drop Wire is being installed on a drop wire hook, a snatch block may be used to support the wire instead of the method shown above. The snatch block may be attached to the drop wire hook by means of a 15/16 in. construction chain, using the links or one of the rings on either end of the chain. Care should be taken to assure that the chain link, chain ring or equivalent ring, is looped securely around the drop wire hook.

Fig. 8 – Temporary Guide Loop



## DROP AND BLOCK WIRING

### PLACING DROP WIRE

### VOLTAGES OF 300 TO 750 INVOLVED

#### 1. GENERAL

**1.01** This information was formerly covered in Section 625-400-206CA (G32.137.2) which is canceled.

**1.02** This section covers the method of placing drop wire under the conditions usually encountered where the drop wire will cross over trolley or trolley-bus contact wires or over power wires or power cables operating at 300 to 750 volts. The basic principles presented in this section should also be observed in those cases where conditions necessitate a departure from the usual procedure.

*Note:* Under no condition shall a drop wire be placed over power wires or power cables operating at more than 750 volts. Such cases shall be referred through the lines of organization to the plant engineer for disposition.

**1.03** The method outlined herein is such that the drop wire is first attached to the building and is then placed over the trolley contact or power wires or power cables by means of a handline while the employees remain on the ground and so perform the work that the drop wire does not come in contact with the power circuits during the entire placing operation. This method is also intended to avoid the possibility of accidents caused by tensioning the wire from a ladder at the building or vehicles striking the wire or the handline as it is being raised from the ground.

**1.04** Drop wire shall not be placed over trolley or trolley-bus contact wires, or over power cables operating at 300 to 750 volts, if other means of installing the wire are practicable.

**1.05** Drop wire shall not be attached to a span clamp under the conditions covered by this section unless the span clamp is accessible from the pole.

**1.06** Refer to Section 462-400-205CA for the methods of placing a drop wire where no trolley or trolley-bus contact wires or power wires or power cables operating at 300 volts or more are involved. The methods of lowering a drop wire, raising a lowered drop wire, and replacing a drop wire by pulling the new wire into the span as the old wire is pulled out of the span are covered in Sections 462-800-311CA and 462-800-312CA.

#### 2. PRECAUTIONS

**2.01** In general, two men shall be employed when raising a drop wire over trolley or trolley-bus contact wires, or over power wires or power cables operating at 300 to 750 volts. Obtain additional assistance before raising a drop wire over streets, highways, or elsewhere if traffic, tree, or other conditions are such that two men cannot do the work safely.

**2.02** Insulating gloves shall be worn when placing a drop wire over trolley or trolley-bus contact wires, or over power wires or power cables and until the drop wire has been attached at both ends of the crossing span in a standard manner.

**2.03** The handline used for raising a drop wire under the conditions outlined in this section shall be free from metallic strands and shall be dry. A wet handline must not be used in the vicinity of power circuits operating at 300 volts or more, except as indicated in the following note.

*Note:* When it is necessary to maintain service or establish emergency service during rainstorms, a wet handline may be used over trolley or trolley-bus contact wires and other power circuits operating at 300 to 750 volts, provided that insulating gloves, rubber boots, and rubber raincoats are worn.

**2.04** When it is necessary to carry a handline up a pole or ladder, double the end of the handline back on itself for a distance of approximately 1 foot and place this loop under the right or left side or back of the body belt or in such other position that the handline will be released readily if it is placed under tension while the employee is climbing the pole or ladder. The same procedure shall be followed when carrying a wire up a ladder.

**2.05** Never release the drop wire supports from a wire span while working inside the angle formed by the wire.

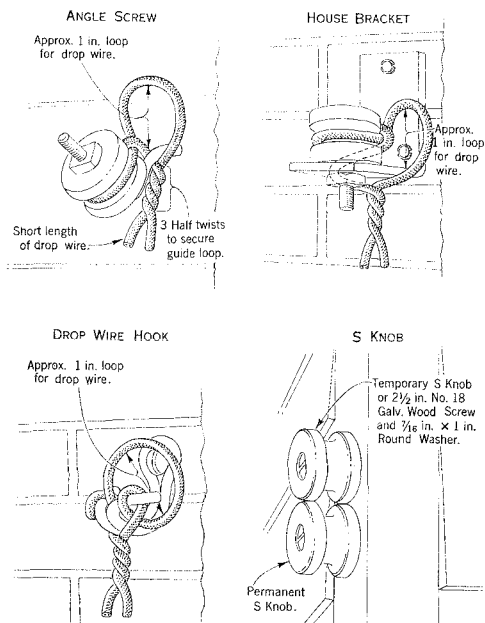
**2.06** Avoid working from a ladder placed against a building with the side rails crossing a wire run or in any other position where movement of the wire, due to loosening of the attachments, would cause an accident.

**2.07** If conditions are such that the handline, or the drop wire to which it is attached, may become disengaged from a drive hook or crossarm or may slide along the strand or guard arm while doing the work outlined in this section, the handline or drop wire shall be enclosed with a temporary guide loop. This loop shall consist of a short length of wire or houseline placed over the handline or drop wire with the ends of the guide securely tied as follows:

- Drive Hooks: Tie one end to the vertical portion of the drive hook and lash the other end to the pole.
- Crossarm: Tie the ends to adjacent pins or insulators.
- Guard Arm: Tie the ends to the guard arm on each side of the handline or drop wire.
- Strand: Tie the ends to the strand or the strand and lashed cable on each side of the handline or drop wire, or place the handline or drop wire through the hook of a B span clamp.

### 3. PLACING WIRE OVER TROLLEY CONTACT OR POWER WIRES OR POWER CABLES

**Caution:** When it is necessary to place a drop wire over trolley or trolley-bus contact wires or over power wires or power cables, the crossing span shall be placed independently of any additional spans of wire that may be required to establish service.



**Fig. 1 — Temporary Guide Loop**

**Note:** Where Z Multiple Drop Wire is being installed on a drop wire hook, a snatch block may be used to support the wire instead of the method shown above. The snatch block may be attached to the drop wire hook by means of a 15/16 in. construction chain, using the links or one of the rings on either end of the chain. Care should be taken to assure that the chain link, chain ring or equivalent ring, is looped securely around the drop wire hook.

**3.01** Place the drop wire over trolley or trolley-bus contact wires or over power wires or power cables as outlined below:

#### Man No. 1

- (1) Install the first building attachment or, if the drop wire is to be attached to a pole on the building side of the trolley contact or power wires or power cables, the pole attachment.

- (2) Attach a temporary guide loop to the first building attachment such as shown in Fig. 1, to prevent the drop wire from becoming accidentally disengaged from the building attachment during the placing operations.

**Note:** If the drop wire is to be attached to a pole between the trolley contact or power wires or power cables and the building, place the temporary guide loop on the pole attachment instead of at the building.

- (3) Place the drop wire reel, equipped with a coil of new wire, near the foot of the ladder on the side away from the wire span and in a stable position.

**Caution:** Fasten the inner end of the coil of drop wire securely to one of the spokes of the drop wire reel.

- (4) Set the brake of the drop wire reel so that when the wire is pulled by the handline there will be sufficient tension in the wire to prevent it from sagging onto the trolley contact or power wires or power cables.

- (5) With the wire paying off from the bottom of the reel, pass the wire over the first building attachment and through the temporary guide loop at this attachment until the end of the wire reaches the ground.

- (6) Man No. 2 lashes one end of the handline to the base of the pole. The handline shall be of a sufficient length to extend vertically from the ground to the strand or pole attachment and then horizontally at least 25 feet beyond the trolley contact or power wires or power cables.

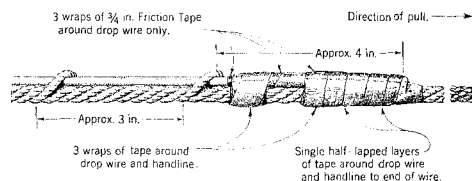
- (7) Man No. 1 goes into the street or highway to control traffic, assisted by the police if necessary.

- (8) Man No. 2 places the free end of the handline over the strand, guard arm, drive hook, or crossarm. If practicable, the handline may be formed into a coil at one end and thrown over the strand.

- (9) Standing on the ground, Man No. 2 now throws the free end of the handline over the trolley contact or power wires or power cables and ties this end of the handline to the

end of the drop wire by means of a square knot, serving the end of the wire around itself without sharp bends. If the handline has been placed over a drive hook or other support on which the square knot would snag, fasten the handline to the wire as shown in Fig. 2.

**Note:** If a tree is involved, place the handline among the branches of the tree in the desired location for the drop wire. A wire raising tool may be used to facilitate this operation.



**Fig. 2 — Alternate Tie to Prevent Snagging**

- (10) Man No. 2 next reels up all slack in the handline and drop wire onto the drop wire reel, thereby raising the handline clear of the trolley contact or power wires or power cables. If the end of the drop wire attached to the handline would be pulled back through the temporary guide loop at the first building attachment in this operation, Man No. 2 shall stop reeling up slack, make sure that the drop wire reel is in a stable position and that its brake is properly set, return to the pole end of handline, and pull the remaining slack out of the handline and wire span so that the handline is clear of the power circuits. He then reties the handline to the pole and returns to the drop wire reel.
- (11) Man No. 1 who has been in the street or highway directing traffic during operations (8) to (10), inclusive, goes to the pole and pulls the handline, observing carefully to see that there is sufficient tension in the wire paying off the drop wire reel to prevent the wire from sagging onto the power circuits. Man No. 2 controls the action of the drop wire reel to ensure that there is adequate tension in the wire as it is pulled from the reel.
- (12) After Man No. 1 has pulled a sufficient length of drop wire over the strand, guard

## SECTION 462-400-206CA

arm, drive hook, or crossarm for terminating or splicing purposes, he shall lash the handline to the base of the pole.

*Note:* If the handline or drop wire catches while it is being pulled over the strand, guard arm, drive hook, or crossarm, Man No. 2 remains at the drop wire reel and keeps the wire under sufficient tension to prevent it from sagging onto the power circuits. Man No. 1 lashes the handline to the base of the pole and proceeds to free the handline or drop wire.

(13) Man No. 1 crosses the highway to building and, while Man No. 2 maintains tension in the wire span, Man No. 1 fastens the drop wire to the first building attachment with a drop wire clamp and then removes the temporary guide loop.

*Note:* While Man No. 1 is fastening the drop wire to the first building attachment, Man No. 2 shall not attempt to maintain any more tension in the wire than is necessary to prevent it from sagging onto the trolley contact or power wires or power cables. The proper tensioning of the drop wire shall be done from the pole attachment side of the power circuits.

(14) Both men now go to the pole and, while Man No. 1 maintains the proper tension in the handline, Man No. 2 climbs the pole, fastens the drop wire in a standard manner and then removes the handline.

## DROP AND BLOCK WIRING POLE-TO-BUILDING AND POLE-TO-POLE RUNS

### 1. GENERAL

- 1.01** This information was formerly covered in Section 625-400-211CA (G32.125.1) which is canceled.
- 1.02** This section covers the methods of making pole-to-building and pole-to-pole runs of drop wire. Drops from open wire lines are covered in another section.
- 1.03** The requirements applying to clearances between telephone wires and foreign wires and equipment, clearances above ground, and climbing space on jointly used poles shall be observed in running drop wires.
- 1.04** Stringing operations related to the procedures described herein are covered in other sections.
- 1.05** Drop wire should be strung to normal stringing sags unless ground clearances make it necessary to use the minimum stringing sags as outlined in the section entitled Stringing Sags for Drop Wires.

### 2. DISTRIBUTING DROPS FROM TERMINAL POLES

- 2.01** At Terminal Poles Not Requiring Guard Arms: Distribute drop wires from drive hooks placed on the face or back of poles. On pole-to-building spans, use drive hooks located above the suspension strand. On spans from pole-to-pole and from pole-to-span clamp, use the drive hook located below the cable. Pass the drop wire through the drive hook only in case no sharp bends will be placed in the wire.
- 2.02** The wiring arrangements for strand mounted and pole mounted terminals are indicated in Fig. 1, 2, and 3.
- 2.03** Run wiring on pole in a neat manner and with enough slack to avoid sharp bends at fixtures. Where drop wire passes through a drive hook, provide slack in the form of a smooth curve.

- 2.04** At Terminal Poles Requiring Guard Arms: Follow the procedures covered in the section entitled Pole and Guard Arm Attachments.

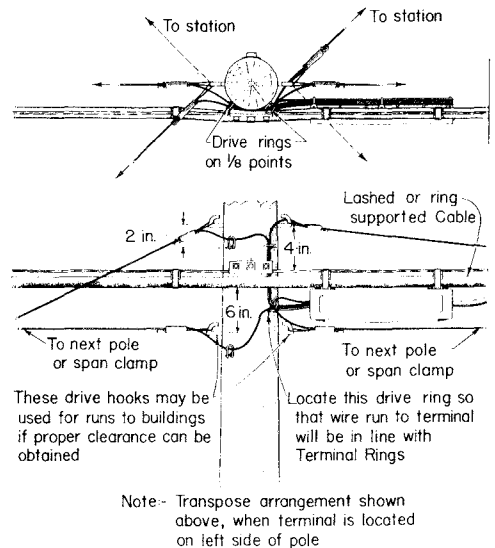
### 3. DROP WIRE RUNS ALONG THE LEAD

#### General

- 3.01** For transmission and maintenance reasons, observe local instructions as to the maximum number of drops permissible and limit the length of drop wire runs to 500 feet.
- 3.02** Attach drop wire runs to poles along the lead by means of drive hooks. However, existing pole brackets may be used if they are located as specified for drive hooks.

#### Lead Carrying Aerial Cable

- 3.03** Run drop wire below the cable as shown in Fig. 4.



**Fig. 1 — Strand Mounted Terminal**



SECTION 462-400-211CA

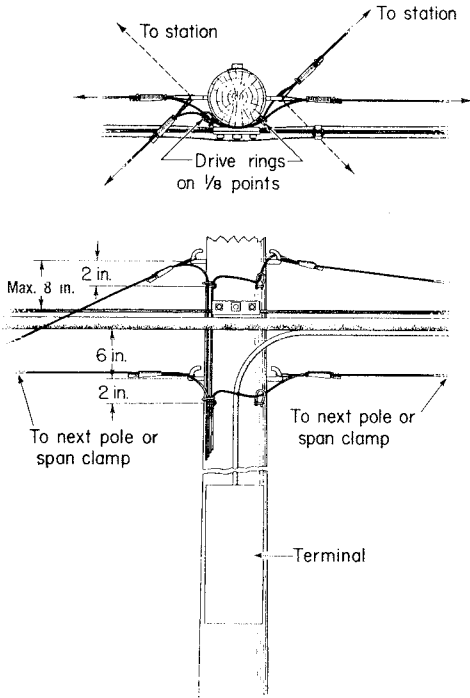


Fig. 2 — Terminal Mounted on Cable Side of Pole

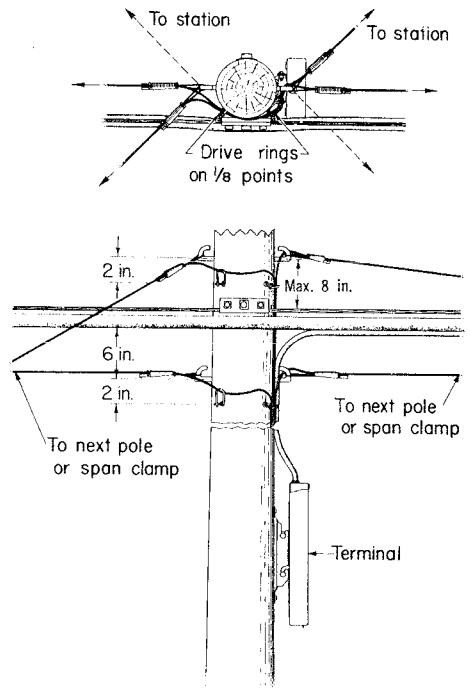


Fig. 3 — Terminal Mounted on Face or Back of Pole

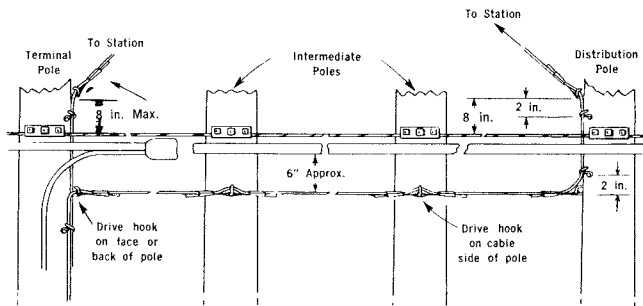
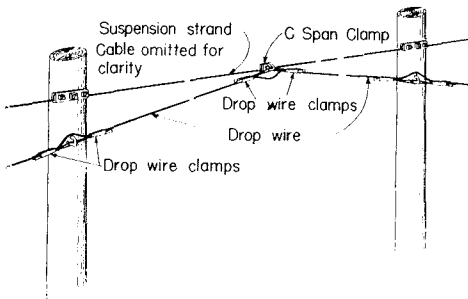


Fig. 4

Fig. 4 — Drop Wire Run Along Lead Carrying Cable

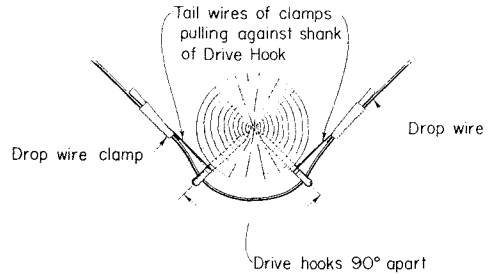


**Fig. 5 – Drop Wire on Intermediate Strand Pickup**

**3.04** Where required ground clearances in the span can not be obtained with wire strung at a minimum sag, then one or more intermediate strand pickups can be used to reduce wire sag as illustrated in Fig. 5.

**3.05** Where the procedure indicated in 3.04 fails to provide the required ground clearance, then the drop wire may be placed above the suspension strand. Locate drive hooks at such height that the drop wire does not whip against the strand or cable and proper joint use clearances are obtained.

**3.06** On straight line poles or inside corner poles where the pull of the wire is away from the pole, use a single drive hook to support the drop wire.



**Fig. 6 – Turning Outside Corner**

**3.07** On outside corner poles where the angle will cause the drop wire to rub against the pole, use two drive hooks to support the wire as shown in Fig. 6.

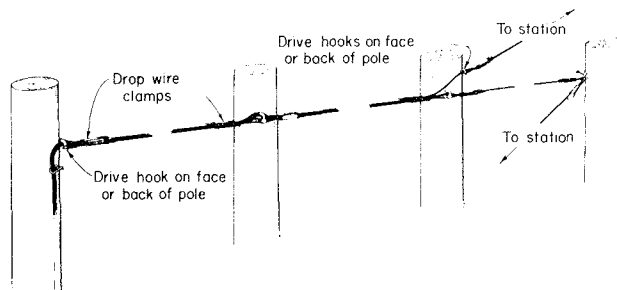
**Lead Not Carrying Aerial Cable**

**3.08** Run drop wires as illustrated in Fig. 7.

**Distributing Wires from Pole Other Than Terminal Pole**

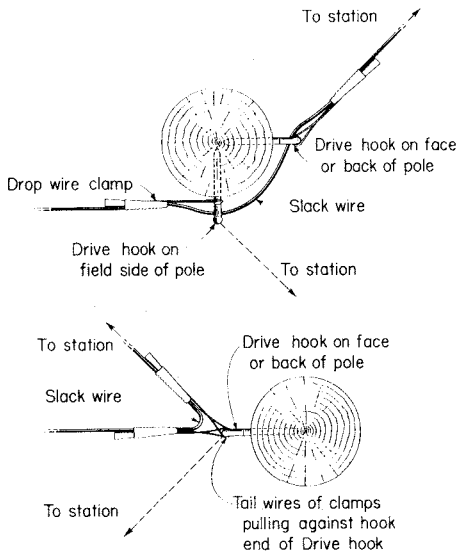
**3.09** Distribute drop wires as illustrated in Fig. 8.

**3.10** On jointly used poles or poles which are likely to become jointly used, drop wires may be distributed from guard arm hooks where a guard arm is required to provide proper climbing space.



**Fig. 7 – Drop Wire Run Along Lead Not Carrying Cable**

SECTION 462-400-211CA

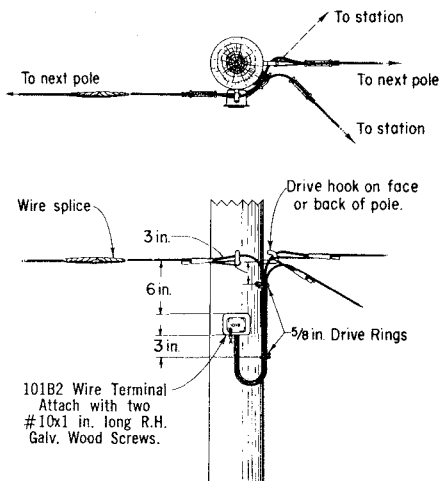


**Fig. 8 — Distributing Wires from Pole Other Than Terminal Pole**

**4. PARTY-LINE TAPS ON DROP WIRE RUNS ALONG THE LEAD**

**Tap at Intermediate Points**

**4.01** To make an intermediate party tap along the lead, proceed as follows:



**Fig. 9 — Complete Party Line Tap**

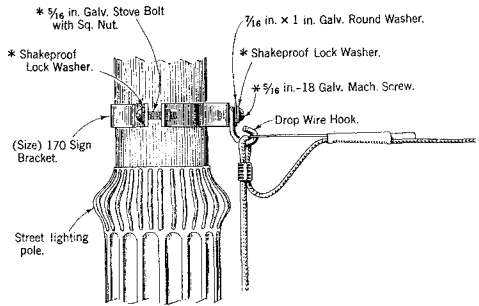
- (1) Install a 101B2 wire terminal on the pole directly below the drive hook.
- (2) Place a second drive hook on the face or back of the pole at the same level as the existing hook supporting the through drop wire.
- (3) After testing to make sure the line is not in use, cut the through drop wire about 2 feet from the first drive hook. The drop wire puller can be used to hold the wire before the cut is made.
- (4) Splice a piece of drop wire to the short end of the through drop wire supported by the drop wire puller. Install a drop wire clamp on the spliced wire and place it on the new drive hook on the face or back of the pole.
- (5) Place drive rings on pole and run the wire through them and terminate the two ends of the through drop wire on the binding posts of the wire terminal. Terminate the bridging drop wire in the wire terminal on top of the through wire connections. The complete party line tap is illustrated in Fig. 9.

**Tap at End of Run**

**4.02** If the drop wire run along the lead is to be extended to an additional station, proceed as follows:

- (1) Place a 101B2 wire terminal on the pole and cut the existing subscriber circuit into it.
- (2) Terminate the drop wire extension in the 101B2 wire terminal to make the bridging connection.
- (3) Splice out the existing drop loop and terminate it in the wire terminal. The complete arrangements are similar to those shown in Fig. 9.

**4.03** In disconnecting a party line tap, lift its termination in the 101B2 wire terminal. Tag and cap the free end of the wire and bend it back upon itself about the lower ring and tape securely to the supporting wire.



\* These items are furnished with the Sign Bracket.

**Fig. 10 — Attachment to Type 170 Sign Bracket**

**5. RUNNING DROP WIRE PAST CABLE TERMINALS**

**5.01** Avoid drop wire runs past a cable terminal by endeavoring to obtain a reassignment to a nearer terminal.

**5.02** Where a disconnected drop wire passing a terminal is to be reused, obtain an assignment to the nearer terminal if practicable.

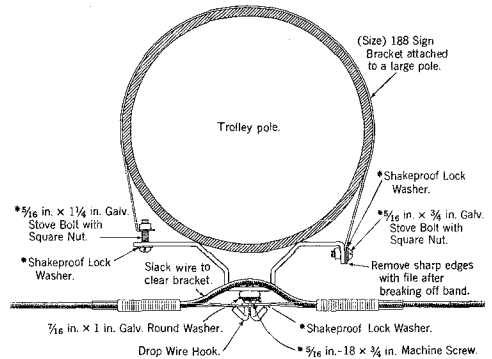
**6. ATTACHING DROP WIRE TO METAL TROLLEY OR STREET LIGHTING POLES**

**6.01** Drop wire attachments to metal trolley, traffic signaling, or street lighting poles should be avoided. However, if it is unavoidable, refer the case to your supervisor for specific approval before attachments are made.

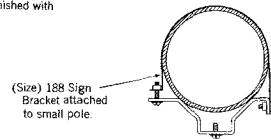
**Installation**

**6.02** Attach drop wire to metal street lighting, traffic signaling, or trolley pole by means of a drop wire hook fastened to a type 170 or 188 sign bracket as illustrated in Fig. 10 and 11. The diameter of the pole determines the type of sign bracket to be used, as follows:

<u>Diameter of Pole</u>	<u>Type of Sign Bracket</u>
1-7/8 to 3 inches	2-170
3 to 4 inches	3-170
4 to 5 inches	4-170



\* These items are furnished with the sign bracket.



**Fig. 11 — Attachment to Type 188 Sign Bracket**

<u>Diameter of Pole</u>	<u>Type of Sign Bracket</u>
5 to 8 inches	6-188
8 to 12 inches	10-188

**6.03** The principal points to be observed in installing the type 188 sign bracket are as follows:

- (1) Attach the perforated band to the straight end of the bracket leaving the nut at the end of the 1-1/4 inch stove bolt.
- (2) Place the bracket against the pole, wrap the band snugly around the pole and attach the free end of the bracket, inserting the 3/4-inch stove bolt in the nearest hole.
- (3) Tighten the 3/4-inch bolt securely and then tighten the 1-1/4 inch bolt as much as possible without stripping the threads or bending the bracket excessively. If the bracket is not secure after the 1-1/4 inch bolt has been tightened, back off the nut to the end of the bolt,

**SECTION 462-400-211CA**

relocate the 3/4-inch bolt to the next hole to take up the slack in the band and then re-tighten the 1-1/4 inch bolt.

(4) Remove the excess length of the band by bending it back and forth until it breaks at

the bracket. Remove sharp edges of break with a file.

**6.04** Only one drop wire shall be attached to a sign bracket.

## DROP AND BLOCK WIRING

### SEPARATION AND MECHANICAL PROTECTION

CONTENTS	PAGE
1. GENERAL . . . . .	243
2. GENERAL PRECAUTIONS . . . . .	243
3. DEFINITION OF TERMS . . . . .	243
4. SEPARATIONS . . . . .	243
5. MECHANICAL PROTECTION . . . . .	244

#### 1. GENERAL

1.01 This section specifies minimum separations required between foreign conductors and telephone wiring in or on buildings and in spans to buildings. It also describes mechanical protection required between telephone wiring and pipes, gutters, masonry, etc.

1.02 This section is reissued to include separation requirements originally contained in Section 461-200-201. Since this is a general revision, arrows ordinarily used to indicate changes have been omitted.

1.03 In general, separations are required for electrical reasons. However, uncovered steam and hot water pipes, stationary metal gratings, etc, also must be considered because of excessive heat or abrasion.

#### 2. GENERAL PRECAUTIONS

2.01 All wire installed in explosive atmospheres shall be placed in accordance with the instructions pertaining to that equipment.

2.02 Wire shall not be placed in pipe or conduit containing electric light and power wires or cables. Wires shall not be placed in the same outlet box or junction box, unless separated from the electric light and power wires by a suitable insulating partition.

2.03 Whenever practicable, avoid running telephone wire in the same conduit, molding, or runway with signal circuits which are operated by battery or from a step-down transformer. Strict adherence to this recommendation will minimize the possibility of interference by either or both parties during placing or maintenance activities.

2.04 Cold water pipes sweat under certain conditions; therefore, cross wire *over* rather than under the pipes.

#### 3. DEFINITION OF TERMS

3.01 The following definitions are for terms used in Tables A, B, and C:

- Bare Wire—A conductor having no covering or insulation whatsoever.
- Open Wiring—A wiring method using cleats, knobs, tubes, and flexible tubing for the protection and support of insulated conductors run in or on buildings, and not concealed by the building structure.
- Service Drop—The overhead service conductors between the last pole or other aerial support and the first attachment to the building.
- Nonmetallic Sheathed Cable—An assembly of two or more insulated conductors having an outer sheath of moisture resistant, flame retardant, nonmetallic material.

#### 4. SEPARATIONS



*The separations shown in Tables A, B, and C are minimum requirements. Greater separations shall be provided where readily obtainable.*

4.01 Separations specified in Tables A, B, and C apply to crossings and parallel runs.

## SECTION 462-450-205CA

**4.02** In Tables A and B the specified separations must be obtained for parallel runs.

**4.03** The specified separations must be obtained at crossings designated *No Alternative* in Tables A and B.

**4.04** Separations and protection requirements for wiring which is placed on outside walls of buildings and is to be extended to off-premises stations, outdoor stations, loud ringing bells, etc, are the same as those specified for drop and block wire and are shown in Table B.

**4.05** Separations of less than 6 feet between drop, block, and station wiring, or telephone ground wires and lightning wires or rods are permissible under the following conditions:

(a) Where telephone, power, and lightning rod ground connections are made to a common grounding medium.

(b) Where separate driven ground rods are used for telephone, power, and lightning rod installations, **and the ground rods are bonded together.**

**Note:** *In no case shall the separation be less than 4 inches.*

**4.06** Tables A and B list the minimum separations between telephone wiring and foreign conductors or metallic objects outside or inside buildings.

**4.07** Table A applies only to telephone wiring between the protector (fuseless or fused) and the telephone equipment and to telephone wiring requiring no protector.

**4.08** Table B applies only to telephone wiring (drop or block) attached to the building and feeding a protector (fuseless or fused).

**4.09** Table C lists the minimum separations that shall be obtained between drop wire in the span to a building and foreign conductors or metallic objects.

## 5. MECHANICAL PROTECTION

**5.01** Where it is not practicable to obtain recommended minimum separation at crossings other than those shown as *No Alternative* in Tables A and B, or where wire or cable runs are subject to mechanical damage, abrasion, or excessive heat, a protective covering is required as shown in Fig. 1. The protective covering should be used as follows:

- B Plastic Tube, P Wire Guard, or two layers of vinyl tape extending 2 inches beyond each side of object being crossed.
- P Wire Guard, B Plastic Tube, or two layers of vinyl tape shall be used in all cases where telephone wiring is subject to abrasion or mechanical damage. E Wire Guard (plastic tubing) may be used in place of vinyl tape or P Wire Guard on station wiring within buildings where improved appearance is desired. (See Fig. 2.)

**5.02** Where plastic-insulated station wire passes through wall or floor adjacent to wall or baseboard, protection with vinyl tape or E Wire Guard is not required unless wire is subject to mechanical damage or abrasion.

**5.03** Where station wiring passes over floor away from wall or baseboard, protect it from mechanical damage with overfloor ducts and associated fittings as covered in Section 461-350-100.

**5.04** Fig. 3 through 14 are typical examples of wiring that requires protection.



**Do not run wires or cables through removable gratings.**

**TABLE A — SEPARATION AND PHYSICAL PROTECTION FOR WIRING BETWEEN  
PROTECTOR AND TELEPHONE EQUIPMENT**

This table applies only to telephone wiring from fuseless or fused protector to telephone equipment and to telephone wiring requiring no protector. Minimum separations between telephone wiring outside or inside buildings, and type of plant involved, are as follows. Separations apply to crossings and to parallel runs.

TYPE OF PLANT INVOLVED		MINIMUM SEPARATIONS	PROTECTION REQUIRED IF MINIMUM SEPARATIONS CANNOT BE OBTAINED <sup>1</sup>
Electric Supply	<i>Bare light or power wire of any voltage</i>	5 ft <sup>2</sup>	No Alternative <sup>2</sup>
	Open wiring not over 300 volts	2 in.	See Note 3
	Wires in conduit, or in armored or nonmetallic sheath cable, or power ground wires	None	
Radio and Television	Antenna lead-in and ground wires	4 in.	See Note 3
Signal or Control Wires	Open wiring or wires in conduit or cable	None	
Communication Wires	Community television systems coaxial cables with shields at ground potential	None	
Telephone Drop or Block Wire	Using fused protectors	2 in.	See Note 3
	Using fuseless protector or where no protector required	None	
Telephone Ground Wire		None	
Sign	Neon signs and associated wiring from transformer	6 in. <sup>4</sup>	Lead cable with sheath grounded. Ground requirements same as for signaling ground.
Lightning System	Lightning rods and wires	6 ft	See Para. 4.05
Pipe	Steam or hot water or heating ducts	See Note 5	See Note 5
Stationary Grating, Metal Shutter Grillwork, etc.		P Wire Guard, or two layers of vinyl tape required in all cases to resist abrasion.	

**Note 1:** Applies only to crossings. For parallel runs the indicated minimum separations must be maintained.

**Note 2:** *Power is to be turned off if working above bare wire.* Ladders shall be placed to maintain a 5-foot minimum clearance.

**Note 3:** B Plastic tube; E or P Wire Guard; or two layers of vinyl tape extending 2 inches beyond each side of object being crossed.

**Note 4:** To prevent accidental breakage, avoid neon sign location if alternate run is possible.

**Note 5:** Excessive heat may damage plastic-insulated wires, therefore avoid heating ducts and other heat sources.



SECTION 462-450-205CA

TABLE B — WIRING BETWEEN BUILDING ATTACHMENT AND TELEPHONE PROTECTOR			
This table applies only to telephone wiring (drop or block) attached to buildings and feeding a fuseless or fused protector. Minimum separations between telephone wiring outside or inside buildings, and type of plant involved, are as follows. Separations apply to crossings and to parallel runs.			
TYPE OF PLANT INVOLVED		MINIMUM SEPARATIONS	PROTECTION REQUIRED IF MINIMUM SEPARATIONS CANNOT BE OBTAINED <sup>1</sup>
Electric Supply	<i>Bare light or power wire of any voltage</i>	5 ft <sup>2</sup>	No Alternative <sup>2</sup>
	Service drops or open wiring not over 750 volts	4 in.	P Wire Guard extending 2 inches beyond each side of object being crossed
	Wires in conduit, or in armoured or nonmetallic sheath cable, or power ground wires	2 in.	
Radio and Television	Antenna lead-in and ground wires	4 in.	
Signal Wire	Open wiring or wires in conduit or cable	2 in.	
Communication Wires	Foreign open wiring and wires in conduit or cable	2 in.	
	Between exposed and unexposed Telephone Company wires		
	Community television systems coaxial cables with shields at ground potential	None	
Metallic Object	Downspouts and gutters	2 in.	
	Stationary Gratings, etc.	P Wire Guard or two layers of vinyl tape required in all cases to resist abrasion	
Telephone Ground Wire		None	
Sign	Neon signs and associated wiring from transformer	6 in.	P Wire Guard, 12 inches long <sup>3</sup>
Lightning System	Lightning rods and wires	6 ft	See Para. 4.05
Telephone Ground Rods to Other Ground Rods		6 ft	No Alternative
<p><b>Note 1:</b> Applies only to crossings. For parallel runs the indicated minimum separations must be maintained.</p> <p><b>Note 2:</b> <i>Power is to be turned off if working above bare wire.</i> Ladders shall be placed to maintain a 5-foot minimum clearance.</p> <p><b>Note 3:</b> To prevent accidental breakage, avoid neon sign location if alternate run is possible.</p>			

TABLE C — DROP WIRE SPANS TO BUILDINGS			
Minimum separations between drop wire spans to buildings and type of plant involved, are as follows:			
TYPE OF PLANT INVOLVED		DROP WIRE SPAN TO BUILDING MINIMUM SEPARATION	
		CROSSING	PARALLEL
Electric Supply	Service drops or open wiring not over 750 volts	2 ft	1 ft
	Wires in conduit, or in armoured or nonmetallic sheath cable	4 in.	4 in.
Radio and Television	Antenna lead-in and ground wires	2 ft	1 ft
Signal Wires	Open wiring	2 ft	1 ft
	Wires in conduit or cable	4 in.	4 in.
Communication Wires	Foreign open wiring	2 ft	1 ft
	Foreign wires in conduit or cable	4 in.	4 in.
	Community television systems coaxial cables with shields at ground potential	4 in.	4 in.
Metallic Objects	Rain spouts, gutters, etc	4 in.	4 in.
Ground Wires	Ground wires (except radio, television, and lightning ground wires)	4 in.	4 in.
Lightning	Lightning wires and rods	6 ft	6 ft
Signs	Neon sign and associated wiring from transformer	1 ft	1 ft

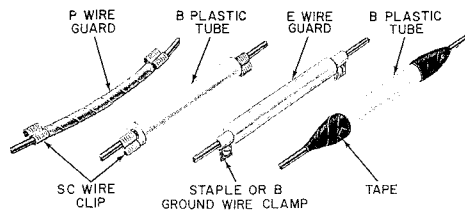


Fig. 1—Securing Wire Guards

SECTION 462-450-205CA

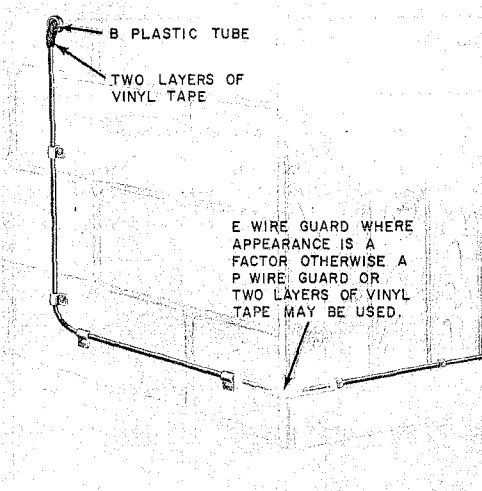
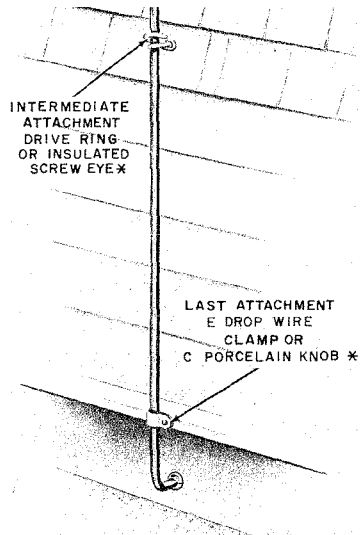


Fig. 2—Use of Vinyl Tape or E Wire Guard



\* USE INSULATED ATTACHMENTS WHERE FUSED PROTECTION IS REQUIRED.

Fig. 4—Crossing Wood or Stucco on Wood Building Projection

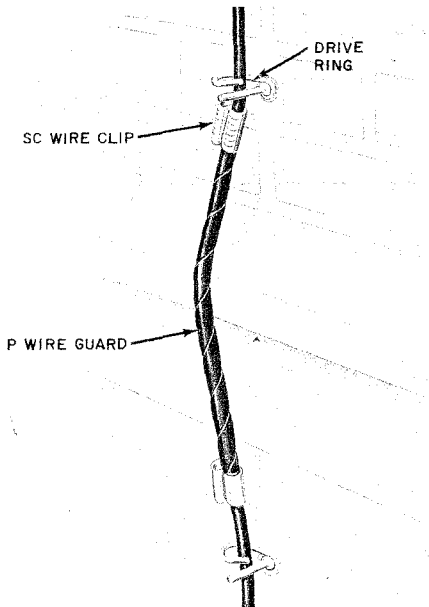


Fig. 3—Crossing Masonry Building Projection

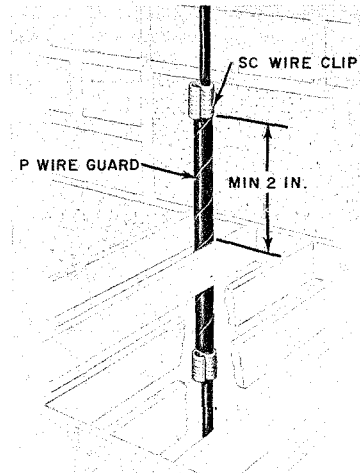


Fig. 5—Protecting Wire Run Through Stationary Metal Grating

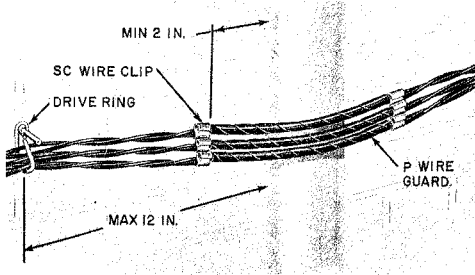


Fig. 6—Block Wires Crossing Over Pipe

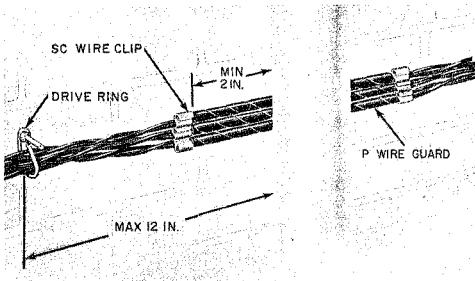
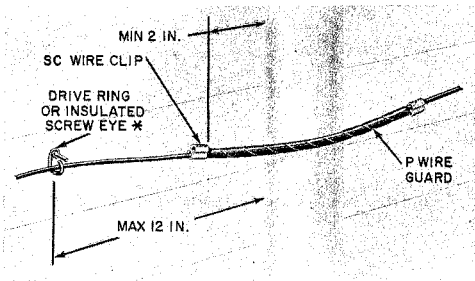


Fig. 7—Block Wires Crossing Behind Pipe



\*USE INSULATED ATTACHMENTS WHERE FUSED PROTECTION IS REQUIRED.

Fig. 8—Drop Wire Over Pipe

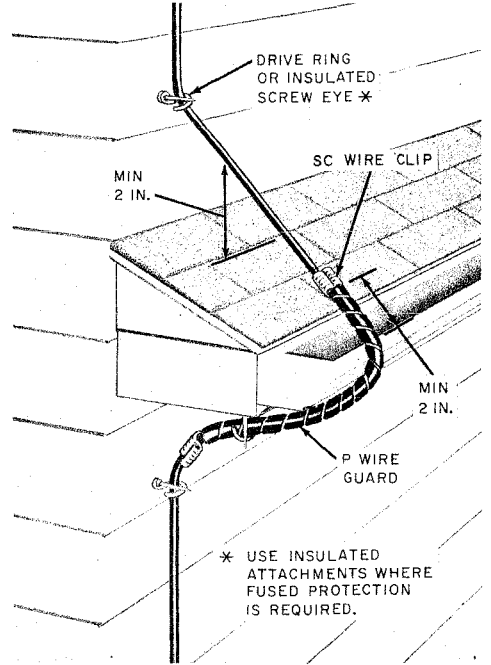


Fig. 9—Crossing Building Overhangs and Gutters

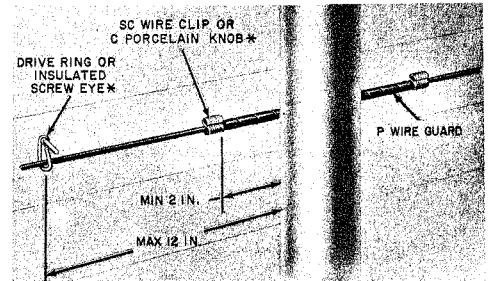


Fig. 10—Drop Wire Crossing Behind Pipe

SECTION 462-450-205CA

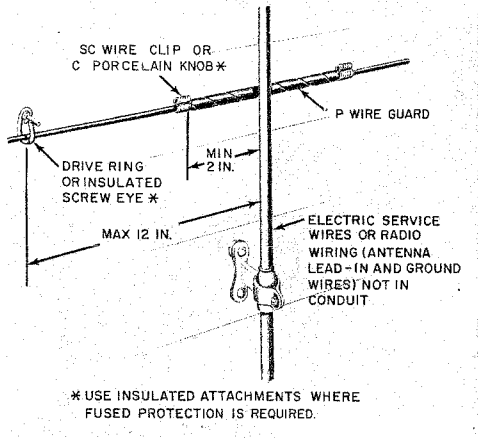


Fig. 11—Drop Wire Crossing Behind Foreign Wire

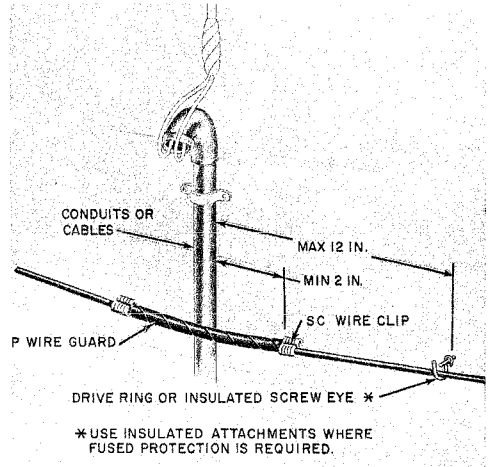


Fig. 13—Drop Wire Crossing Over Conduit

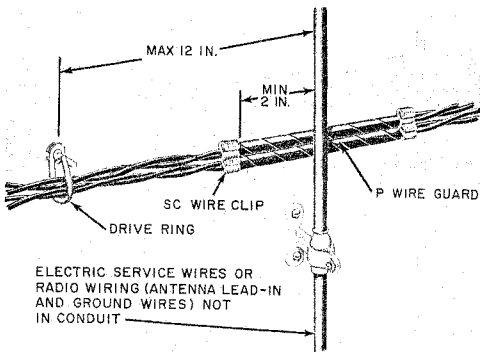


Fig. 12—Block Wire Crossing Behind Foreign Wire

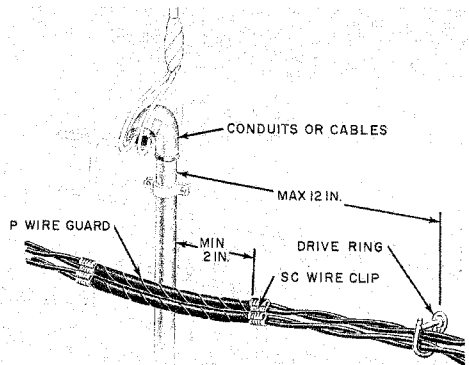


Fig. 14—Block Wire Crossing Over Conduit

## DROP AND BLOCK WIRING

### PLACING WIRE AND CABLE FOR AUTOTRAILERS

#### 1. GENERAL

**1.01** This section covers general information and procedures pertaining to the placing of drop and block wire, and station wire and cable for autotrailers.

**1.02** This section replaces 625-460-200CA, which is cancelled.

**1.03** Placing drop wire, station wire and cable, and station protectors on autotrailers should be on the same basis as installations for permanent buildings with the exceptions noted herein. Makeshift pole lines, insufficient clearances, etc, should definitely be avoided.

**1.04** Prior to proceeding with installation, all necessary arrangements with the customer and autotrailer park manager should be made. These arrangements may include facilities such as private poles, opening and closing trenches for buried underground wire, and permission to attach wire to the autotrailers. Where such arrangements have not been made or are unsatisfactory, refer the matter to the supervisor.

**HAZARD:-** Do not climb or place ladder against subscriber's owned 4 x 4 poles.

**1.05** Where attachments are made on jointly used poles and posts, the standard separations between power and telephone wires shall be provided as for permanent residences.



*Defects in electrical equipment or wiring in an autotrailer may energize the body and present an electrical hazard to persons in or near the autotrailer. If a hazardous condition is found to exist, workman shall proceed no further until the condition has been corrected and his supervisor informed of the condition. Workman should inform autotrailer occupant of any hazardous condition found.*

#### 2. TESTING AUTOTRAILER

**2.01** Before workman makes bodily contact with *any* metal portion of autotrailer, the following tests should be made:

- (1) Test metallic autotrailer body for possibility of being energized.
- (2) Test chassis of autotrailer body for possibility of being energized.

**2.02** Workman should use the best available ground (water pipe, ground rod, etc) for making test:

**2.03** To verify presence or absence of hazardous voltage on autotrailer body or chassis, use the Z voltage tester as described in Section 620-105-010. If it is necessary to cut through paint to insure good contact between autotrailer and Z voltage tester, select an inconspicuous location to avoid marring the appearance of the autotrailer. Use insulating gloves and avoid bodily contact with autotrailer during this operation.



*If Z voltage tester indicates that any part of the autotrailer is energized, do not proceed until condition is corrected and supervisor is informed. (See 1.05).*

#### 3. INSTALLING SERVICE DROPS

**3.01** The distribution plant serving a trailer camp may be any of the following types, depending on the number of lines required.

- Drop Wire—Multiple or Single
- Distribution Wire
- Aerial Cable

Service to individual trailer may be either an aerial drop wire or a buried wire. Typical service connections to trailers are shown in Fig. 1 and 2.

SECTION 462-460-200CA

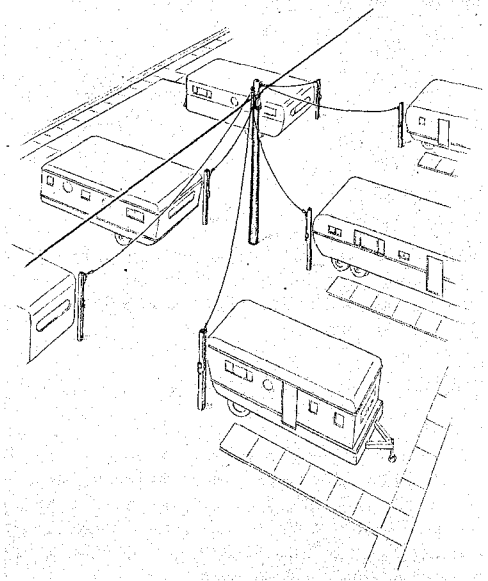
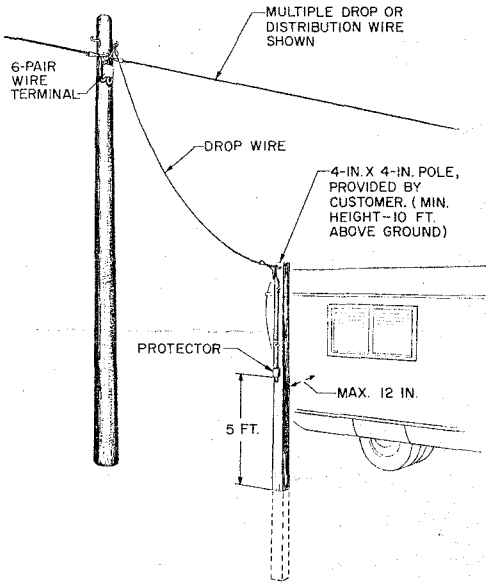


Fig. 1 - Typical Aerial Service Connections

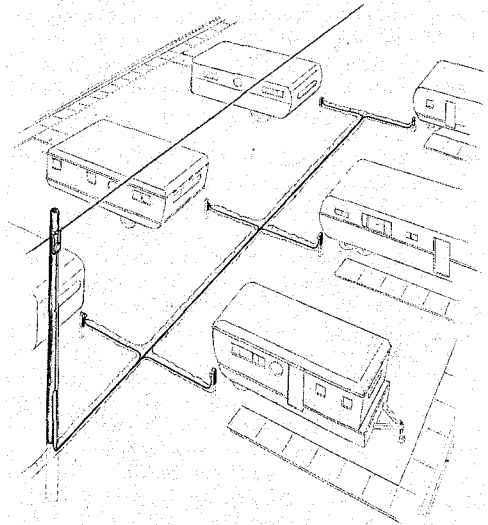
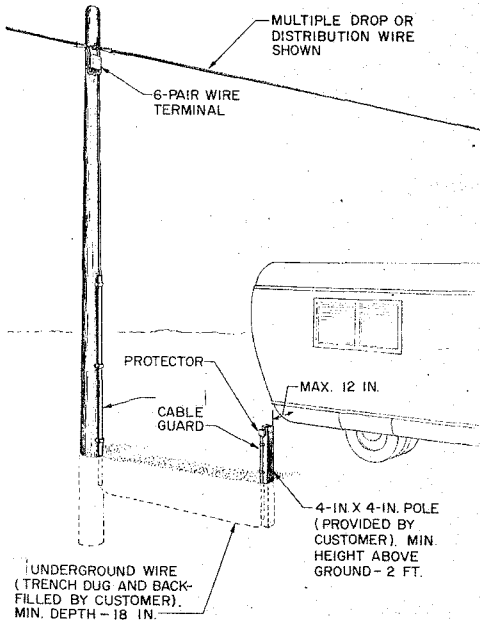


Fig. 2 - Typical Buried Service Connections

#### 4. INSTALLING STATION WIRE AND CABLE

4.01 Autotrailer installations generally vary, depending on the type of facilities provided by the customer. Typical wiring arrangements are shown in Fig. 3 and 4.

4.02 The protector should be located as near as possible to the autotrailer on a private post or mounted on the outside surface of autotrailer. When mounting protector on outside surface of autotrailer, use 79-type or other suitable backboard. This backboard may also be used for the drop or block wire attachment.

#### Grounding

4.03 Refer to protector and grounding practices for proper grounding medium and wiring of protector.

#### Bonding Autotrailer

4.04 The protector ground should be bonded to the autotrailer body or chassis by No. 10 ground wire. The ground wire bonding the autotrailer should be installed to give the best possible mechanical protection, such as that shown in Fig. 3 and 4.

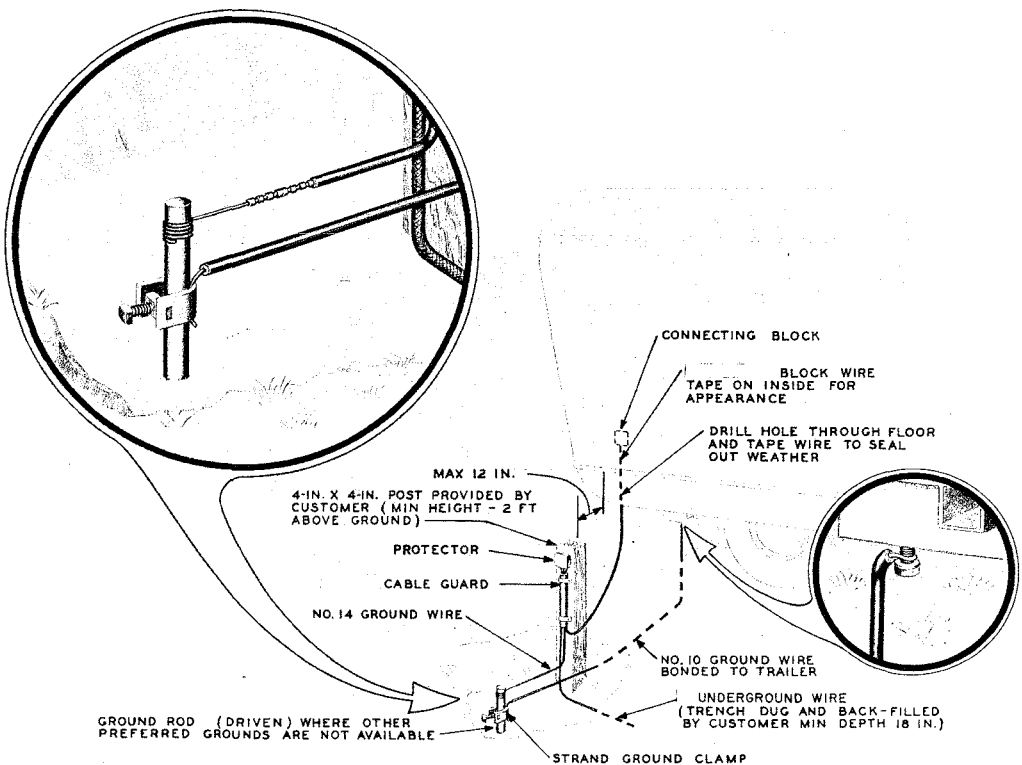


Fig. 3 — Buried Wire Distribution

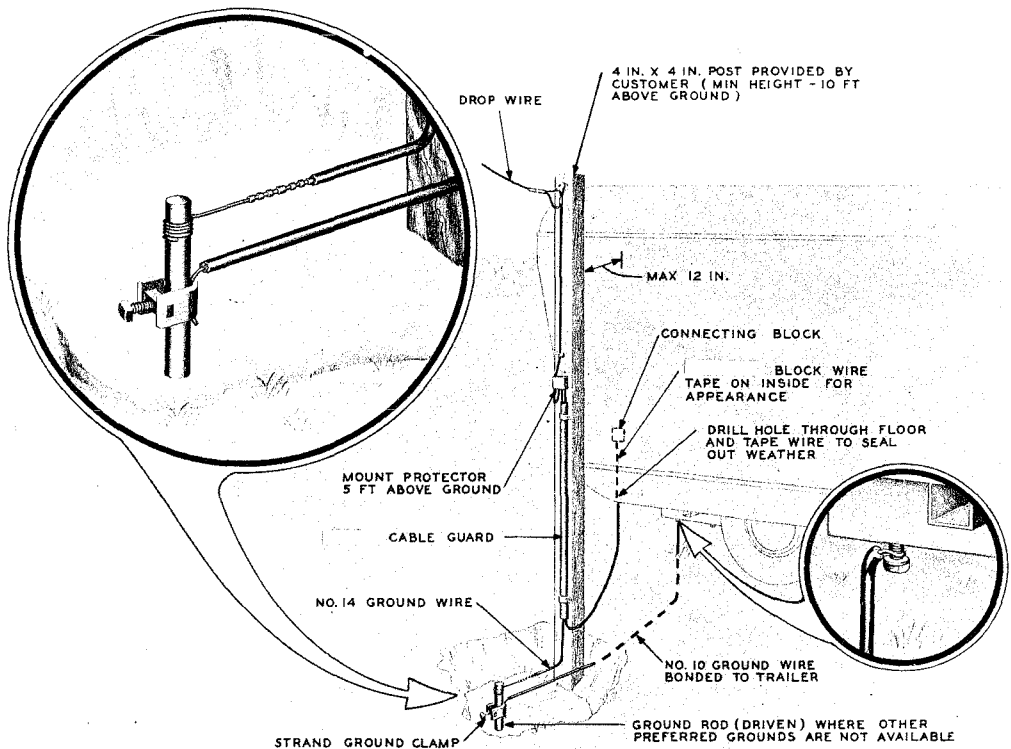


**Wiring**

**4.05** The inside wiring and cabling of auto-trailers should be on the same basis as that for permanent structures. In some auto-trailers, short lengths of conduit for telephone wiring are provided between the bottom of the auto-trailer and outlet locations. Where such facilities are not provided, entrance holes generally should be drilled in the floor of the auto-trailer, the wire pulled through, taped to seal out weather, and

terminated on a connecting block on the inside wall of the auto-trailer. On auto-trailers that move often and require telephone service, it may be desirable to place permanent wiring inside of auto-trailer to a protector mounted on the outside.

**4.06** Use wood guard or conduit from post to auto-trailer to protect drop or block wire from damage when the post cannot be placed 12 inches or less from the auto-trailer.



**Fig. 4 - Drop Wire Distribution**

**DROP AND BLOCK WIRING**  
**MULTIPLE DROP WIRE**  
**STRINGING SAGS**

**1. GENERAL**

- 1.01 This section covers stringing sags for multiple drop wire.
- 1.02 This section is reissued to revise Table A and B and update information.

1.03 Table A gives normal stringing sags to which multiple drop wire should be strung in all cases where ground clearances can be met.

**TABLE A**  
**NORMAL STRINGING SAGS FOR MULTIPLE**  
**DROP WIRE**

Span Length	Stringing			Final Unloaded Sag Following Storm Loading		Sag Increase from Stringing to Final Condition
	Sag		Tension	ft.	in.	
ft.	ft.	in.	lb.	ft.	in.	in.
100	1	9	110	2	0	3
125	2	10	110	3	4	6
150	4	0	110	4	6	6

**TABLE B**  
**MINIMUM STRINGING SAGS FOR MULTIPLE**  
**DROP WIRE**

Span Length	Stringing			Final Unloaded Sag Following Storm Loading		Sag Increase from Stringing to Final Condition	
	Sag		Tension	ft.	in.	ft.	in.
ft.	ft.	in.	lb.	ft.	in.	ft.	in.
100	1	4	150	1	11	7	
125	2	1	150	2	9	8	
150	3	0	150	3	8	8	

**1.04** Table B gives minimum stringing sags to which multiple drop wire may be strung to obtain necessary ground clearance not possible with the normal stringing sags of Table A.

**1.05** The high tensions corresponding to both normal minimum stringing sags require the use of the multiple drop wire puller when placing the wire in spans. This puller also provides a means for snubbing the wire preparatory to placing the drop wire clamp.

**1.06** Tables A and B indicate the approximate final unloaded sag which multiple drop wire will develop after being subjected to ice and wind storms. Allow for these sag increases at the time of wire placing in order to avoid possible resagging of the wire subsequent to storm loading.

**1.07** Multiple drop wire should preferably be distributed from a pole but it may be distributed from a span clamp provided the cable suspension strand is not pulled out of line noticeably.

**2. NORMAL STRINGING SAGS FOR MULTIPLE DROP WIRE**

**2.01** String multiple drop wire to the sags in Table A on pole-to-pole and pole-to-house spans except in those cases where adequate ground clearance can only be obtained with the minimum sags of Table B.

**3. MINIMUM STRINGING SAGS FOR MULTIPLE DROP WIRES**

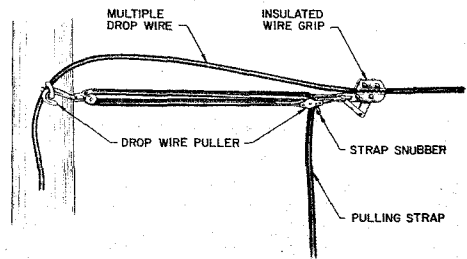
**3.01** Use the minimum sags of Table B in cases where these reduced sags provide the only means of obtaining ground clearances under the wire in spans.

**4. STRINGING MULTIPLE DROP WIRE IN SPANS**

**4.01** Pay out multiple wire in pole-to-pole and pole-to-house spans in the manner prescribed for drop wire.

**4.02** Pull multiple wire to required sag at poles using the multiple drop wire puller for tensioning and snubbing of the wire. Proceed as follows:

- (1) Suspend the hook of the wire puller on the drive hook placed in the pole. Pull the wire hand-tight and then reach out and place the wire grip of the puller on the multiple wire at arm's length.
- (2) Pull the wire up to the required sag and hold by tripping the strap snubber on the puller.



**Fig. 1 — Tensioning Multiple Drop Wire**

(3) Place the D drop wire clamp loosely on the slack section of wire between the wire grip and the pole. Take up on the slack wire and tighten the clamp with its tail wire about 1/2 inch short of the wire hook.

(4) Pull up on the wire by means of the puller to permit hanging the clamp on the drive hook.

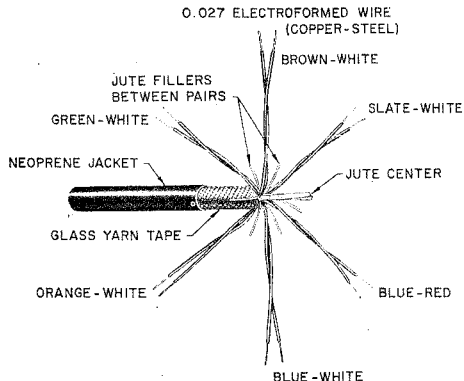
(5) Remove the multiple drop wire puller.

**4.03** The sag given to multiple drop wire may be estimated by sighting between wire supports.

**DROP AND BLOCK WIRING**  
**MULTIPLE DROP WIRE**  
**DESCRIPTION**

**1. GENERAL**

- 1.01 This information was formerly covered in Section 625-500-100CA which is cancelled.
- 1.02 Multiple drop wire is used for making multiple drop connections where fuseless type or no station protection is required.
- 1.03 Information for B multiple drop wire and C multiple drop wire of earlier design is included.



**Fig. 1 — C Multiple Drop Wire (Present Design)**

**2. DESCRIPTION OF MULTIPLE DROP WIRE**

2.01 Multiple drop wire consists of six twisted pairs of conductors. Each conductor is rubber insulated and neoprene jacketed. The insulation of one conductor of each pair is of a distinctively different color to provide ring and tip identification, as well as pair identification. The six pairs are cabled together, and wrapped with glass yarn tape into a tight core. The assembly is encased in a black neoprene jacket.

2.02 The following table indicates the colour identification of the Z multiple drop wire.

Pair No.	Tip	Ring
1	White	Blue
2	White	Orange
3	White	Green
4	White	Brown
5	White	Slate
6	Red	Blue

2.03 Fig. 1 illustrates the details of Z multiple drop wire.

2.04 Multiple drop wire is a self-supporting type of wire which can be supported by means of D drop wire clamps in spans up to 150 feet in length.

The approximate breaking strength of Z multiple wire is 1700 pounds. The wire weighs approximately 16 pounds per hundred feet. Multiple drop wire is designed to be handled in the same manner as single-pair drop wire.

**3. ASSOCIATED MATERIALS AND APPARATUS**

3.01 Materials and apparatus required in connection with the installation of multiple drop wire are listed below:

Material or Apparatus	Use
D Drop Wire Clamp	For supporting the wire at span attachments.
Multiple Drop Wire Puller	For pulling the wire to proper tension and snubbing it.
116C Protector	A 6-pair fuseless station protector for inside or outside mounting.
117A Protector	A 6-pair fuseless protector for inside use.

SECTION 462-500-100CA

Material or Apparatus	Use
104-Type Wire Terminal	A 6-pair wire terminal similar to the 116A or 116C protector but without protectors.
B Drive Hook	Pole attachment.
Drop Wire Hook	First building attachment.
Drop Wire Hook Strap	To secure a drop wire hook on first building attachment.
No. 18 RH Galv. Wood Screw 2 inch	For fastening drop wire hook to studding of frame building.
5/16 inch by 1-3/4 inch Hammer Drive Anchor	For fastening drop wire hook on masonry walls.
No. 20 Cable Clamp	For second and last building attachments. May also be used as intermediate attachments.
5/8 inch Drive Ring	For intermediate building attachments.
No. 10 Ground Wire	For grounding the 116A or 116C protector to water pipe.

**4. CUTTING MULTIPLE DROP WIRE**

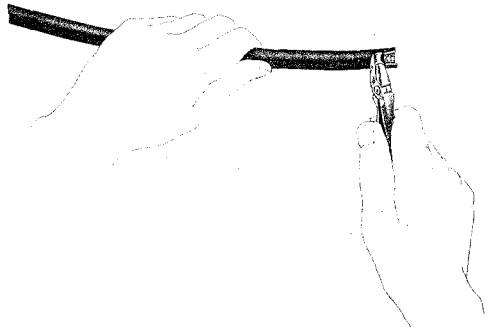
**4.01** Use 6-inch SW diagonal pliers for cutting across multiple drop wire. It will be necessary to make several cuts with the pliers to complete the operation. Make an initial cut in the wire with the points of the pliers and bend the wire back at the cut so as to expose the inside conductors. Then proceed to cut a few conductors at a time until the cut is completed.

**4.02** Eight-inch side cutting pliers can also be used for cutting multiple wire. It may require several presses of the pliers to cut through the wire.

**5. REMOVING OUTER JACKET ON MULTIPLE DROP WIRE**

**5.01** In terminating multiple drop wire at terminals and protectors it is necessary to

remove the outer jacket in order that the pairs can be fanned out. Strip the jacket as follows:

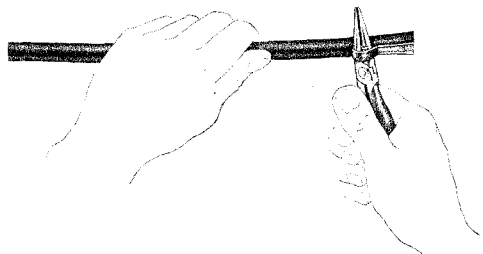


**Fig. 2 — Rolling the Jacket with Diagonal Pliers**

(1) Make two longitudinal cuts opposite each other on the multiple drop wire by means of the large groove of the C braid stripper.

(2) Grip the jacket at the wire end with diagonal pliers and roll the jacket back on itself as illustrated in Fig. 2.

(3) Release the rolled back portion of jacket and grip it again with long nose pliers. Again roll the jacket back on itself until it pulls free of the glass yarn tape, then pull off the jacket with a strong steady pull over the required distance from the wire end. See Fig. 3.



**Fig. 3 — Rolling the Jacket Back on Itself with Long-Nose Pliers**

(4) Repeat operations of Steps 2 and 3 for the remaining segment of jacket.

(5) Unwrap the glass yarn tape around the wire core and fan out the pairs for conductor skinning and terminating. Cut off excess yarn tape and filler.

## DROP AND BLOCK WIRING MULTIPLE DROP WIRE PLACING

CONTENTS	PAGE
1. GENERAL . . . . .	259
2. USE . . . . .	259
3. PLANNING MULTIPLE DROP WIRE RUNS . . . . .	259
4. MULTIPLE DROP WIRE RUNS ON BUILDINGS . . . . .	260
5. MULTIPLE DROP WIRE RUNS ALONG A LEAD . . . . .	262
6. DISTRIBUTING MULTIPLE DROP WIRE FROM TERMINAL POLES . . . . .	262
7. PLACING D DROP WIRE CLAMPS ON MULTIPLE DROP WIRE . . . . .	262
8. COLOUR CODING . . . . .	263
9. TERMINATING MULTIPLE DROP WIRE IN CABLE TERMINALS . . . . .	263
10. TERMINATING MULTIPLE DROP WIRE IN 116C PROTECTORS . . . . .	264
11. TERMINATING MULTIPLE DROP WIRE IN 104B WIRE TERMINALS . . . . .	264

### 1. GENERAL

1.01 This section covers methods for placing Multiple Drop Wire in spans and on buildings. It is reissued to update information and to incorporate Addendum.

### 2. USE

2.01 In general, Multiple Drop Wire should be used in preference to establishing a group

of drop wire runs to serve apartment buildings, multiple dwellings, small P.B.X.s, etc., and only under exceptional circumstances should it be used in lieu of cable as distribution facility, especially when intermediate terminals are required for distribution purposes. When used as a distribution facility the non-working or disconnected pairs shall be grounded at the cable junction terminal using a 5A or 6A Ground Strip as described in Section 638-310-105.

2.02 Multiple drop wire must **NOT** be used to serve subscribers' premises from open line wire or multiple line wire.

### 3. PLANNING MULTIPLE DROP WIRE RUNS

3.01 In planning Multiple Drop Wire Runs on building walls observe the rules outlined in Section 462-350-213CA. Particular attention should be given to the following suggestions.

(a) Select a location for the first attachment which will keep the drop wire clear of trees. In some cases an adjacent building may be used for the first attachment as a means of avoiding trees.

(b) Locate ring runs with a view to permanency and accessibility. Avoid runs requiring the use of long ladders.

(c) Make all runs horizontal or vertical insofar as practical. Horizontal runs should be placed out of reach of the public particularly children.

(d) Locate wire runs with a minimum of obstructions.

(e) Where necessary to cross or parallel electric wiring, rain spouts or other obstructions, the minimum separations covered in Section 620-220-011CA for drop wiring should be observed.

**3.02** Multiple Drop Wire is supplied on large reels. It will be necessary to make a preliminary survey of a proposed installation to determine the length of wire required so as to avoid excess wire loss. Cut required length of wire from reel in garage or storeroom and if not over 250 feet, it can be coiled on the drop wire reel. If length is over 250 feet, coil the wire in a hand coil of convenient size. Should a number of installations be at close locations, it may be desirable to take the reel of wire to the job and distribute as required. A Roller Platform may be helpful in such cases.

**3.03** Clearances over public and private swimming pools are not covered by Safety Codes or other practices. However, for reasons of safety, sanitation, and appearance, aerial drop wire crossing over swimming pools should be avoided.

**4. MULTIPLE DROP WIRE RUNS ON BUILDINGS**

**4.01 First Building Attachment:** Use a Drop Wire Hook installed on a Drop Wire Hook Strap as the first building attachment for multiple drop wire spans to buildings. The strap is provided with 5/16 inch No. 18 x 1/2 inch R.H. Galvanized Machine Screw for attaching the hook to the strap. *Only one multiple drop wire span shall be attached to a Drop Wire Hook.*

**4.02** Install Drop Wire Hook Strap to the various types of building surfaces as follows:

Brick, Masonry, Substantial Brick Veneer	} 2—5/16-inch x 1-3/4-inch Hammer Drive Anchors
Wood Thin Composition Siding	} 2—2-inch No. 18 R.H. Galv. Wood Screws placed in studding. Use 1-1/2-inch screws on solid timber.
Thin Wall or Unsubstantial Brick Veneer, Heavy Composition Siding or Stucco on Wood	} 2—No. 18 R.H. Galv. Wood Screws. Screws to pene- trate wood studding at least 1 inch.
Hollow Tile	} 2—5/16-inch x 5-inch R.H. Toggle Bolts. Bolts to be located in separate tiles where practical.

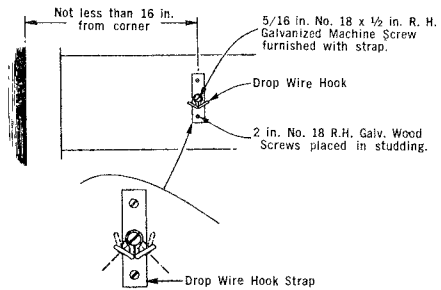


Illustration 1

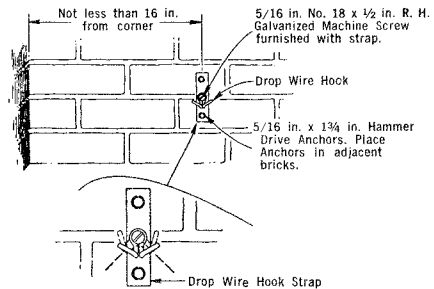


Illustration 1A

**4.03 Second Building Attachment:** Clamp the wire to the wall close to the Drop Wire Hook attachment with a No. 20 Cable Clamp. Attach clamp to walls as follows:

Masonry	} 1/4-inch x 1-inch Hammer Drive Anchor.
Wood Thin Composition Siding	} 1-1/2-inch No. 14 R. H. Galv. Wood Screw. Use 1-inch Screw on solid timber.
Stucco on Wood Heavy Composition Siding	} 2-inch No. 14 R. H. Galv. Wood Screw.

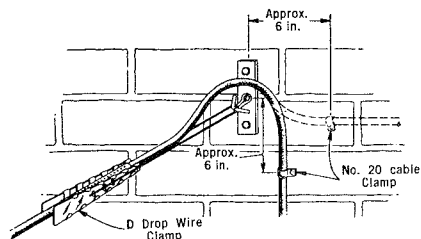


Illustration 2

**4.04 Intermediate Building Attachments:**

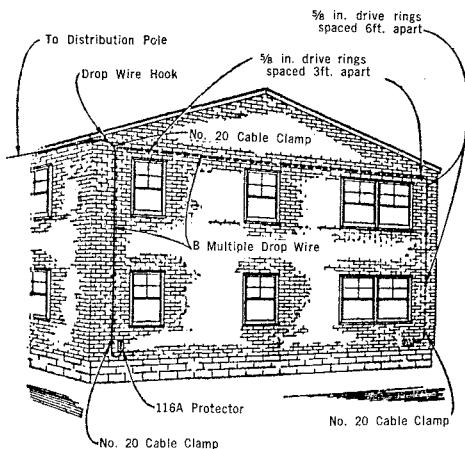
Where a high level of appearance is not of importance, support wire with  $\frac{5}{8}$ -inch Drive or Bridle Rings spaced approximately 3 feet apart in horizontal runs and approximately 6 feet apart in the vertical runs. Use larger size rings if more than one multiple drop wire is in building run or where individual wires parallel multiple drop wire run. It will be necessary to spread the opening in the rings slightly in order to insert the multiple drop wire. Where a high level of appearance is of importance, attach wire runs along walls with No. 20 Cable Clamps spaced at reduced intervals when necessary.

**4.05 Last Building Attachment:**

Place a No. 20 Cable Clamp on the multiple drop wire approximately 6 inches from point of entrance to protector, wire terminal or building after pulling the wire taut in the building run. Attach clamp to wall as indicated in Para. 4.03.

**4.06 Building Entrance:** Provide a  $\frac{3}{4}$ -inch hole when entering building with multiple drop wire. Slope entrance hole upward from outside, wherever practical. Tape wire and wedge tightly into entrance hole to avoid seepage of water between wire and building wall. Where it is not practical to slope entrance hole upward from outside, provide a 3-inch drip loop at entrance and tape and wedge wire tightly into entrance hole.

**4.07** Typical wire run on outside building wall is illustrated below:



**Illustration 3**

**Note:** Use No. 20 Cable Clamps in place of rings where a high level of appearance is of importance.

**4.08** Fasten multiple drop wire to building walls with a No. 20 Cable Clamp at the beginning and end of the run in order to maintain dress of wire in ring run.

**4.09** Where wire is run in auxiliary cable rings (strand supported block cable run) use No. 10 Lashed Cable Supports and  $\frac{1}{4}$ -inch Cable Spacers in place of cable clamps to attach the multiple drop wire to strand at beginning and end of strand supported run. Place supports and spacers as outlined in Section 627-300-216.

**4.10 Guards:** To provide Mechanical Protection of Wires on Buildings or in the span, place the required length or lengths of P or C Wire Guards. The C Wire Guard will slide freely over the multiple drop wire and should be used where protection in a span is required. The C Wire Guard shall be held in place in the manner described in Section 624-030-105.

**4.11 Terminations:** The multiple drop wire may be terminated in a 6-pair wire terminal or a 6-pair protector as specified below.

(a) **No Station Protection Required:** Terminate wire on the outside wall or inside the building on a 104B Wire Terminal. Where appearance and wire would not be objectionable a 30A Connecting Block could be used for terminations inside the building.

(b) **Fuseless Station Protection Required:** Terminate wire on the inside of a building on a 117A Protector unless appearance of protector, etc., would be objectionable; in which case terminate the wire on the outside of a building in a 116C Protector. **TERMINATE ALL PAIRS (WORKING AND NON-WORKING) ON PROTECTORS.**

**Note:** In addition to 116C or 117A Protectors, 60 type (sneak current) fuses are required on P.B.X. trunks, tie lines and leased or special service lines, etc., as covered in the P.B.X. Installation and Maintenance Practices.



**5. MULTIPLE DROP WIRE RUNS ALONG A LEAD**

**5.01 Attachments:** Spans of multiple drop wire are supported at all dead ends and intermediate poles by the D Drop Wire Clamp. The clamp is supported on poles by a Drive Hook. *Only one multiple drop wire (not span) shall be attached to a drive hook.* Drive Hooks shall be located and installed on poles in the same manner as prescribed for individual drop wires in pole-to-pole and pole-to-building runs.

**5.02** Where the placing of a multiple drop wire span interferes with climbing space on a jointly used pole, provide climbing space by distributing existing individual drop wires from span clamps or guard arms.

**5.03** At intermediate poles, provide approximately 3 inches slack between clamps as for individual drop wires.

**5.04 Guying:** Unless poor soil conditions exist, there is no requirement for guying corners or deadends of a single multiple drop wire installation. Under adverse soil conditions individual judgment should be used to determine whether the corner or deadened pole should be ground braced, set deeper or guyed.

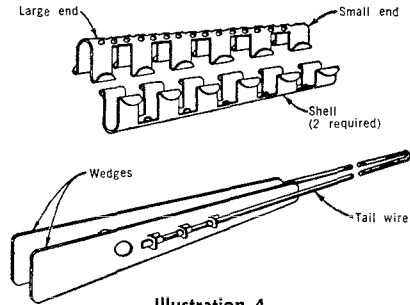
**6. DISTRIBUTING MULTIPLE DROP WIRE FROM TERMINAL POLES**

**6.01** Distribute multiple wire in the manner described for individual drop wires.

**7. PLACING D DROP WIRE CLAMPS ON MULTIPLE DROP WIRE**

**7.01** The D Clamp is designed primarily for use on Multiple Drop Wire. It consists of two identical semicircular shells and two flat wedges

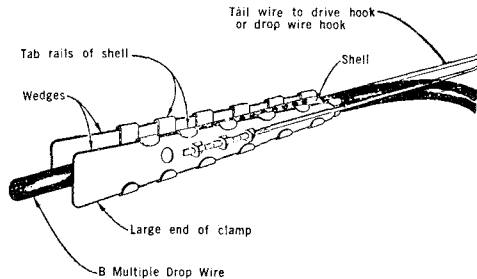
held together by a tail wire. The clamp is illustrated below:



**Illustration 4**

**7.02** Install the clamp on the wire in the following manner:

- (1) Interlock the two shells on the wire with the large ends toward the span.
- (2) Press the shells together and slide the wedges into the tab rails on the sides of the shells. Tap the wedges with pliers to seat them firmly.
- (3) Place the tail wire over the drive hook or drop wire hook.
- (4) Complete assembly of clamp on wires is illustrated below:



**Illustration 5**

**7.03** Since the D Drop Wire Clamp is constructed from Stainless Steel, and consequently has an unlimited service life, care should be exercised in any removal operation involving this clamp to ensure its recovery for further use.

## 8. COLOUR CODING

**8.01** The colour coding of the conductors of Multiple Drop Wire should facilitate the identification and termination of the individual pairs to a considerable degree.

**8.02** The following patterns for Multiple Drop Wire shall be used when determining the order of terminations in all terminals or protectors.

Pair No.	Z Multiple Drop Wire	
	Tip	Ring
1	White	Blue
2	White	Orange
3	White	Green
4	White	Brown
5	White	Slate
6	Red	Blue

## 9. TERMINATING MULTIPLE DROP WIRE IN CABLE TERMINALS

**9.01** When pairs in a multiple drop wire run are NOT terminated at the cable or other distribution facility terminal, each pair not cut into service shall be tagged with Drop Wire Tags at the time the wire is placed.

**9.02** Wire Pairs shall be numbered or tagged in accordance with the colour code outlined in Para. 8.02.

**9.03** Locate tag on the non-terminated pairs between the jacket and the first drive or terminated ring.

**9.04** At Pole and Wall Mounted Terminals remove the outer jacket and glass yarn tape back to approximately two inches before the drive or bridle ring at which the routing of the standard wire run at terminal divides to provide wire slack for reterminations. Fan out the pairs, run them through the rings and terminate them in the terminal as prescribed for Block Wire.

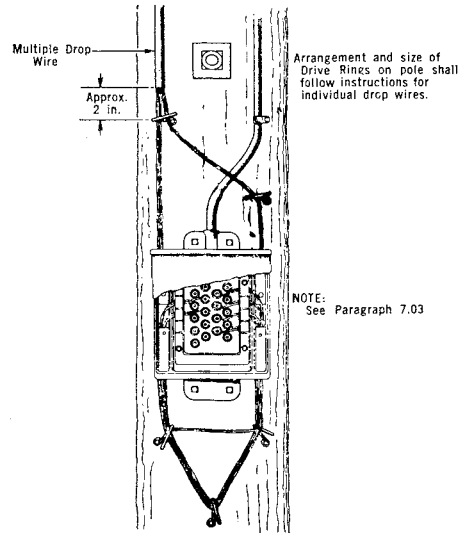


Illustration 6

**9.05** When a sufficient length of a pair in multiple drop wire is not available for retermination by shortening the run in the drive or terminal rings, splice out the pair with Block Wire or reterminate the multiple drop wire in a 6-pair wire terminal and bridle between the wire and cable terminals.

**9.06** Where a high rate of distributing cable pair changes is anticipated, such as in an apartment building, terminate the multiple drop wire in a 6-pair wire terminal and bridle between the Wire and Cable Terminals.

**Note:** The multiple drop wire should normally be terminated directly in the cable terminal for economic reasons.

**9.07** At Sheath Mounted Terminals remove outer jacket and glass yarn tape approximately one inch beyond terminal wiring ring nearest the pole. Fan out the pairs, run them through the rings and terminate them in the terminal as described for paired wire.

**9.08** The requirements for protection that apply to individual drop wires also shall be observed in multiple drop wire runs. Where cable or wire requires 6 mil gap protection use the 116D Protector. When a multiple drop wire run extends

**SECTION 462-500-200CA**

into an exposed area the unexposed status of the feeder or distribution cable can be maintained, provided the cable is effectively grounded and a 116C Protector (3 mil gap) is placed at the junction of the multiple drop wire and unexposed cable.

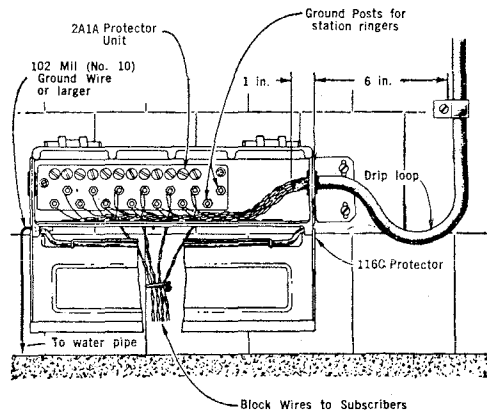
**10. TERMINATING MULTIPLE DROP WIRE IN 116C PROTECTOR**

**10.01** The 116C Protector is equipped with a housing smaller than the 10-pair N-Type Terminal. The new housing is provided with suitable bosses and holes which eliminate the use of the 45A bracket and permit mounting directly on either a flat surface or a pole. Install the 116C Protector on wood by means of two—2 inch No. 14 R.H. Galv. Wood Screws. On masonry the 116C Protector may be attached with two No. 12 Plastic Screw Anchor and two — 2 inch No. 14 R.H. Galv. Wood Screws.

**10.02** A drip loop shall be formed in the multiple drop wire where it enters the protector housing if the protector is mounted outdoors. When mounted vertically, the multiple drop wire shall enter at the bottom of the protector. When mounted in a horizontal position wire entrance grommets shall be at the bottom.

**10.03** The protector shall be grounded with a 102 mil (No. 10), or larger, Ground Wire connected to a metallic public water system ground and where no water system exists, in accordance with the provisions covered in appropriate sections on grounding. The ground wire shall be connected to the protector housing with the ground clamp provided on the outside of the housing.

**10.04** Insert the multiple drop wire into either end of the protector as desired. It will greatly facilitate pair terminations if the end of the multiple drop wire is stripped of its outer jacket before inserting the wire into the protector housing.



**Illustration 7**

**10.05** Dress the multiple drop wires so that they will be close to the back of the box. The individual pairs shall be terminated, in accordance with the colour code outlined in Para. 8.02, under the bottom nut on each binding post. The individual drop or block wire connections enter through the series of grommets as for N Type Terminals and are terminated between the top and bottom nuts of the binding posts.

**11. TERMINATING MULTIPLE DROP WIRE IN 104B WIRE TERMINAL**

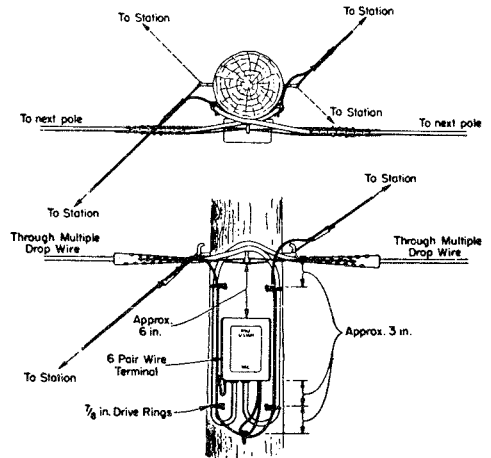
**11.01** When no protection is required, multiple drop wire may be terminated in a 104B Wire Terminal. The 104B Wire Terminal is equipped with a housing similar to the 116C protector and is mounted in the same manner as described in Para. 10.01 for the 116C Protector.

**11.02** Insert the multiple wire in one of the outer holes of the wire terminal so that about one inch of the jacket extends inside the housing. It will greatly facilitate conductor termination if the end of the multiple drop wire is stripped of its outer jacket before inserting the wire into the terminal housing.

11.03 Terminate the conductors under the bottom nut on each binding post, following the colour sequence described in Para. 8.02. Terminate the station drop wires between the top and bottom nuts on the binding post.

11.04 This terminal can also be used at the end of a drop wire run as a distribution point for stations not requiring protection and when specified on the work plans it shall be installed at intermediate poles as shown below.

*Note:* At the intermediate terminals the through multiple drop wire run shall be cut and the individual pairs from both directions shall be twisted together and terminated between the washers under the bottom nuts. All pairs from both directions shall be terminated in order to effectively protect the complete drop wire run. In twisting the individual pairs together prior to terminating, the colour coded pattern outlined in Para. 8.02 shall be followed.





## DROP AND BLOCK WIRING X MULTIPLE DROP WIRE

CONTENTS	PAGE
1. GENERAL . . . . .	267
2. DESCRIPTION . . . . .	267
3. ASSOCIATED MATERIALS AND APPARATUS . . . . .	268
4. STRINGING SAGS . . . . .	268
5. REMOVAL OF P.V.C. JACKET . . . . .	269
6. PLANNING X MULTIPLE DROP WIRE RUNS . . . . .	270
7. PLACING: BUILDING ATTACHMENTS . . . . .	271
8. PLACING: POLE AND SPAN ATTACHMENTS . . . . .	273
9. PROTECTION . . . . .	274
10. TERMINATING . . . . .	274
11. SPLICING . . . . .	275

### 1. GENERAL

1.01 This Section provides information on X Multiple Drop Wire and is reissued to revise Table 1.

1.02 X Multiple Drop Wire is designed for making multiple drop connections to: Multiple family dwellings, small PBXs, and multiple pay stations.

### 2. DESCRIPTION

2.01 X Multiple Drop Wire consists of six pairs of 22 gauge polyethylene insulated conductors which are spiralled and laid parallel to a 109H steel support wire. Both the conductors and support wire are jacketed with a black P.V.C. Compound. These two jackets are joined by a thin web so that the two units may be readily separated without damage to the jacket of either unit. A sitting cord is provided to facilitate the removal of the jacket covering the conductors.

- NOTES:  
 1. P.V.C. JACKET  
 2. RIP CORD  
 3. 109H STEEL SUPPORT WIRE  
 4. COLOUR CODED PAIRS

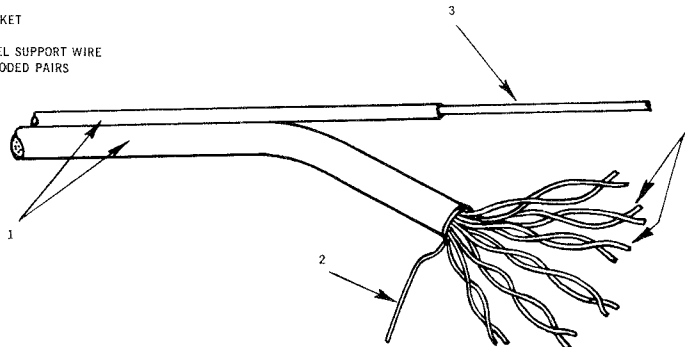


Fig. 1 — X Multiple Drop Wire

**SECTION 462-500-900CA**

**2.02** The following table indicates the colour-coding of the X Multiple Drop Wire pairs.

**X MULTIPLE DROP WIRE**

<u>Pair No.</u>	<u>Tip</u>	<u>Ring</u>
1	White	Blue
2	White	Orange
3	White	Green
4	White	Brown
5	White	Slate
6	Red	Blue

**2.03** The X Multiple Drop Wire is a self-supporting type of wire which can be supported by means of 109 Preformed Wire Grips in a span up to 150 feet in length. The minimum breaking strength of the X Multiple Drop Wire is 1200 lbs. The wire weighs 77 lbs. per 1000 feet.

**3. ASSOCIATED MATERIALS AND APPARATUS**

**3.01** Materials and apparatus required in connection with the installation of Multiple Drop Wire as covered in this Section, are listed below:

<u>Material or Apparatus</u>	<u>Use</u>
Grip, Wire Preformed 109	For supporting the wire at deadends and span attachments.
Block Wire Light	For pulling the wire to proper tension and snubbing it.
116C Protector	A 6-pair fuseless station protector for outside mounting.
117B Protector	A 6-pair fuseless station protector for inside mounting.
104B Wire Terminal	A 6-pair wire terminal similar to the 116C Protector but without protectors.
B Drive Hook	Pole attachment
S Porcelain Knob; Angle Screw; House or Corner Bracket; Drop Wire Hook	First building attachment (See Section 462-350-213 for method of attachment).
No. 12 Cable Clamp	For second and last building attachments. May also be used as intermediate attachments.
5/8" Drive Ring	For intermediate building attachments.
No. 10 Ground Wire	For grounding the Protector.

**4. STRINGING SAGS**

**4.01** Table 1 gives the minimum sags to which X Multiple Drop may be strung to obtain the necessary ground clearance.

**TABLE 1**

**Minimum Stringing Sags for X Multiple Drop Wire Stringing (60°F.)**

<u>Span Length</u>	<u>Sag</u>	<u>Tension</u>
100 ft.	1' 7"	60 lbs.
125 ft.	2' 6"	"
150 ft.	3' 7"	"

**4.02** Pay out multiple drop wire in pole-to-pole, and pole-to-house spans, in the manner prescribed for drop wire.

**4.03** Pull multiple drop wire to required sag at the pole using the Light Wire Block equipped with a Buffalo Grip and Swivel Hook. Proceed as follows:

- (a) Suspend the hook of the Light Wire Block on the drive hook placed in the pole. Pull the wire hand tight, and secure temporarily.
- (b) Remove the jacket from the support wire where the Buffalo Grip is to be placed.
- (c) After placing the Buffalo Grip, pull the wire up to the required sag, and hold by tripping the Light Wire Block.
- (d) Position the preformed wire grip on the support wire (after jacket has been removed) so that it may be placed on the drive hook.

(e) Remove the light wire blocks, and apply one half-looped layer of vinyl tape over exposed support wire and conductors.

## 5. REMOVAL OF P.V.C. JACKET

**5.01** The P.V.C. Jacket may be removed from the support wire by using the Inside Wiring Cable Stripper. The cable stripper will remove a strip of the jacket enabling the support wire to be pulled out of its covering.

**5.02** A slitting cord is provided to slit the P.V.C. Jacket so that it may be removed from the conductors.

**5.03** To separate the support wire from the conductor at terminating locations or for making building runs, slit the web for approximately 2 inches using diagonal pliers. To complete the separation, pull the support wire and conductors in a slow, steady manner in opposite directions; at right angles to the major cross-sectional axis of the wire (See Figure 4).

The slow, steady pull is especially important, to avoid cracking the jacket, when the temperatures are below zero.

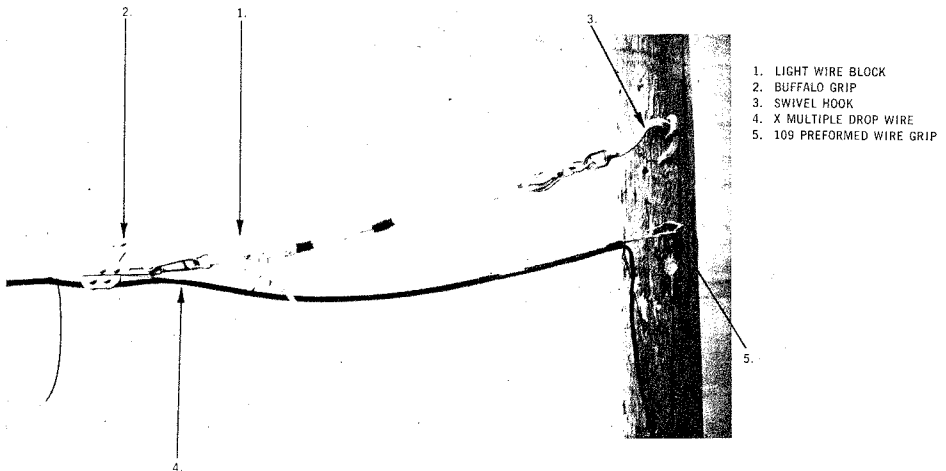


Fig. 2



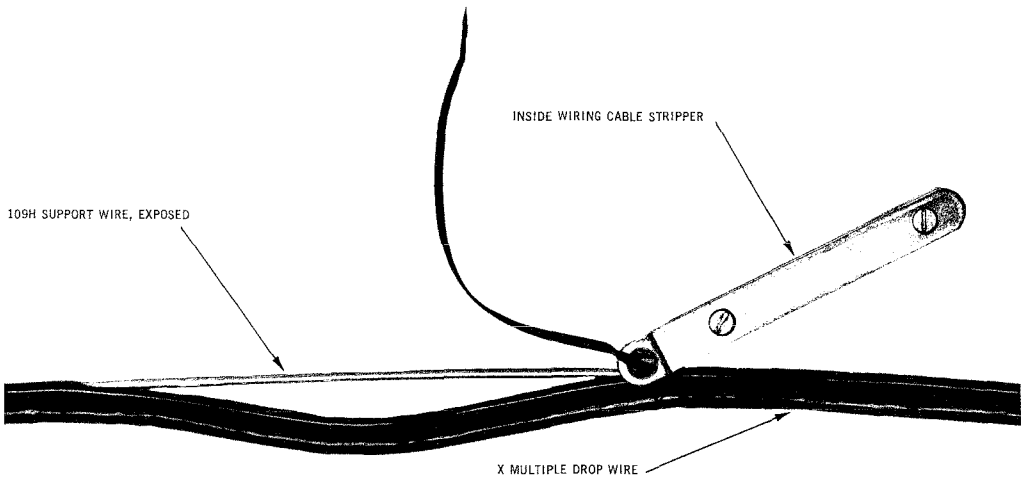


Fig. 3

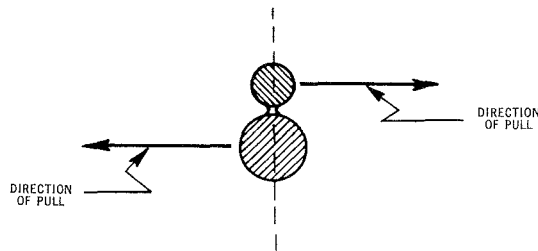


Fig. 4

**6. PLANNING X MULTIPLE DROP WIRE RUNS**

**6.01** X MULTIPLE DROP WIRE MUST NOT BE USED TO SERVE SUBSCRIBERS PREMISES FROM OPEN LINE WIRE OR MULTIPLE LINE WIRE.

**6.02** In planning Multiple Drop Wire Runs on building walls observe the rules outlined in Section 462-350-213. Particular attention should be given to the following suggestions:

(a) Select a location for the first attachment which will keep the drop wire clear of

trees. In some cases an adjacent building may be used for the first attachment as a means of avoiding trees.

(b) Locate ring runs with a view to permanency and accessibility. Avoid runs requiring the use of long ladders.

(c) Make all runs horizontal or vertical insofar as practical. Horizontal runs should be placed out of reach of the public, particularly children.

- (d) Locate wire runs with a minimum of obstructions.
- (e) Where necessary to cross or parallel electric wiring, rain spouts or other obstructions, the minimum separations covered in Section 620-220-011 for drop wiring should be observed.

**6.03** Clearances over public and private swimming pools are not covered by Safety Codes or other practices. However, for reasons of safety, sanitation, and appearance, aerial drop wire crossing over swimming pools should be avoided.

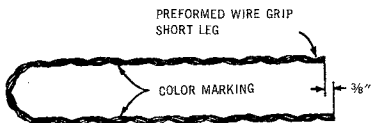
**7. PLACING: BUILDING ATTACHMENTS**

**7.01** Place a building attachment, Drop Wire Hook, Angle Screw, House Bracket or Corner Bracket equipped with an S Porcelain Knob, (Section 462-350-213) — in a location that will keep the multiple drop clear of trees or other obstructions.

**7.02** Separate the support wire from the conductors.

**7.03** Use a 109 Preformed Wire Grip to terminate the support wire on the building attachment. The wire grip is composed of 3 preformed steel wires, assembled into a hairpin shape. The inner surface of the bore is coated with grit to increase the holding power. The legs are unequal in length to facilitate unwrapping. The crossover and starting point is identified by a yellow marking.

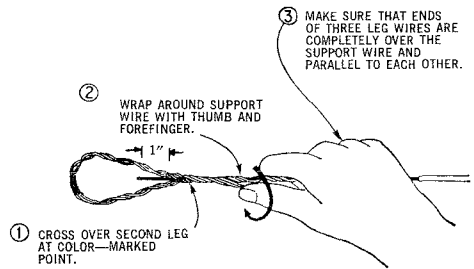
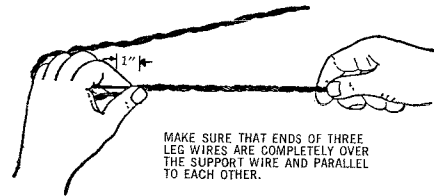
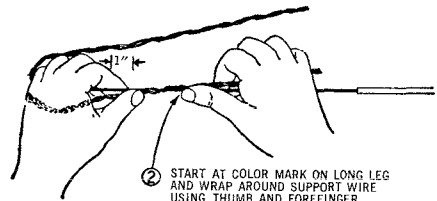
**7.04** Place the 109 Preformed Wire Grip on the support wire as follows:



**109 Preformed Wire Grip**

- (a) Cut the support wire at the point of building attachment.
- (b) Remove 12 inches of jacket from the support wire and apply a 109 Preformed Wire Grip as shown in following illustrations.

**Note:** For the sake of clarity, the conductors have been omitted.



(c) Wrap 5 turns of Vinyl tape around the joined support wire and conductors at a point 2 inches beyond the end of the wire grip. The last turn should be laid on free from all tension so that the end of the tape will not start to curl back.

(d) Place the Preformed Wire Grip over the building attachment.

(e) Run the jacketed conductors to the building and secure them with a No. 12 cable clamp as shown in following:

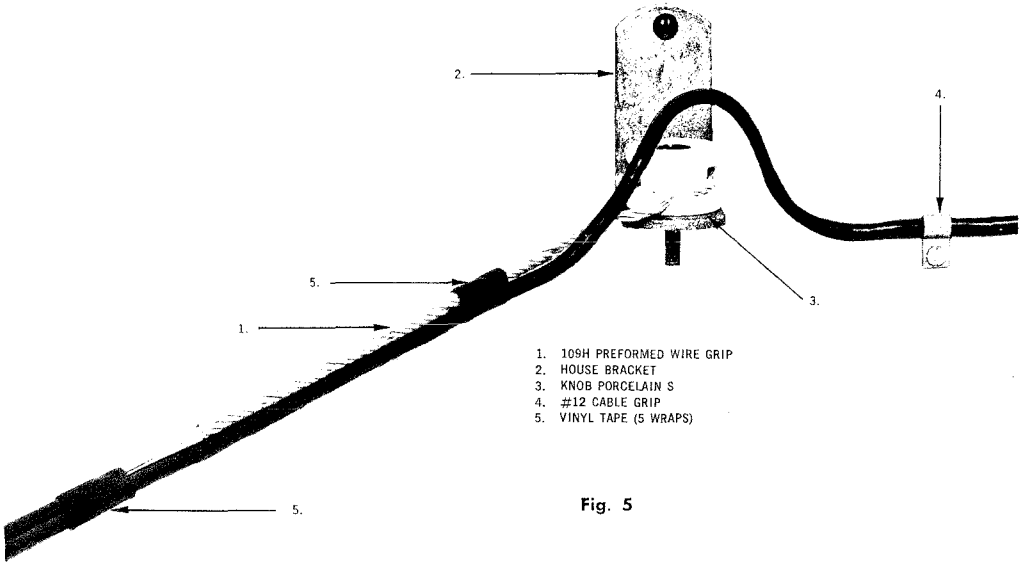


Fig. 5

**7.05 Intermediate Building Attachments:** Support wire with  $\frac{5}{8}$ " Drive Rings spaced approximately 3 feet apart in the vertical runs, and approximately 6 feet apart in the horizontal runs. Use larger size rings if more than one multiple drop wire is in building run or where individual drop wire parallel multiple drop wire run. Where a high level of appearance is of importance, attach wire runs along walls with No. 12 Cable Clamps spaced at reduced intervals when necessary.

**7.06 Last Building Attachment:** Place a No. 12 Cable Clamp on the multiple drop wire approximately 6 inches from point of entrance to protector, wire terminal or building after pulling the wire taut in the building run.

**7.07 Building Entrance:** Provide a  $\frac{3}{8}$ -inch hole when entering building with multiple drop wire. Slope entrance hole upward from outside, wherever practical. Tape wire and wedge tightly into entrance hold to avoid seepage of water between wire and building wall. Where it is not practical to slope entrance hole upward from outside, provide a 3-inch drip loop at entrance and tape and wedge wire tightly into entrance hole.

**7.08 Typical wire run on outside building wall** is illustrated below:

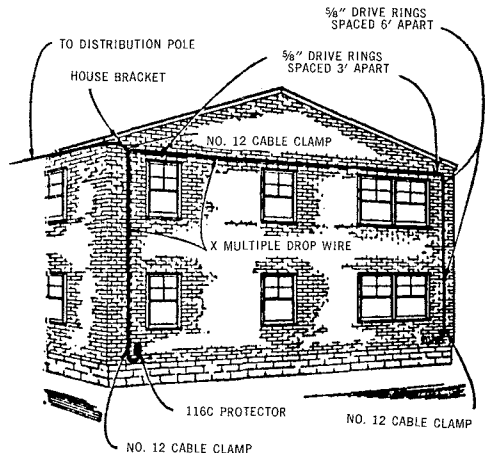


Fig. 6

**Note:** Use No. 12 Cable Clamps in place of rings where a high level of appearance is of importance.

**7.09** Fasten multiple drop wire to building walls with a No. 12 Cable Clamp at the beginning and end of the run in order to maintain dress of wire in ring run.

## 8. PLACING: POLE AND SPAN ATTACHMENTS

**8.01** Spans of X Multiple Drop Wire are supported at all dead ends and intermediate poles by the 109 Preformed Wire Grip. The grip is supported on poles by a Drive Hook and only one multiple drop wire shall be attached to a drive hook. Drive hooks shall be located and installed on poles in the same manner as prescribed for individual drop wires.

**8.02** Where the placing of a multiple drop wire span interferes with climbing space on a jointly used pole, provide climbing space by distributing the drop wires from span clamps.

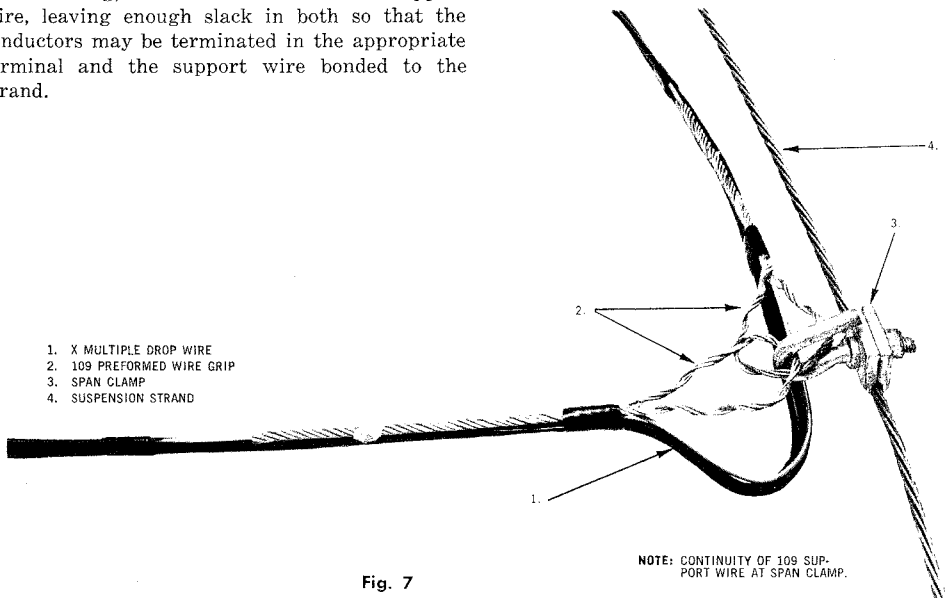
**8.03** Pull the multiple drop wire up to its proper sag, cut the conductors and support wire, leaving enough slack in both so that the conductors may be terminated in the appropriate terminal and the support wire bonded to the strand.

**8.04** Separate the jacketed support wire from the jacketed conductors to a point approximately 15 inches out from the pole attachment. Without cutting the support wire, remove the insulation and place a preformed wire grip. Attach the wire grip to the drive hook.

**8.05** Wrap 5 turns of Vinyl tape around the joined support wire and conductors at a point two inches beyond the end of the wire grip. The last turn should be laid on free from all tension so that the end of the tape will not start to curl back.

**8.06** Distribute the multiple drop wire in the manner described for individual drop wires. Bond the support wire to the suspension strand using a lashing wire clamp.

**8.07** Where a span clamp is required, pull the multiple drop wire to the proper sag. Remove the jacket from the support wire for approximately 15 inches on either side of the point of attachment using the inside wiring cable stripper. Without cutting the support wire attach two preformed grips and hooks onto the clamp.



1. X MULTIPLE DROP WIRE
2. 109 PREFORMED WIRE GRIP
3. SPAN CLAMP
4. SUSPENSION STRAND

**Fig. 7**

**NOTE:** CONTINUITY OF 109 SUPPORT WIRE AT SPAN CLAMP.

## SECTION 462-500-900CA

**8.08 Guards:** To provide mechanical protection of wires on buildings or in the span, place the required lengths of P and B Wire Guards. The B Wire Guard will slide freely over the multiple drop wire and should be used where protection in a span is required. The B Wire Guard shall be held in place on X Multiple Drop Wire by taping each end of the guard to the wire, with one inch vinyl tape.

### 9. PROTECTION

**9.01** The requirements for protection that apply to individual drop wires shall also be observed for X Multiple Drop Wire runs.

**9.02** Where the cable requires 6 mil gap protection use the 116D Protector.

**9.03** When a multiple drop wire extends into an exposed area the unexposed status of the feeder or distribution cable can be maintained provided the cable is effectively grounded and a 116C Protector (3 mil gap) is placed at the junction of the multiple drop wire and the unexposed cable. (See Section 638-200-200).

### 10. TERMINATING

**10.01** X Multiple drop wire may be terminated at a building in a 6 pair wire terminal or in a 6 pair protector as follows:

(a) **No Station Protection Required:** Terminate wire on the outside wall or inside the building in a 104B Wire Terminal. Where appearance and wire would not be objectionable a 66Q3A50 Connecting Block may be used for terminations inside the building.

(b) **Station Protection Required:** Terminate wire on the inside of a building in a 117B Protector unless appearance of protector and wire would be objectionable; in which case terminate the wire on the outside of a building in a 116C Protector. *Terminate all pairs (working and non-working).*

**Note:** In addition to 116C or 117B Protectors, 60 type (sneak current) fuses are required on PBX trunks, tie lines and leased or special service lines, etc., as covered in the PBX Installation and Maintenance Practices.

**10.02** When Wiring at a 116 Protector or 104 Wire Terminal proceed as follows:

(a) Where the protector or terminal is mounted horizontally insert the multiple drop wire into either end, leaving a 3 inch drip loop. (See Fig. 8).

(b) When the protector or terminal is mounted vertically insert the multiple drop wire through the bottom.

(c) Before placing the drop into the protector or terminal, remove the jacket from the conductors so that there will be 1 inch of jacket remaining on the conductors *inside* the housing. Use the Inside Wiring Cable Stripper to remove the jacket, taking care to avoid nicking the conductors.

(d) Dress the conductors of the X Multiple Drop Wire so that they will be close to the back of the housing. The individual pairs shall be terminated, (in accordance with the colour code outlined in Para. 2.02) under the bottom nut on each binding post.

**10.03** Terminating at Cable Terminal.

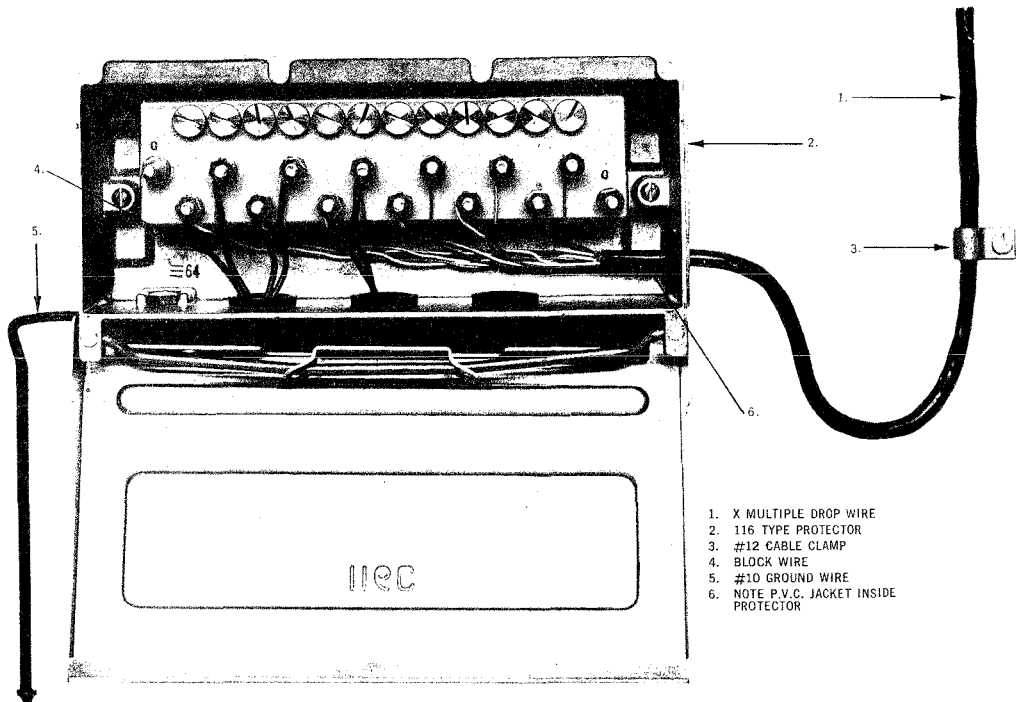
(a) Run the jacketed conductors through the drive rings in the usual manner.

(b) Before placing the drop into the terminal, remove the jacket from the conductors so that there will be 1 inch of jacket remaining on the conductors *inside* the housing. Use the Inside Wiring Cable Stripper to remove the jacket, taking care to avoid nicking the conductors.

(c) Run the conductors along the back of the housing underneath any existing drops and against the terminal block.

(d) Run each pair of conductors through the appropriate hole in the fanning strip (if there is one) and terminate on the assigned binding posts by placing the conductor under the bottom nut on each binding post.

**10.04** When a sufficient length of a pair in multiple drop wire is not available for retermination by shortening the run in the drive or terminal rings, the pair may be extended by using B Wire Connectors and a short length of X Multiple Drop Wire of the same colour code.



1. X MULTIPLE DROP WIRE
2. 116 TYPE PROTECTOR
3. #12 CABLE CLAMP
4. BLOCK WIRE
5. #10 GROUND WIRE
6. NOTE P.V.C. JACKET INSIDE PROTECTOR

Fig. 8

10.05 Where a high rate of distributing cable pair changes is anticipated, such as in an apartment building, terminate the multiple drop wire in a 6 pair wire terminal and bridle between the wire and cable terminal.

### 11. SPlicing

11.01 Generally, because X Multiple Drop Wire installations are relatively short, it will be more economical to replace the section rather than make the splice, however, when splicing is necessary the procedure is as follows:

- (a) Separate the jacket and support wire for a distance of 8 inches.
- (b) Wrap 5 tight turns of F Vinyl tape around both the support wire and jacket at the end of the separation.
- (c) Cut 2 inches off the end of the support wire. Remove sufficient covering from the end to allow placing an S-109H splice sleeve.

(d) Join the support wire using the S-109H splice sleeve pressed with the 31 Type Nicopress. Apply one-half lapped layer of F Vinyl tape over the sleeve, extending the tape 1 inch over the wire cover on each side.

(e) Remove 4 inches of the wire jacket. Care should be taken to avoid separating the tip and ring conductors.

(f) Join the conductors using NEB-Wire Connectors folding half the conductors to the left and half to the right. (See Fig 9).

(g) Complete the splice by placing 2 half-lapped layers of  $\frac{3}{4}$  inch DR tape over the connectors, extending the tape 1 inch over the jacket. Cover the DR tape with one-half lapped layer of F Vinyl tape.

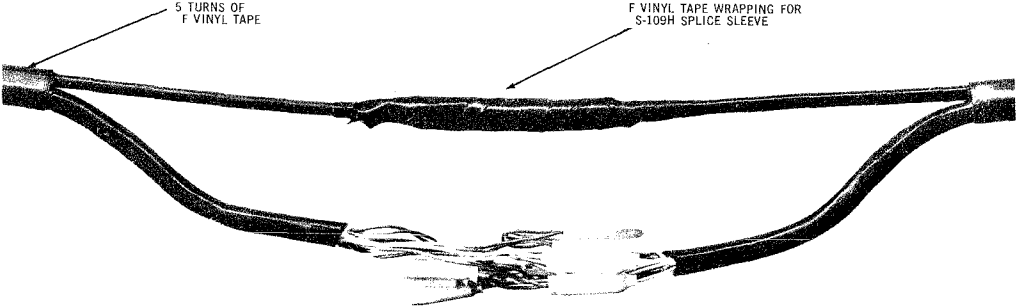


Fig. 9 – Spliced X Multiple Drop Wire

## DROP AND BLOCK WIRING

### LOWERING AND REPLACING DROP WIRE

### VOLTAGES LESS THAN 300 INVOLVED

#### 1. GENERAL

**1.01** This section covers the methods of lowering a drop wire, raising a lowered drop wire, and replacing a drop wire by pulling the new wire into the span as the old wire is pulled out of the span.

**1.02** This information was formerly covered in Section 625-800-311CA (G32.415.1) which is canceled.

**1.03** The procedures outlined herein apply specifically to the conditions usually encountered where the drop wire does not cross over trolley or trolley-bus contact wires or over power wires or power cables operating at 300 volts or more. The basic principles presented in this section should also be observed in those cases where conditions necessitate a departure from the usual procedures.

**1.04** The methods outlined herein are such that the drop wire is lowered, raised, or replaced by means of a handline while the employee remains on the ground where he can observe traffic, control the wire to prevent its striking persons or damaging property, and remove the wire from a street or highway quickly. An exception is made in certain cases where a wire, which does not cross a street or highway, may be dropped from a pole. The methods are intended also to avoid the possibility of accidents caused by releasing wire under tension from a building or strand attachment while working from a ladder or as the result of vehicles striking the wire as it is being lowered to the ground.

**1.05** Refer to Section 462-800-312CA for the methods of lowering or replacing a drop wire which crosses over trolley or trolley-bus contact wires or over power wires or power cables

operating at 300 volts or more. The methods of placing drop wires are covered in Sections 462-400-205CA and 462-400-206CA.

#### 2. PRECAUTIONS

**2.01** Obtain assistance before lowering a drop wire, raising a lowered drop wire, or replacing a drop wire over streets, highways, or elsewhere if traffic, tree, or other conditions are such that one man cannot do the work safely.

**2.02** Insulating gloves shall be worn by all employees when performing all operations in which the handline or the drop wire may come in contact with power wires or power cables.

**2.03** The handline used for lowering, raising, or replacing a drop wire under the conditions outlined in this section shall be free from metallic strands and shall preferably be dry. However, if weather conditions are such that it is impracticable to keep the handline dry, a wet handline may be used for lowering, raising, or replacing a drop wire over secondary electric service wires operating at less than 300 volts.

**2.04** In general, one 50-foot and one 100-foot 3/8-inch handline will be needed for the operations outlined in this section and Section 462-800-312CA. The handlines should be served at the ends to prevent unraveling.

**2.05** When it is necessary to carry a handline up a pole or ladder, double the end of the handline back on itself for a distance of approximately one foot and place this loop under the right or left side or back of the body belt or in such other position that the handline will be released readily if it is placed under tension while the employee is climbing the pole or ladder.



## SECTION 462-800-311CA

**2.06** Never release the drop wire supports from a wire span while working inside the angle formed by the wire.

**2.07** Avoid working from a ladder placed against a building with the side rails crossing a wire run or in any other position where movement of the wire, due to loosening of the attachments, would cause an accident.

**2.08** When a drop wire attached to a span clamp is to be lowered or replaced, place the foot of the extension ladder on the field side of the suspension strand and not in the street or highway. If there is no street or highway adjacent to the span clamp, place the ladder preferably against the opposite side of the strand from the drop wire run to the building.

**2.09** If conditions are such that the handline, or the drop wire to which it is attached, may become disengaged from a drive hook or crossarm or may slide along the strand or guard arm while doing the work outlined in this section, the handline or drop wire shall be enclosed with a temporary guide loop. This loop shall consist of a short length of wire or houseline placed over the handline or drop wire with the ends of the guide securely tied as follows:

- Drive Hook: Tie one end to the vertical portion of the drive hook and lash the other end to the pole.
- Crossarm: Tie the ends to adjacent pins or insulators.
- Guard Arm: Tie the ends to the guard arm on each side of the handline or drop wire.
- Strand: Tie the ends to the strand or the strand and lashed cable on each side of the handline or drop wire, or place the handline or drop wire through the hook of a span clamp.

### **3. LOWERING WIRE WHICH CROSSES A STREET OR HIGHWAY – WIRE ATTACHED TO POLE**

*Caution: The lowering of a taut drop wire span requires that special precautions be taken to ensure that the wire is lowered*

*safely. These special precautions are covered in Part 6 of this section.*

#### **Handline Lowering Method**

**3.01** Lower the drop wire from its position on the pole (drive hook, guard arm, or cross-arm) in accordance with the following sequence of operations.

- (1) Lash a handline securely to the base of the pole at a point on the handline which will leave a sufficient length on the ground so that this end will be accessible from the ground until the wire has been lowered to the street.
- (2) Place the other end of the handline over the strand, guard arm, drive hook, or crossarm so that this end is toward the building and reaches the ground. If practicable, the handline may be formed into a coil at one end and thrown over the strand. If the drop wire passes through a tree in the immediate vicinity of the pole attachment, place the handline so that it follows the route of the wire through the tree. A wire raising tool may be used to facilitate this operation. After the handline has been placed, tie it to the base of the pole to avoid interference with pedestrians or vehicles.

*Caution: The handline shall not overhang the street unless it is properly guarded. If practicable, park the telephone company vehicle so that it will shield the handline.*

- (3) Disconnect the drop wire from the terminal and remove the free end from the wiring rings on the pole.
- (4) Place a temporary drop wire clamp on the wire to be lowered, about one foot out in the span. Seat the clamp firmly on the wire.
- (5) Tie a loop of the handline to the tail of the temporary drop wire clamp so that the lashed end of the handline is sufficiently taut to remove tension from the original drop wire clamp.
- (6) Remove the original drop wire clamp from the wire span, thus leaving the wire supported by the temporary drop wire clamp and the lashed handline.

(7) Return to the ground. Untie the handline from the base of the pole and, when no vehicles or pedestrians are approaching, lower the drop wire to the ground by pulling that portion of the handline toward the building. The portion of the handline on the opposite side of the strand should pass through the employee's hand as shown in Fig. 1 in order that he may be able to pull the handline in either direction to work the drop wire among the branches of a tree or to raise the wire quickly if necessary.

(8) After the wire has been lowered to the street or highway, remove the temporary drop wire clamp from the wire, tie the handline to the base of the pole, and remove the wire from the street or highway.

#### 4. DROPPING WIRE WHICH DOES NOT CROSS A STREET OR HIGHWAY – WIRE ATTACHED TO POLE

*Caution: The lowering of a taut drop wire span requires that special precautions be taken to ensure that the wire is lowered safely. These special precautions are covered in Part 6 of this section.*

4.01 A wire span may be dropped from a pole provided conditions are such that: (a) the wire span does not cross a street or highway or over power wires or power cables, (b) a taut wire span is not involved, (c) the wire will not be struck by a passing vehicle, and (d) the wire will not fall on pedestrians or cause damage to property as a result of being dropped to the ground. If any of these conditions are present, the span shall be lowered by the handline method as covered in Part 3.

#### 5. LOWERING WIRE ATTACHED TO A SPAN CLAMP

*Caution: The lowering of a taut drop wire span requires that special precautions be taken to ensure that the wire is lowered safely. These special precautions are covered in Part 6 of this section.*

5.01 The lowering method covered in this part applies to all drop wire spans attached to span clamps.

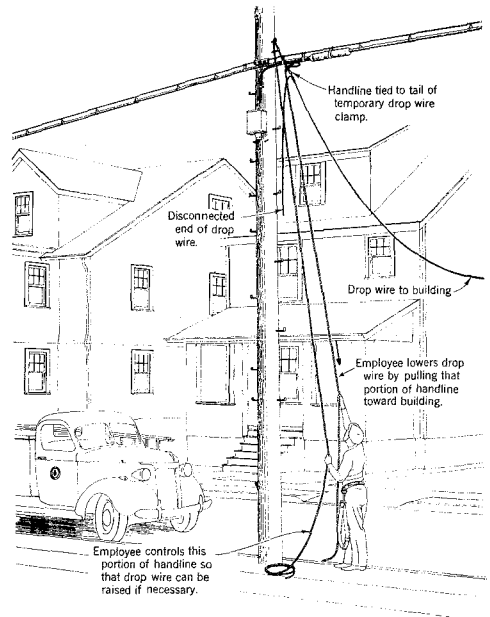


Fig. 1 – Lowering Drop Wire

#### Precautions

5.02 The following precautions shall be observed when lowering a drop wire attached to a span clamp in order that the work may be done in a safe manner.

- (a) Place the extension ladder at the location of the span clamp as outlined in 2.08.
- (b) When climbing the extension ladder to work at a span clamp, the strand is forced out of line. The distance the strand is deflected depends on the tension in the strand, the weight of the cable, and the combined weight of the man and ladder. Therefore, while the employee is climbing the ladder, it is important that he observe the effect of the strand deflection on all drop wires attached to the section of strand in which he is working. The principal conditions to be observed are:

- (1) Where drop wire crosses a street or highway, avoid placing additional sag in a drop wire span which would create a

## SECTION 462-800-311CA

traffic hazard, unless traffic is properly controlled.

(2) Where drop wire does not cross a street or highway, avoid placing excess tension in a drop wire span which may pull out the first building attachment, thereby causing property damage and sudden movement of the strand while the employee is climbing the ladder. See 6.04 for the method of releasing excess tension in a drop wire span.

**5.03** Lower the wire from the span clamp in accordance with the following sequence of operations:

- (1) Detach the drop wire first from the pole and lower this end of the wire run to the ground.
- (2) Coil the drop wire and place it on the ground near the ladder in order to avoid accidents resulting from vehicles striking it or pedestrians tripping on it.
- (3) Place a handline over the strand and lower the drop wire as outlined in Part 3, except that the handline shall be lashed to the lower rungs of the extension ladder if it cannot be fastened to a nearby pole or tree.

## 6. LOWERING TAUT WIRE

**6.01** The method outlined in this part covers the special precautions which shall be taken when lowering a taut drop wire span and it applies to the lowering of all taut wire spans whether or not they cross streets or highways.

### Taut Span from Pole

**6.02** When it is necessary to lower a taut drop wire span from a pole, proceed as follows:

- (1) Place a handline over the strand, guard arm, drive hook, or crossarm so that the end of the handline toward the building just reaches the ground.
- (2) Disconnect the drop wire from the terminal and remove the free end from the wirings on the pole.

(3) Place a temporary drop wire clamp on the wire to be lowered, about one foot out in the span. Seat the clamp firmly on the wire.

(4) Tie a loop of the handline securely to the tail of the temporary drop wire clamp.

(5) Return to the ground. Pull the long end of the handline sufficiently taut to remove tension from the original drop wire clamp and lash the handline securely to the base of the pole, thereby supporting the taut wire span by means of the temporary drop wire clamp and the lashed handline.

**Caution:** *Exercise care to avoid placing more tension in the drop wire span than is necessary to remove tension from the tail of the original drop wire clamp.*

(6) Climb the pole and check to ensure that the tension in the drop wire span has been removed from the tail of the original drop wire clamp.

(7) Cut the tail of the original drop wire clamp with pliers.

(8) Return to the ground. Untie the handline and slowly ease off the long end of the handline, thereby releasing excess tension in the taut drop wire span. When no vehicles or pedestrians are approaching, lower the wire span to the ground by pulling the short end of the handline. The long end of the handline should pass through the employee's hand in order that he can raise the wire quickly if necessary.

### Taut Span from Span Clamp

**6.03** The procedure outlined in Part 5 also applies to the lowering of a taut drop wire attached to a span clamp, except that the excess tension in the drop wire span shall first be released.

**6.04** Release the excess tension in the drop wire from the building end of the span as follows:

- (1) Remove the C knob or the SC wire clip and the associated loop of drop wire from the first building attachment. Do not remove the drop wire clamp which supports the wire span.

- (2) Attach a temporary guide loop to the first building attachment, such as shown in Fig. 2, to prevent the handline used in releasing the excess tension from becoming accidentally disengaged from the building attachment.
- (3) Place a temporary drop wire clamp on the wire to be lowered, about one foot out in the span. Seat the clamp firmly on the wire.
- (4) Place a handline over the first building attachment and through the temporary guide loop. Tie the handline securely to the tail of the temporary drop wire clamp.
- (5) Return to the ground. Pull the handline sufficiently taut to remove tension from the original drop wire clamp and lash the handline to a substantial and secure support near the base of the building.

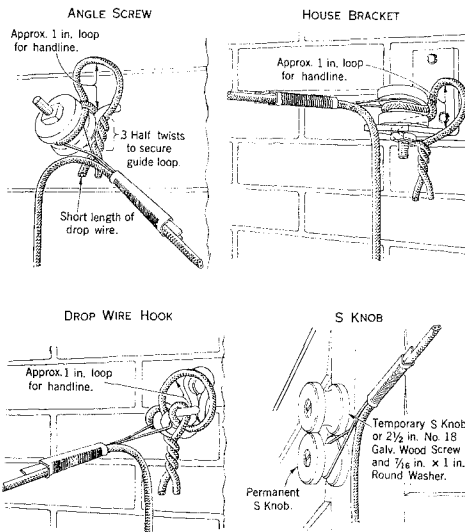


Fig. 2 – Temporary Guide Loop

**Caution:** Exercise care to avoid placing more tension in the drop wire span than is necessary to remove tension from the tail of the original drop wire clamp.

- (6) Check to ensure that the tension in the drop wire span has been removed from the tail of the original drop wire clamp.
- (7) Cut the tail of the original drop wire clamp with pliers.
- (8) Return to the ground. Untie the handline and slowly ease off the handline, thereby releasing excess tension in the taut drop wire span. Retie the handline to a substantial and secure support near the base of the building.
 

**Note:** If the amount of slack introduced into the drop wire span is not sufficient to release the excess tension, remove the wire from one or more of the building attachments beyond the first attachment and, if necessary, cut the wire in the building run.
- (9) Proceed as covered in Part 5 for lowering a normal wire span from a span clamp.

## 7. LOWERING WIRE ATTACHED TO TWO BUILDINGS

**7.01** The method described in this part shall be followed in lowering a drop wire span attached to two buildings.

- (1) Select the end of the drop wire span at which the following operations can be performed best.
- (2) Lower the drop wire run on the building up to the first attachment from which the wire span is to be lowered and remove the C knob or the SC wire clip and the associated loop of drop wire from this first attachment. Do not remove the drop wire clamp which supports the wire span.
- (3) Place a handline over the first building attachment so that the end of the handline toward the wire span just reaches the ground. Attach a temporary guide loop to the first building attachment around the handline as illustrated in 6.04 (2) to prevent the handline from becoming accidentally disengaged from the building attachment during the lowering operation.
- (4) Place a temporary drop wire clamp on the wire to be lowered, about one foot out in the span. Seat the clamp firmly on the wire.

- (5) Tie a loop of the handline securely to the tail of the temporary drop wire clamp.
- (6) Return to the ground. Pull the long end of the handline sufficiently taut to remove tension from the original drop wire clamp, lash the handline to a substantial, and secure support near the base of the building, thereby supporting the wire span by means of the temporary drop wire clamp and the lashed handline.
- (7) Remove the original drop wire clamp from the building attachment.
- (8) Return to the ground. Untie the long end of the handline and lower the wire span by pulling the short end of the handline.

## 8. RAISING WIRE LOWERED BY HANDLINE METHOD

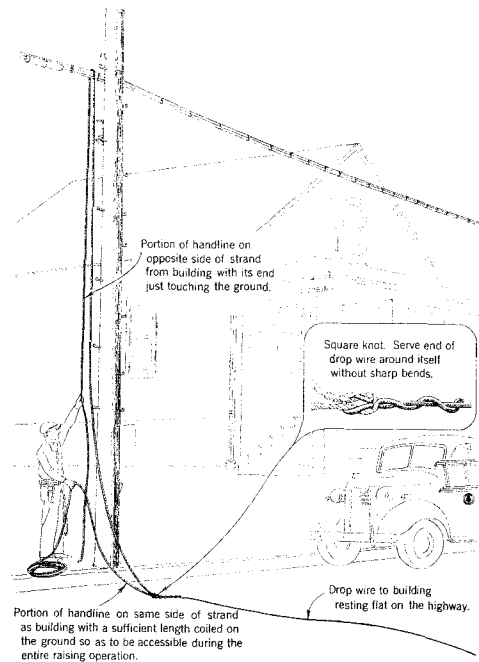
**8.01** When it is necessary to raise a drop wire that was lowered by the handline method, proceed as follows:

- (a) Where an intermediate portion of the original wire span is to be replaced or the entire original wire span is to be raised.

**Note:** The length of wire spliced in as an intermediate portion of the original wire span shall be approximately the same as that which it replaces in order that the drop wire clamp will be within reach of the employee after the wire span has been raised.

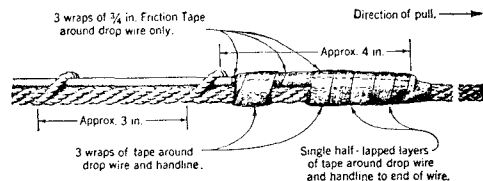
- (1) After the wire has been repaired, lay it along the ground between the building and the building side of the highway and coil the remaining length of wire.
- (2) When no traffic is approaching, carry the coil across the street or highway to the previously placed handline, paying out the wire so that it rests flat on the ground. If a metal or hard rubber-tired vehicle passes over the wire, pull the wire back to the building side of the highway. Inspect the wire for possible injury and replace any portions that are found to be damaged.
- (3) Tie the end of the drop wire to the handline as shown in Fig. 3 at a point in that

portion of the handline toward the building which will permit the employee to have access to both ends of the handline from his position on the ground during the entire raising operation.



**Fig. 3 — Raising the Drop Wire**

**Note:** If the handline has been placed over a drive hook or other support on which the square knot would snag, fasten the wire to the handline as shown in Fig. 4.



**Fig. 4 — Fastening Handline to Prevent Snagging**

(4) When no vehicles or pedestrians are approaching, raise the drop wire by pulling that portion of the handline on the opposite side of the strand from the building. The portion of the handline toward the building should pass through the employee's hand in order that he may be able to pull the wire to the ground quickly if necessary.

(5) After the drop wire has been raised to the approximate required height, tie the handline to the base of the pole or, if at a span clamp, to the lower rungs of the ladder.

(6) Climb the pole or, if at a span clamp, the ladder, and attach the drop wire to the pole or strand in a standard manner without removing the handline from the drop wire. When attaching the drop wire to a span clamp, bear in mind that the strand is forced out of line by the ladder resting against it and make any adjustments that are necessary to avoid excessive tension in the wire span when the employee is working from the ladder and also to ensure proper sag and clearance after removal of the ladder.

(7) Remove the handline from the drop wire and complete the connection in a standard manner.

(b) Where the entire original wire span or the end toward the pole or strand is to be replaced.

(1) On the building side of the street or highway, splice the end of the existing wire to the outer end of a coil of drop wire mounted on the drop wire reel.

**Caution:** *The inner end of the coil of drop wire shall be securely fastened to one of the springless spokes of the drop wire reel.*

(2) Coil up any excess length of wire on the drop wire reel.

(3) Proceed as in raising a new drop wire over a street or highway. See Section 462-400-205CA.

**8.02** When raising a drop wire between two buildings, provide as much sag as practicable in the wire span, and support the tension in the wire by means of a lashed handline before placing the second drop wire clamp.

## 9. RAISING WIRE LOWERED BY DROPPING METHOD

**9.01** When it is necessary to raise a drop wire that was lowered by the dropping method as outlined in Part 4, proceed as follows:

(a) Where an intermediate portion of the original wire span is to be replaced or the entire original wire span is to be raised.

**Note:** The length of wire spliced in as an intermediate portion of the original wire span shall be approximately the same as that which it replaces in order that the drop wire clamp will be within reach of the employee after the wire span has been raised.

(1) After the wire has been repaired, lay it along the ground between the building and the pole or span clamp location.

(2) Attach one end of the handline to the tail of the drop wire clamp. The length of the handline shall be greater than the distance from the ground to the drop wire attachment point.

(3) Loop the other end of the handline under the body belt as described in 2.05 and climb the pole or, if at a span clamp, the ladder.

(4) Place the handline over the strand, guard arm, drive hook, or crossarm from the side toward the building.

(5) Raise the drop wire to the approximate required height by pulling the handline over the strand or other support and then lash the handline to the pole or strand.

(6) Attach the drop wire to the pole or strand in a standard manner and then remove the handline. When attaching the drop wire to a span clamp, bear in mind that the strand is forced out of line by the ladder resting against it and make any adjustments that are necessary to avoid excessive tension in the wire span when the employee is working from the ladder and also to ensure proper sag and clearance after removal of the ladder.

(b) Where the entire original wire span or the end toward the pole or strand is to be replaced.

## SECTION 462-800-311CA

- (1) Splice the end of the existing wire to the outer end of a coil or drop wire mounted on the drop wire reel.

**Caution:** *Fasten the inner end of the coil of the drop wire securely to one of the springless spokes of the drop wire reel.*

- (2) Coil up any excess length of wire on the drop wire reel.
- (3) Proceed as in raising a new drop wire elsewhere than over a street or highway. See Section 462-400-205CA.

**Note:** If it is necessary to replace only a short length (not more than about 10 feet) at the free end of the drop wire, it may be found more convenient to splice in a length of wire of approximately the same length as that which it replaces and then place a drop wire clamp in the same relative position as that of the original clamp. Raise the repaired wire as outlined in 9.01 (a).

### 10. REPLACING WIRE NOT LOWERED FOR INSPECTION

**10.01** If it is obvious that an entire drop wire span requires replacement and conditions are such that it would be advantageous to pull the new wire into the span as the old wire is pulled out of the span, the method outlined in 10.02 may be followed, provided that:

- (a) The existing drop wire span has at least the minimum required clearance over streets or highways or over secondary electric service wires operating at less than 300 volts.
- (b) Specific approval to use this method has been obtained from the supervisor.
- (c) The operation of the drop wire reel can be observed from the handline location.
- (d) The drop wire reel can be located in a stable position so that when the tension in the wire span is transferred to the reel, it will not slide along the ground or fall over.
- (e) The existing drop wire span is not taut.
- (f) The existing wire does not cross over trolley or trolley-bus contact wires or over power wires or power cables operating at 300 volts or more.

**Caution:** *If all of the above conditions are not met, the workman shall follow the standard method for lowering an existing drop wire span and raising a new drop wire span.*

**10.02** If conditions permit pulling the new drop wire into place as the old wire is pulled out, proceed as follows:

- (1) Remove the C knob or the SC wire clip and the associated loop of drop wire from the first building attachment. Do not remove the drop wire clamp which supports the wire span.
- (2) Attach a temporary guide loop to the first building attachment, as illustrated in 6.04 (2), to prevent the replacing drop wire from becoming accidentally disengaged from the building attachment.
- (3) Place the drop wire reel near the foot of the ladder on the side away from the wire span and in a stable position.

**Caution:** *Fasten the inner end of the coil of drop wire securely to one of the springless spokes of the drop wire reel.*

- (4) Set the brake of the reel so that it will hold the tension in the wire span after it is transferred to the reel.
- (5) With the drop wire paying off from the bottom of the reel, pass the end of the wire over the first building attachment and through the temporary guide loop at this attachment.
- (6) Place a temporary drop wire clamp on the wire to be replaced about one foot out in the span. Seat the clamp firmly on the wire. Tape the front end of the temporary clamp so that it will not foul on the strand, guard arm, or crossarm.

**Note:** If the drop wire is to be pulled over a drive hook or other support on which the temporary clamp would snag, fasten the end of the wire from the drop wire reel securely to the wire in the span in a manner such as illustrated in Fig. 4.

- (7) Tie the end of the wire from the drop wire reel securely to the tail of the temporary drop wire clamp.

- (8) Reel up all slack between the drop wire reel and the temporary drop wire clamp so that tension is removed from the original drop wire clamp.
- (9) Go to the other end of the drop wire span and lash one end of the handline to the base of the pole or, if at a span clamp, to the lower rungs of the ladder or to a nearby pole or tree.
- (10) Loop the other end of the handline under the body belt as described in 2.05 and climb the pole or ladder.
- (11) Disconnect the drop wire from the terminal and remove the free end from the wiring rings on the pole.
- (12) Place a temporary drop wire clamp on the free end of the drop wire (not in the span) to be replaced. This arrangement eliminates the necessity of pulling the temporary drop wire clamp over the strand, guard arm, drive hook, or crossarm on which it may become fouled.
- (13) Tie a loop of the handline to the tail of the temporary drop wire clamp so that the lashed end of the handline is sufficiently taut to remove tension from the original drop wire clamp.
- (14) Remove the original drop wire clamp from the drop wire at the pole or span clamp, thereby leaving the wire supported by means of the temporary drop wire clamp and the lashed handline.
- (15) Return to building, check to ensure that tension has been removed from the original drop wire clamp, and then cut the wire to be replaced behind the temporary drop wire clamp with pliers.
- (16) Return to the pole or span clamp location, untie the handline and, while standing on the ground, pull the new wire into the span, observing the drop wire as it feeds from the drop wire reel to make sure that the brake maintains sufficient tension to prevent the wire from sagging an excessive amount.
- (17) When a sufficient length of new wire has been pulled over the strand, guard arm, drive hook, or crossarm for terminating or splicing purposes, lash the old wire to the base of the pole, or to the lower rungs of the ladder. The wire in the crossing span shall be reasonably slack so that there will not be undue tension in the span when placing the drop wire clamp at the first building attachment.
- (18) Fasten the new wire span to the first building attachment with a drop wire clamp and then remove the temporary guide loop.
- (19) Fasten the new wire span to the pole or strand attachment in the standard manner without removing the old wire which was used as the pulling line. When attaching the drop wire to a span clamp, bear in mind that the strand is forced out of line by the ladder resting against it and make any adjustments that are necessary to avoid excessive tension in the wire span when the employee is working from the ladder and also to ensure proper sag and clearance after removal of the ladder.
- (20) Detach the old wire from the new wire and complete the connection in a standard manner.





## DROP AND BLOCK WIRING

### LOWERING AND REPLACING DROP WIRE

#### VOLTAGES OF 300 TO 750 INVOLVED

#### 1. GENERAL

**1.01** This section covers the methods of lowering and replacing drop wire under the conditions usually encountered where the drop wire crosses over trolley or trolley-bus contact wires or over power wires or power cables operating at 300 to 750 volts.

**1.02** This information was formerly covered in Section 625-800-312CA (G32.415.2) which is cancelled.

**1.03** The basic principles presented in this section should also be observed in those cases where conditions necessitate a departure from the usual procedures.

*Note:* If, for any reason, it is necessary to lower or replace a drop wire crossing over any power wires or power cables operating at more than 750 volts, refer the case to your supervisor for specific instructions.

**1.04** The methods outlined herein are such that the drop wire is lowered by means of a handline while the employees remain on the ground and so perform the work that the drop wire does not come in contact with the trolley contact or power wires or power cables during the entire lowering operation. These methods are also intended to avoid the possibility of accidents caused by releasing tension from a building or strand attachment while working from a ladder or as the result of vehicles striking the wire or the handline as it is being lowered to the ground.

**1.05** Refer to Section 462-800-311CA for the methods of lowering or replacing a drop wire where no trolley or trolley-bus contact wires, or power wires or power cables operating at 300 volts or more are involved. The methods of placing drop wire are covered in Sections 462-400-205CA and 462-400-206CA.

#### 2. PRECAUTIONS

**2.01** In general, two men shall be employed when lowering or replacing a drop wire over trolley or trolley-bus contact wires, or over power wires or power cables operating at 300 to 750 volts. Obtain additional assistance before lowering or replacing a drop wire over streets, highways, or elsewhere if traffic, tree, or other conditions are such that two men cannot do the work safely.

**2.02** Insulating gloves shall be worn by all employees when lowering or replacing a drop wire over trolley or trolley-bus contact wires, or over power wires or power cables and until the crossing span has been completely removed or replaced in a standard manner.

**2.03** The handline used for lowering or replacing a drop wire under the conditions outlined in this section shall be free from metallic strands and shall be dry. A wet handline must not be used in the vicinity of power circuits operating at 300 volts or more, except as indicated below.

*Exception:* When it is necessary to maintain service or establish emergency service during rainstorms, a wet handline may be used over trolley or trolley-bus contact wires and other power circuits operating at 300 to 750 volts, provided that insulating gloves, rubber boots, and rubber raincoats are worn.

**2.04** When it is necessary to carry a handline up a pole or ladder, double the end of the handline back on itself for a distance of approximately 1 foot and place this loop under the right or left side or back of the body belt or in such other position that the handline will be released readily if it is placed under tension while the employee is climbing the pole or ladder.

## SECTION 462-800-312CA

**2.05** Never release the drop wire supports from a wire span while working inside the angle formed by the wire.

**2.06** Avoid working from a ladder placed against a building with the side rails crossing a wire run or in any other position where movement of the wire, due to loosening of the attachments, would cause an accident.

**2.07** When a drop wire attached to a span clamp is to be lowered or replaced, place the foot of the extension ladder on the field side of the suspension strand and not in the street or highway. If there is no street or highway adjacent to the span clamp, place the ladder against the opposite side of the strand from the drop wire run to the building.

**2.08** If conditions are such that the handline, or the drop wire to which it is attached, may become disengaged from a drive hook or crossarm or may slide along the strand or guard arm while doing the work outlined in this section, the handline or drop wire shall be enclosed with a temporary guide loop. This loop shall consist of a short length of wire or houseline placed over the handline or drop wire with the ends of the guide securely tied as follows.

- (a) Drive Hook: Tie one end to the vertical portion of the drive hook and lash the other end to the pole.
- (b) Crossarm: Tie the ends to adjacent pins or insulators.
- (c) Guard Arm: Tie the ends to the guard arm on each side of the handline or drop wire.
- (d) Strand: Tie the ends to the strand or the strand and lashed cable on each side of the handline or drop wire, or place the handline or drop wire through the hook of a C span clamp.

### 3. LOWERING WIRE OVER TROLLEY CONTACT OR POWER WIRES OR POWER CABLES

**3.01** The procedure outlined below shall be followed when the drop wire span is to be permanently removed from plant, or lowered for inspection, repair, or replacement. Lower only one wire span at a time.

(1) Man No. 1: Loops one end of the handline under the body belt as described in 2.04 and climbs the pole or, if at a span clamp, the ladder. The handline shall be of a sufficient length to reach from the ground to the strand, guard arm, drive hook, or crossarm and then horizontally to about 25 feet beyond the trolley contact or power wires or power cables to ensure that the end of the drop wire can be pulled at least 10 feet beyond the power circuits.

*Caution: If a span clamp is involved, bear in mind that the strand is forced out of line by the ladder resting against it and take any steps that are necessary to prevent the drop wire from sagging onto the trolley contact or power wires or power cables while climbing and working on the ladder. Care should also be taken to ensure that there will be adequate clearance between the employee and power wires or cables when the strand is deflected by the weight of the employee on the ladder.*

(2) Man No. 1: Places a temporary drop wire clamp on the wire to be lowered, about 1 foot out in the span; seats the clamp firmly on the wire.

(3) Man No. 1: Places the handline over the strand, guard arm, drive hook, or crossarm and ties the end securely to the tail of the temporary drop wire clamp.

(4) Man No. 2, standing on the ground, grasps the free end of the handline and pulls it sufficiently taut to remove the tension from the original drop wire clamp and then lashes the handline securely to the base of the pole or, if at a span clamp, to the lower rungs of the ladder (see note). Man No. 1 on the pole or ladder then cuts the drop wire approximately 6 inches behind the temporary drop wire clamp, thereby leaving the drop wire span supported by means of the temporary clamp and the lashed handline.

*Note: If a taut drop wire span is involved, Man No. 2 on the ground grasps the free end of the handline and pulls it sufficiently taut to support the wire span, snubbing the handline if necessary. Man No. 1 cuts the tail of the original drop wire clamp with pliers. Man No. 2 slowly eases off the handline, thereby releasing excess tension in the taut*

wire span and then lashes the handline to the base of the pole or the lower rungs of the ladder.

(5) Man No. 1 and Man No. 2 both go to the opposite or building end of the drop wire span.

(6) Man No. 1 cuts the drop wire in the building run at a point where the end of the wire can be reached from the ground and then frees the wire from all intermediate attachments between the cut end of the wire and the first building attachment.

(7) Man No. 2 removes the C knob or the SC wire clip at the first building attachment and then places a temporary guide loop at the first building attachment, around the drop wire, such as shown in Fig. 1, to prevent the wire from becoming accidentally disengaged from the building attachment as it is being pulled over the power circuits.

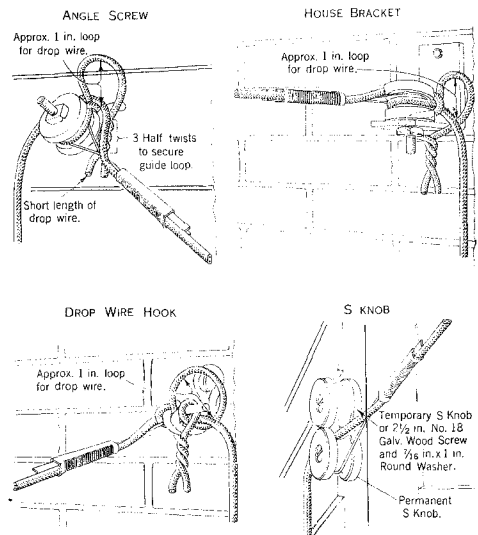


Fig. 1 — Temporary Guide Loop

(8) Man No. 1 on the ground holds tension in the drop wire while Man No. 2 removes the original drop wire clamp from the first building attachment. Man No. 1 continues to hold tension in the wire span to prevent it from coming in contact with the trolley contact or power wires or power cables.

(9) Man No. 2 returns to the other end of the wire span, unties the handline and keeps the drop wire taut while feeding it to Man No. 1 who pulls it over the power circuits and coils the drop wire as it is pulled out of the span.

(10) When the end of the drop wire has been pulled at least 10 feet beyond the trolley contact or power wires or power cables, and no traffic is approaching, Man No. 2 carefully releases the handline, allowing it to fall on the power circuits and then immediately goes into the street or highway to control traffic, assisted by the police if necessary.

(11) Man No. 1 pulls the remainder of the drop wire and the handline to the building end of the span and away from the street or highway.

#### 4. REPLACING WIRE OVER TROLLEY CONTACT OR POWER WIRES OR POWER CABLES

**4.01** When a drop wire crossing over trolley or trolley-bus contact wires or over power wires or power cables operating at 300 to 750 volts is lowered for inspection, repair, or replacement, it shall not be reused in the crossing span. Place new wire in the crossing span in accordance with the methods outlined in Section 462-400-206CA. If the wire that has been removed from the crossing span is in good condition, splice it to the end of the wire on the drop wire reel for reuse at a location where the wire will not cross over trolley or trolley-bus contact wires, or over power wires, or power cables.



## DROP AND BLOCK WIRING TESTING AND FAULT LOCATING

CONTENTS	PAGE
1. GENERAL . . . . .	291
2. GROUNDS . . . . .	292
3. OPENS . . . . .	296
4. SHORT CIRCUITS . . . . .	298
5. CROSSES . . . . .	300
6. 81A TEST SET . . . . .	302
7. USE OF 81A TEST SET . . . . .	302
8. TESTING FOR SHORTED CONDUCTORS . . . . .	303
9. TESTING FOR OPEN CONDUCTORS . . . . .	303
10. TESTING FOR LOW RESISTANCE GROUNDED CONDUCTORS . . . . .	303
11. TRACING NON-WORKING CONDUCTORS . . . . .	303

### 1. GENERAL

1.01 This section is reissued to revise reference section numbers.

1.02 In locating trouble in the drop and block wire plant, much time and effort can be saved by careful analysis and systematic procedure by the workmen. Certain types of trouble are readily apparent and can be detected by a visual inspection while other types present very little external evidence of their existence and require electrical tests to locate them.

1.03 A thorough knowledge of plant conditions throughout the territory involved greatly assists a workman in locating trouble. Frequently the knowledge of an unsatisfactory plant condition for example, unsatisfactory tree conditions, etc., which has not as yet been corrected suggests the first point to examine for the trouble.

1.04 Alertness in noting foreign construction operations that might interfere with the telephone plant will assist, in many instances, in quickly locating the cause of the trouble. Consultation with the party in charge of the operations, before they have progressed to a point where the telephone plant is endangered, will frequently prevent any interference with the telephone service. When it is noted that the telephone plant will interfere with the progress of building operations or other construction work, the condition should be corrected or reported in accordance with local instructions.

1.05 In order that the workman may proceed intelligently and efficiently to locate the cause of the trouble, he should have the following information:

- (a) Telephone number.
- (b) Name and address of subscriber, given in sufficient detail to permit ready identification of the premises of the subscriber (such as apartment number, floor, room number, etc.).
- (c) Cable numbers, pair numbers and terminals. Where terminals are not stenciled or otherwise marked, binding post identification.
- (d) Number of pole on which drop or drops terminate (on other than cable lines), if available.
- (e) Transmission zone.
- (f) Nature of trouble as diagnosed by test or from report.
- (g) Whether or not station is out of service.
- (h) Other items of special information as:
  1. Any indication (such as the operation of protective equipment) that there may be foreign current upon the line.
  2. That special effort is necessary to restore service quickly as to hospitals or doctor's offices, etc.

## SECTION 462-800-500CA

3. That trouble of similar nature has recently occurred on the same line.
4. That trouble is of such a nature that the entire line from the terminal to the station should be inspected.

**1.06** If, after securing the above information, the workman is aware of conditions in the outside plant which might have caused the trouble, his investigation should be begun by a visit to the points where these conditions are known to exist. If nothing is found at these points and then appropriate tests are made which determine that the trouble is in drop or block wire, the investigation should be continued in accordance with the methods given in detail for specific types of faults. (See parts 2, 3, 4, and 5.)

**1.07** Hand test sets can ordinarily be used on common battery circuits and magneto test sets on magneto or local battery circuits, to make the necessary electrical tests on the line to locate faults. These sets should be so employed that a trouble may be located quickly without making unnecessary tests. Proper utilization of the test set will enable the repairman to locate many troubles without enlisting the aid of the test deskman or the operator. Test sets employed should be provided with leads ending in approved clips equipped with test points so that contacts may be made with conductors by piercing the insulation with these points. No other method of establishing contacts with conductors through the insulation of the wires should be used. When tests are being made which depend upon a click being heard in the receiver of the test set be sure that the click is heard both upon the make and the break of the contact.

**1.08** When it is necessary, in locating a fault in drop or block wire, to open the line at various points for the purpose of making a test, first select points where disconnections can readily be made such as binding posts, bridging connectors, etc. In general, no wires shall be cut until tests have isolated the fault between two adjacent such points. Then after an inspection has been made if further tests are required to locate the fault, one conductor of the wire may be cut to make the test.

**1.09** Before leaving a line upon which work has been done or repairs have been made, suitable tests should be made in accordance with local instructions to determine that the line is in good working condition.

**1.10** Whenever there is any indication (such as the operation of protective equipment) of the presence of foreign current upon a line, suitable precautions shall be taken to prevent the possibility of electric shock being sustained by the workmen.

**1.11** The detailed procedures to be employed to locate the various types of faults in the drop and block wire plant are outlined in the following parts of this section. All repairs should be made in accordance with the provisions of Section 462-800-305CA.

## 2. GROUNDS

**2.01** Two types of grounds are commonly encountered in the drop and block wire plant, namely,

(a) **Low Resistance Ground.** This type of ground is usually the result of a complete breakdown of the insulation on a conductor due to deterioration or abrasion and contact with grounded objects such as guys, suspension strand, ground wires, rain spouts, conduit, etc., establishing a low resistance path to ground.

(b) **High Resistance Ground.** This type of ground may be caused by complete or partial breakdown of the insulation on a conductor and the establishment of a poor contact with grounded objects so that the path to ground is of high resistance, except in wet weather. It may also be caused by complete breakdown of the insulation on a conductor and contact with objects such as wood poles, trees, buildings, etc., that do not afford a low resistance path to ground. Troubles of the latter class are frequently of varying intensity, appearing usually during wet weather and usually must be located either under wet weather conditions or by a visual inspection for the point where the insulation is faulty.

## Common Battery Circuits—Locating Grounds in the Drop and Block Wire Plant

### Low Resistance Grounds

**2.02** Information as to which side of the line is grounded is important. This is especially true if the cause of the fault is not found by visual inspection and tests must be resorted to, to more accurately determine its location. This information, if it is available, should be obtained when the trouble is referred for clearing. If it is not available the side that is grounded should be determined during the tests that are necessary to isolate the trouble to a drop or block wire.

**2.03** The drop or block wire in which the fault is located should be found by the following test. Disconnect all drop, block or bridle wires bridged to the grounded line from the binding posts in the cable terminal, so placing the wires that they may be reconnected in their original position upon completion of the test. (If it is known which side of the line is grounded it is necessary to disconnect only the wires on the grounded side of the line.) Connect one clip of the test set to a suitable ground such as the metal terminal case or suspension strand and touch the other clip to the binding post on which battery normally should be found. (See fig. 1). If no battery click is heard in the receiver, touch the other binding post. (If still no battery click is heard there is other trouble on the line which must be cared for before proceeding with the locating of the trouble in the drop or block wire.)

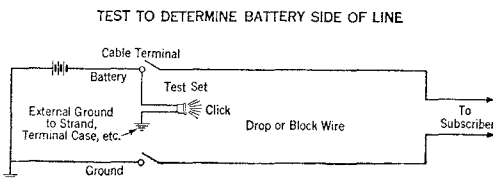


Fig. 1

When a battery click is heard connect the clip to the binding post carrying battery and remove the other clip from the external ground. Touch this clip to the conductors of the drop wire. A battery click will be heard in the receiver when the grounded wire is touched. (See figures 2 and 3.)

### GROUND SIDE GROUNDED

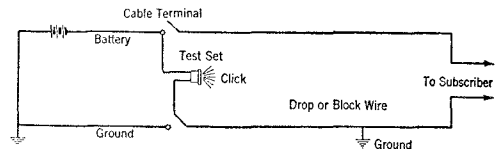


Fig. 2

### BATTERY SIDE GROUNDED

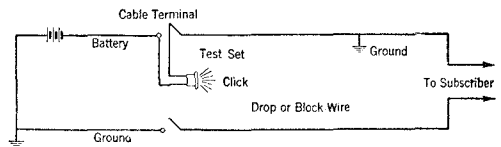


Fig. 3

Note whether or not the insulation upon the grounded wire carries a tracer. This knowledge will be helpful if subsequent tests at other points are necessary (unless an intervening splice has been made in a non-standard manner and the tracer reversed). Before reconnecting the wires disconnected to make this test, be sure to test every wire separately to determine whether or not it is clear.

**2.04** After the fault has been isolated to a particular drop or block wire, a careful inspection for the conditions causing the ground should be made before testing at other points to further isolate the fault. This is desirable as low resistance grounds in the drop and block wire plant are usually caused by conditions that are readily discovered by visual inspection.

**2.05** If a visual inspection of the wire that is grounded does not disclose the fault, further tests are necessary to definitely locate the source of the trouble. In making these tests, if the ground is on the battery side of the line:



- (a) Open that side of the line.
- (b) Then attach one clip of the test set to the binding post or wire end on the central office side of the open.
- (c) Touch the end of the wire that leads away from the central office with the other clip. (See Figure 4.)

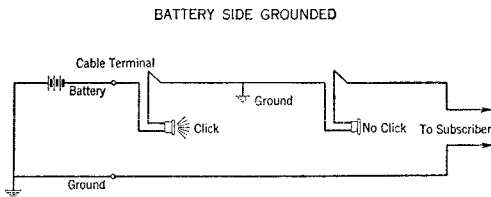


Fig. 4

However, if the external ground is on the ground side of the line:

- (a) Open that side.
- (b) Establish a contact with the battery side of the line by attaching a clip of the test set to a binding post or if the test is at a point in the wire by piercing the insulation of the conductor carrying battery with the point of the test set clip.
- (c) Touch the exposed end of the wire that leads away from the central office with the other clip. (See Figure 5.)

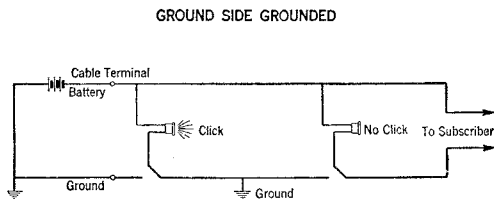


Fig. 5

The test, if on an individual line, will indicate by a click in the receiver that the ground is located toward the station or by absence of a click that it is located in the direction of the central office. On a party line the click indicates that the ground is located in the portion of the wire that is directly affected by the test and absence of the click indicates that the ground is either toward the central

office or in a portion of the wire which is not affected by the test at that particular point.

**2.06** In locating grounds on party lines it is desirable, when possible, to start at a point where the circuits to all parties are common and are carried on a single pair of conductors. Then test the wires to each individual party until the wire that is in trouble is found.

#### High Resistance Grounds

**2.07** Trouble of this type is frequently of varying intensity and in some instances appears only under severe moisture conditions. Often the trouble is caused by the cumulative effects of lowered insulation at several entirely different points in the drop or block wire plant and this condition is frequently found on party lines. If the resistance of the contact to ground is high, it frequently is difficult, if not impossible, to obtain a positive indication by testing with the hand test set as outlined under low resistance grounds. In this case it is advisable to first determine that the fault is not located toward the central office by disconnecting the drop or block wire at the cable terminals and having the circuit tested from the central office when testing facilities are available. On a party line if this disconnection reduces the leak to ground but does not entirely clear the line, leave the wires disconnected until after similar tests have been made where other wires are bridged to the line so that all the conditions contributing to the leak may be isolated and cleared. On party lines where the disconnection has either cleared the fault or has had no effect on the leak to ground or on individual lines, reconnect the wires immediately after the test has been concluded and the result reported. After the wire or wires which cause or contribute to the leak are determined, the fault usually may be found by making a careful visual inspection. If the points of faulty insulation are not found it is necessary to further isolate them by opening the faulty conductor at various points and having the circuit tested from the central office when testing facilities are available.

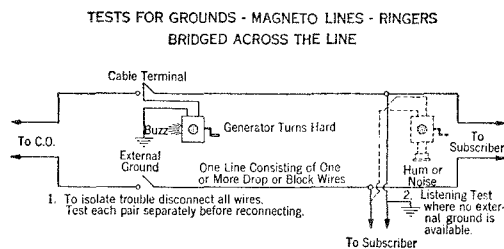
*Note:* Where leaks to ground exist at several points due to faulty insulation on different sides of the line the trouble may be referred to the workman as a short and a ground. This possibility should be understood when starting to clear a trouble so referred.

### Magneto or Local Battery Circuits—Clearing Grounds in the Drop and Block Wire Plant

**2.08** A high resistance ground on a magneto circuit usually does not have as serious an effect on service as would a similar ground on a common battery circuit. For this reason the existence of high resistance grounds on magneto lines frequently is not detected until the fault has developed so that the resistance of the path to ground has become low. Therefore, the methods outlined in the following paragraphs pertain mainly to locating low resistance grounds. When a high resistance ground does interfere with the proper operation of a line it may be necessary in order to locate the fault to disconnect the wires and have the circuit tested from the central office when testing facilities are available. (See Paragraph 2.07.)

**2.09** Two of the more commonly used tests with the magneto test set that are employed in magneto areas to locate grounds in the drop and block wiring are usually termed "Grounding Test" and "Listening Test." Their application is described in the following paragraphs.

**2.10** Where it is possible to ground one lead of the test set on a metal terminal case, messenger strand, anchor guy, etc., the grounding test is usually effective in isolating the fault to a particular portion of the drop or block wire. (See Figure 6.)



**Fig. 6**

To make this test:

- (a) Disconnect the drop or block wire at a convenient point.
- (b) Connect one clip of the test set to a suitable ground such as the metal terminal case, suspension strand or strand of an uninsulated anchor guy and connect the other test clip to one of the disconnected wires.

- (c) Turn the handle of the generator.

If the generator turns hard and the buzzer operates, the trouble is in the portion of the wire tested. In areas where the ringers are not grounded, if the generator turns freely and the buzzer does not operate, the wire tested is clear of ground. In selective ringing areas where the ringers are grounded, if the generator turns normally and the buzzer operates as on a clear line, the wire tested is clear. If the fault is not indicated, repeat this test with the test clip connected to the other disconnected wire. If these tests do not indicate that the trouble in the portion of the wire tested the test should be repeated in any other portion of the drop or block wire which was not affected by the test at this point.

**2.11** Except in areas where selective ringing is used, when the ground has been isolated to a particular portion of the drop or block wire, before reconnecting the wires connect one lead of the test set to each wire and closely observe the sound in the receiver. This will be helpful in estimating the type and severity of the faults and will assist when subsequent tests are necessary at points where no external ground is available and the listening test must be entirely depended upon.

**2.12** Grounds affecting the telephone circuit vary considerably in resistance, depending upon the extent of the breakdown of the insulation and the nature of the contact that causes the external ground. The sounds produced in the receiver vary according to the nature of the contact. Solid grounds usually are indicated by a steady hum. Grounds caused by moisture intensifying what would normally be a light leak generally produce rasping or fluttering noises. Lines grounded by contact with guys, cable sheath, suspension strand, rain spouts, etc., are frequently very noisy due to the imperfect contact afforded by dirty or corroded surfaces. Therefore, when applying the listening test this factor should be given careful consideration.

**2.13** To make the listening test (see Figure 6) disconnect both conductors of the drop or block wire at a point where the disconnection can conveniently be made. Connect the leads of the test set to the two conductors on the station side of the disconnection and listen for noise in the receiver. If the line is noisy, a ground is located in the portion of the circuit tested. If no noise is detected the disconnected wires should be reconnected and the

same test repeated in the other portions of the circuit that were not affected by the test at this point. When the portion of the wire that the trouble is in is found, make a careful inspection to determine the cause. If the cause is not found by inspection continue to isolate the fault until its possible location is limited to such a small portion of the wire that finding the exact location is less economical than replacing the section of the wire.

**2.14** In areas where selective ringing is employed and the station ringers are connected to ground the listening test must be applied in the following manner: (See Figure 7.)

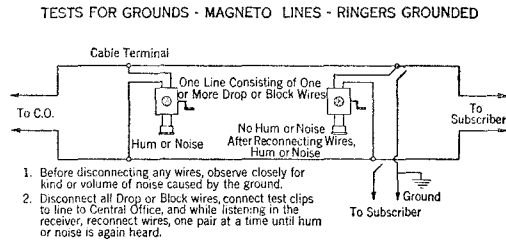


Fig. 7

(a) Disconnect both conductors of the drop or block wire or wires at a point where the disconnection can be conveniently made.

(b) Connect the two leads of the test set to the two conductors on the office side of the disconnection and listen in the receiver for noise.

(c) If no noise is detected reconnect the disconnected wires, one pair at a time, and listen in after each reconnection. When the grounded pair is reconnected this will be indicated by the consequent noise on the line and a further investigation should be made of the wire in this portion of the circuit to locate the trouble by inspection and if necessary by further tests of the same nature.

### 3. OPENS

**3.01** Opens in the drop and block wire plant are of three classes, namely:

(a) *Opens*. A complete open in a line is usually due to a break in one or both conductors of a drop or block wire, to a wire disconnected from a binding post or bridging connector or

to an improper or split pair connection at a cable terminal.

(b) *Intermittent Opens*. The common causes of an open of this type are loose connections at binding posts or bridging connectors, improperly made splices, wires corroded through, kinks, etc.

(c) *High Resistance Connections*. High Resistance connections are ordinarily caused by improper cleaning of wires before attaching them to binding posts, or bridging connectors, or by the formation of corrosion on wires, binding posts, nuts and washers.

Opens of the first class are ordinarily easily recognized and are usually referred to the workman as such. High resistance connections causing only poor transmission and noise and not causing cut-outs are often not identified as opens and therefore are not referred to the workman as such.

### Common Battery Circuits—Locating Opens in the Drop and Block Wire Plant

#### Opens

**3.02** To locate an open in the drop or block wire plant, isolate the fault by making successive tests at different points in the line with the hand test set. (See Figure 8.)

TEST FOR LOCATING AN OPEN

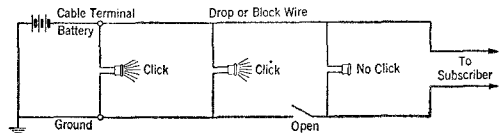


Fig. 8

To make the test, bridge the test set across the line. If a battery click is heard in the receiver on the make and on the break of the contact the open is away from the central office. If these clicks are not heard it is situated toward the central office. When clicks are heard on one test and on the test at the next point in the line no clicks are heard the fault is located between the points at which these two tests were made. After the fault has been isolated to one span or section, the wire in this span or section should be carefully examined, if necessary lowering the wire to do so.

Then if the fault cannot be found it should be eliminated by replacing the wire in that span or section. When locating an open the test set should be bridged across the line on the far side of any wire support on every test. If the trouble is at a wire support, adherence to this instruction will result in the direction in which the fault is situated changing on the test that is close to the support where the wire is in trouble. Then the verification that the fault is at the support consists of repeating the test on the near side of the support. During the tests, wires should be shaken as described in paragraph 3.03.

#### Intermittent Opens

**3.03** Intermittent opens in the drop and block wire are frequently difficult to locate and generally require a close inspection. If it is not detected by the inspection, resort to tests to locate the fault. When making a test on the line the wires toward the central office should be moved at knobs or other supporting fixtures and the wire in the span or section toward the central office should be shaken. A succession of battery clicks or a fluttering noise in the receiver indicates that the open is near to the point of movement and it ordinarily can then be found by a careful inspection. Check all connections at binding posts, bridging connectors, etc., to be sure that they are tight.

#### High Resistance Connections

**3.04** High resistance connections are generally indicated by noise and occasionally by cut-outs. Connections may appear tight and in good condition on visual inspection and yet the contact afforded may be so poor that noise is introduced into the circuit. The cause of this type of trouble ordinarily can be located by bridging the test set across the line near the various connections on the side away from the source of battery and listening for noise. Moving the wires at connections or tightening screws or locknuts may clear the trouble but to prevent its recurrence all wires should be removed at the connecting point found faulty and thoroughly cleaned before replacing. Where the trouble is not definitely found at any connection, the wires should be removed, cleaned and replaced at all binding posts or bridging connectors, etc. When the trouble is at the binding posts of a cable terminal and the nuts and washers are found dirty and corroded, the spinning should be removed from the top of the binding post with

the binding post cutter and the nuts and washers should be replaced with new ones before reestablishing the connection.

#### Magneto or Local Battery Circuits—Locating Opens in the Drop and Block Wire Plant

##### Opens

**3.05** When testing to locate an open in the drop or block wiring in areas where the ringing is selective and the ringers are not bridged across the line, the magneto test set should be bridged across the affected line by placing one test clip on one conductor and the other test clip on the other conductor of the pair. Place the test set switch in the proper position for calling and spin the handle of the generator. If the generator turns as it normally would on a clear line and the buzzer operates the open is not between the central office and the point at which the test is being made. If the generator turns freely and the buzzer does not operate the open is toward the central office. (See Figure 9.) By properly repeating this test at suitably selected points, the open may be definitely located. (Follow the principles that are outlined in paragraph 3.02.)

TESTS FOR OPENS - MAGNETO LINES - RINGERS GROUNDED

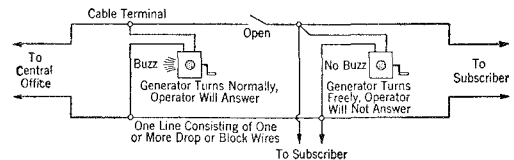


Fig. 9

**3.06** In areas where the ringers are bridged across the line it usually is advisable to disconnect one side of the line at a binding post or bridging connector and in order to avoid calling the operator unnecessarily, test away from the central office. Place one clip of the test set on the end of the disconnected wire and connect the other clip to the other side of the line. With the test set switch in the proper position for calling, spin the handle of the generator. If the generator turns as it normally would on a line in good working condition and the buzzer operates it indicates:

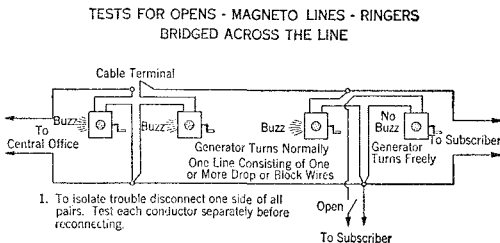
**SECTION 462-800-500CA**

- (a) On an individual line that the circuit to the subscriber's station is not open.
- (b) On a party line that a circuit is closed to at least one subscriber's station.

If the generator turns freely and the buzzer does not operate it indicates:

- (c) On an individual line that the open is located between the point at which the test was made and the subscriber's station.
- (d) On a party line (if only one open exists) that the open is located between the point at which the test was made and the point where the first party is bridged to the line.

In order to determine the condition of the line between the point of the test and the central office, remove the clip from the end of the disconnected wire and place it upon the binding post or bridging connector from which the wire was disconnected and repeat the test. If the generator turns normally, the buzzer operates and the operator answers, the circuit to the central office is closed. If the operator fails to answer even though the generator and buzzer operate normally, the open is located between the point of the test and the central office. (This latter condition would obtain if a party whose circuit was intact was bridged to the line between the point of the test and the central office.) The open may be definitely located by repeating this test at properly selected points. (See Figure 10.)



**Fig. 10**

**Intermittent Opens**

**3.07** In the case of intermittent opens a test similar to that described in paragraph 3.02 can often be used to advantage. As it involves depending upon the test set battery and receiver, these equipment items must be in first class condition. In selective ringing areas the connection should be established as in paragraph 3.05. A battery click on the make and on the break of the circuit indicates that the line to the central office is closed. Rasping or fluttering noises in the receiver or the absence of a click indicates that the trouble is between the testing point and the central office. While making this test, move or shake the wire in the manner that is outlined in paragraph 3.03. In areas where the ringers are bridged across the line the connections should be established as in paragraph 3.06 and the direction of the open can be determined by listening in the receiver at each test. Under certain conditions, such as where the line is very long or where the circuit remains open for a reasonably long period, it may be found desirable to test with the hand generator as for dead opens.

**3.08** When the intermittent open cannot be located by the use of the test set and testing facilities are available in the central office, call the office on the affected line and request that the circuit be tested. The condition of the circuit to the point at which the test set is bridged to the line should indicate whether the trouble is located between that point and the central office. Repetition of this procedure at suitably selected points should result in the determination of two points in the line between which the conditions change and indicate that the fault is located between these two points. After this has been done make a careful visual inspection, if necessary with the wire lowered, which usually will result in finding the fault. If the fault is not found replace the wire in this section.

**4. SHORT CIRCUITS**

**4.01** Short circuits in drop and block wiring are of two general classes as follows:

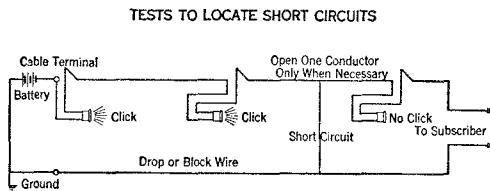
(a) Low resistance short circuits. These are due to a complete breakdown of the insulation between the two wires and the establishment of a low resistance path from one wire to the other. Frequent causes are injury to or deterioration of insulation at supporting fixtures, abrasion at knobs, at rings and at contacts with poles, trees, buildings, etc., and injury due to interference by foreign workmen, building operations, etc.

(b) High resistance short circuits. These are due to the establishment of a high resistance path between the two wires, caused by either a partial breakdown of the insulation or a complete breakdown of the insulation which has resulted in only a poor or high resistance contact between the wires. The usual causes for this type of short circuit are similar to those given for the first type, differing only in that the deterioration of or injury to the insulation is less severe.

#### Common Battery Circuits—Locating Short Circuits in the Drop and Block Wire Plant

##### Low Resistance Short Circuits

**4.02** In locating a low resistance short circuit in the drop or block wire plant first isolate the fault to a particular portion of the wire. To do this disconnect one side of the line at various convenient points such as at binding posts, bridging connectors or protectors and connect the test set in the line. (See Figure 11.)



**Fig. 11**

If a battery click is heard on the make and on the break of the connection the short circuit is located away from the central office. If no click is heard it is in the portion of the circuit toward the central office. When the clicks are heard at the point one test is made and are not heard at the point the next test is made, the fault is located between these two points.

**4.03** After the fault has been isolated to a particular portion of the wire, make an inspection of this section, noting especially the condition at each wire support. Location of the fault is facilitated if, while making this inspection, the test set is bridged across the line near each wire support and the wire is moved at the support and in the adjacent spans. If this disturbance of the wire causes the short circuit to shake out even momentarily, this will be indicated by a fluttering noise or a series of clicks in the receiver. Then, by making a careful inspection of the wire near the point it was moved, the fault can usually be found.

**4.04** If the short circuit cannot be located by the inspection, it becomes necessary to further isolate it to a particular span or section by repeating at various points, the test outlined in paragraph 4.02, cutting one conductor of the wire, when necessary, to permit making the test. After the fault has been isolated to a particular section or span, make a careful inspection of the wire in that section or span, if possible with the wire lowered, and when, if the fault is not found, cut out and replace the wire.

##### High Resistance Short Circuits

**4.05** High resistance short circuits often cannot be located by the tests described for low resistance short circuits. In this event it becomes necessary to obtain assistance by having the condition of the circuit observed at the testing equipment in the central office while one side of the line is opened at various points. When a disconnection at one point causes the fault to disappear and a disconnection at an adjacent point does not, the fault is located between the two points at which these tests were made. After the fault has been isolated in this manner to a particular section or span, make a careful inspection of the wire in that section or span, if possible with the wire lowered, and then, if the fault is not found, cut out and replace the wire.

#### Magneto or Local Battery Circuits—Locating Short Circuits in the Drop and Block Wire Plant

**4.06** To locate a short circuit in the drop or block wire plant in a magneto area it is usually advisable to first isolate the fault to a

particular portion of the drop or block wire. The following test can be used for this purpose. (See Figure 12.)

TESTS TO LOCATE SHORT CIRCUITS - MAGNETO LINES

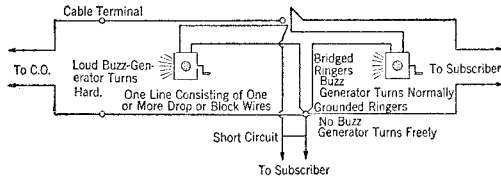


Fig. 12

Disconnect one side of the drop or block wire or wires (if more than one party is bridged at the point of test). Attach one clip of the test set to the end of the disconnected wire and connect the other clip to the other side of the line. If more than one wire was disconnected test each wire separately. With the switch of the test set in proper position for calling, spin the handle of the generator. If the handle of the generator turns harder than is normal on a clear line and the buzzer is louder than usual, the short is in the portion of the circuit under test and should be located by visual inspection or if necessary by further similar tests. Before reconnecting the wires transfer the test set clip from the end of the disconnected wire to the central office end of the circuit and repeat the test to be sure that this portion of the circuit is clear.

**5. CROSSES**

**5.01** Crosses in the drop and block wire plant result from the establishment of an electrical contact between one conductor of a drop or block wire and one conductor or binding post of another line. Troubles of this nature are therefore less common than grounds, opens or short circuits and are to a large extent limited to localities where two or more working block or drop wires are in close proximity.

**5.02** Common causes of crosses in drop and block wiring are:

- (a) Breakdown of the insulation on wires in ring runs on poles or buildings due to de-

terioration, abrasion on rings or injury from external sources.

- (b) Breakdown of insulation on wires in close proximity in building or pole runs due to deterioration, abrasion or other injury.

- (c) Improper dressing and connecting of wires at cable terminals so that wires or ends of wires touch adjacent binding posts of other lines.

**5.03** When the trouble to be located is a cross, the work is greatly facilitated if certain items of information have been obtained. These items are as follows:

- (a) The line number of each of the lines that are crossed together.
- (b) The cable number and pair number that each of the crossed lines takes.
- (c) Cable terminal locations — all terminals where drops terminate on either of the crossed lines.
- (d) Number of each pole on which drops of either line terminate (on other than cable lines), if available.

**Common Battery Circuits—Locating Crosses in the Drop and Block Wire Plant**

**5.04** In isolating a cross to a portion of the plant, such as to the drop or block wire plant or to a portion of a drop or block wire make the following test. (See Figure 13.)

TESTS TO LOCATE CROSSES

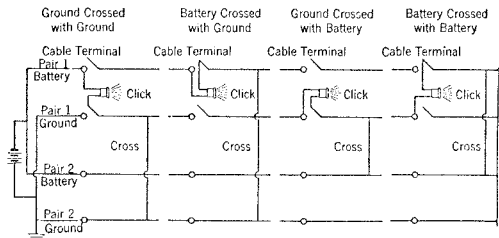


Fig. 13

- (a) Disconnect all wires of one of the crossed lines from the binding posts or bridging connectors, using care to so place the wires that they may be properly reconnected in their original position upon completion of the test.
- (b) Attach one clip of the test set to one of the pair of binding posts or bridging connectors from which the wires were disconnected and with the other clip touch in turn each of the wires just disconnected.
- (c) If no battery click is heard on the make and break of any of the contacts, transfer the clip on the binding post or bridging connector to the other binding post or bridging connector of the same pair and repeat the test.

If clicks are heard the wire causing the clicks when touched is crossed with another line and the cross is in the portion of the wire that is affected by the tests at this point. If no clicks are heard on either test the cross is not located in the portion of the circuit which is affected by the tests at this point. On party lines this test should be made at every point at which a drop or block wire is bridged to the circuit until the fault is isolated to the line of a particular party. After it has been determined that the fault locates on the station side of a cable terminal, there is still the possibility that the inside wiring of the station is crossed with another line. Therefore, to determine that the cross is located in the drop or block wire, the above test should be repeated at the protector or connecting block at the subscriber's premises.

**5.05** After the fault has been isolated in a drop or block wire, it usually can be found by carefully inspecting the wire throughout its entire length. If it cannot be found by inspection, it must be further isolated by repeating the tests at suitable points, if necessary cutting a conductor to permit making the test. If it is necessary to cut a conductor, repairs should be made on completion of the tests.

#### High Resistance Crosses

**5.06** When the cross is of high resistance so that the test set cannot successfully be used to locate the fault, request that the condition of the line be observed at the testing equipment in the central office while disconnections are made at various points in the circuit. The fault can in this manner be isolated to a particular portion

of the drop or block wire and can then be discovered by visual inspection. In areas where testing equipment suitable for this test is not available at the central office, the operator may be called and requested to talk or ring on one of the crossed lines while the test set is bridged to a suitable disconnected portion of the other circuit. If the ring or the operator's voice is heard in the test set the cross is in the portion of the circuit under observation and when by suitable repetition of this test the fault is isolated to a sufficiently small section of the drop or block wire it can be found by visual inspection.

#### Magneto or Local Battery Circuits—Locating Crosses in the Drop and Block Wire Plant

**5.07** When one of the crossed lines is unknown and no test deskman is on duty, the following test can be applied to identify the unknown line with which the known line is crossed. (See Figure 14.)

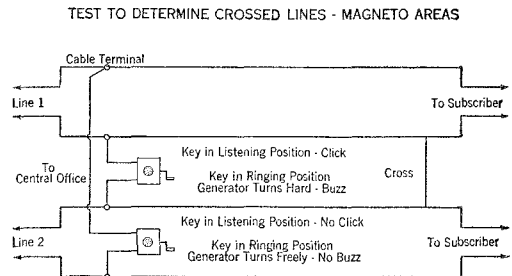


Fig. 14

At a cable terminal where drop or block wires of the known line terminate, or at the main frame, attach one clip of the magneto test set to one side of the known line. Place the test set switch in the listening position. While listening in the receiver, explore both sides of the other pairs with the free test set clip. If contact is made with the conductor which is crossed with the wire to which the other test clip is attached, a click will be heard in the receiver. If no click is heard after making contact with all the other wires, transfer the clip to the other side of the known line and repeat the same procedure. After the crossed wires have been indicated by the above test, this indication may be verified by ringing on the two wires. If the two wires are crossed the hand generator will turn hard as in the case of a short circuit.



5.08 To isolate a cross to a particular portion of a drop or block wire where it can usually be found by a visual inspection, make the following test at points where one or more drop or block wires are bridged to each of the lines affected. (See Figure 15.)

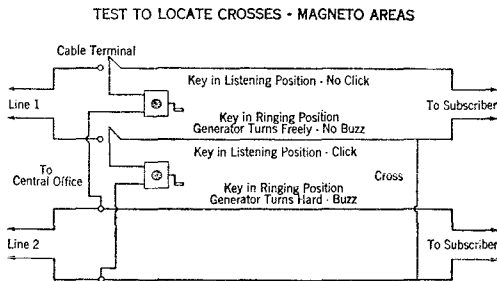


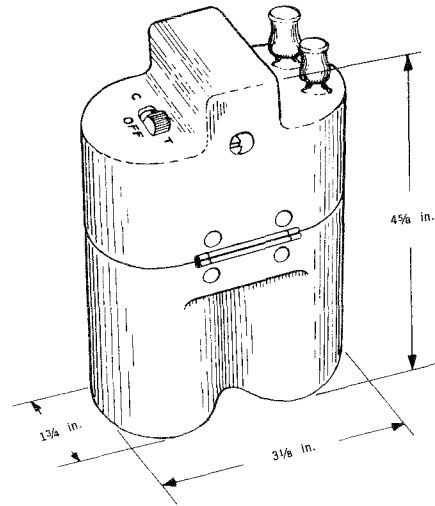
Fig. 15

Disconnect all drop or block wires that are bridged to one of the crossed lines at a cable terminal or other connecting point, so placing or identifying the wires that they may be properly reconnected in their original position. Connect one clip of the magneto test set to one of the disconnected conductors. With the test set switch in the listening position, touch with the other test clip first one and then the other wire of the other crossed line which was not disconnected. If no clicks are heard in the receiver of the test set upon the establishment of either of the above contacts, transfer the test clip to the other conductor of the disconnected pair and repeat the test. If no clicks are heard this time the portion of the circuit from the point of disconnection to the subscriber's station is clear. If a click is heard the cross is located in the wire tested, and an inspection of that wire should be made. If any other wires were disconnected they should be tested individually before they are reconnected. As outlined in paragraph 5.05, a check test can be made by ringing on the wires that the above test indicates are crossed. Further tests necessary to locate the fault may be made by testing as one pair the two wires that are crossed and proceeding as for a short circuit. In making any subsequent tests that are necessary, if the wires that are crossed can be identified by the tracer, it is not necessary to disconnect both wires. If it becomes necessary to make further tests at other than connecting points, it usually will be necessary to cut only one of the wires that is known to be crossed.

## 6. 81A TEST SET

6.01 The 81A Test Set, as shown below, consists of a buzzer, capacitor and switch which are contained in a case made of insulating material. The case is equipped with two spring-type binding posts to which W2AK Test Set Cords or the wire itself may be connected. Space is provided within the case for two KS14711 (standard flashlight) dry cells in series which are required for the operation of the test set.

6.02 The switch has 3 positions: OFF, C for dc continuity test, and T which furnishes buzzer tone.



## 7. USE OF 81A TEST SET

7.01 The 81A test set may be used on non-working inside wiring cable and drop, block, and inside wire to trace non-working conductor pairs which cannot be readily traced by sight or to make continuity tests on non-working conductor pairs.

7.02 The 81A test set should *not* be used on working lines because the buzzer tone will interfere with the customer's use of these lines and may result in a customer trouble report.

**7.03** When tracing conductors or testing for open conductors it is necessary to use a hand test set in conjunction with the 81A test set. To detect shorted conductors or low resistance grounded conductors the 81A test set alone is sufficient.

#### **8. TESTING FOR SHORTED (Crossed, Shunted) CONDUCTORS**

**8.01** Connect 81A test set across the pair of non-working conductors to be tested, with the switch in the OFF position.

**8.02** Push switch to C position

- If the buzzer does not buzz, the pair is not shorted.
- If the buzzer buzzes, there is a short across the pair.

#### **9. TESTING FOR OPEN CONDUCTORS**

**9.01** After testing for a short circuit, push switch to the T position to start buzzer.

**9.02** Assuming the location of both ends of the pair is known, go to one end with a hand test set and connect it across the pair.

- If the buzzer is heard, the pair is not open.
- If the buzzer is not heard, the pair is open on one side or both.

**9.03** Each side can be checked if a spare conductor (known to be good), is available between the two points, or if there is a good ground connection available at both ends, by connecting the 81A test set between one conductor

and the spare or ground at one location and connecting the hand test set at the other location between the spare or ground, as the case may be, and the conductor being tested.

- The buzzer tone indicates that side is not open.
- No buzzer tone is an indication that the side is open.

#### **10. TESTING FOR LOW RESISTANCE GROUNDED CONDUCTORS**

**10.01** At a location where there is a good ground, connect one side of the 81A test set to the ground connection and the other side to one conductor of the wire being tested.

**10.02** Push switch to C position.

- If the buzzer is heard, the conductor is grounded.
- If the buzzer is not heard, the conductor does not have a low resistance ground.

**10.03** Repeat this operation on the other conductor of the wire involved.

**10.04** The consideration involved in testing for high resistance grounds is covered in part 2 of this section.

#### **11. TRACING NON-WORKING CONDUCTORS**

**11.01** Connect the 81A test set across the pair of the non-working conductors to be traced and test to be sure there is not a short circuit. Switch to the T position to start buzzer and go to the location at which it is desired to identify the wire. Using a hand test set, bridge it across each pair of wires until tone is heard. If tone cannot be heard on any pair, either the pair does not appear at that particular point or one or both sides of the pair is open.



## AUXILIARY SIGNALS

### INSTALLATION AND MAINTENANCE

#### 1. INTRODUCTION

**1.01** This section covers installation and maintenance of various auxiliary signals which may be associated with telephone stations to meet special requirements for loud or distinctive tone signals.

**1.02** This section is reissued to update information.

#### 2. GENERAL

**2.01** Prior to installation, a definite agreement covering the provision of any necessary power wiring must be made with the customer.

**2.02** Any telephone station using auxiliary signals (except a PBX extension) must be equipped with an audible signal (ringer or loud-ringing bell) connected to the line at all times to ensure a ringing signal should commercial power fail.

**2.03** Relays which operate on telephone ringing current have two sensitivity terminals. Use the high sensitivity terminal on manual service or where loop resistance would cause the relay operation to be uncertain. Use the low sensitivity terminal in dial area.

**2.04** Where a weatherproof power outlet box is involved, a ground-type outlet box, such as NS-16301, List 18 will be furnished by the telephone company. The outlet box should be installed by the customer's electrical contractor, who will be advised that this fixture shall be grounded.

**2.05** When planning the installation, take care to:

- Place signal where sound will be distributed as evenly as possible over the area to be served
- Use surfaces where signal can be securely fastened
- Locate where it will not be damaged or made inaccessible by objects piled near or against it
- Place signal in location (open stairs, moving machinery, etc) that is not hazardous to workmen.

**THINK** *Under no circumstances should the cord provided for commercial power be passed through a hole in a wall or be fastened to a wall.*

#### 3. INSTALLATION

**3.01** Equipment mounted outdoors should be securely mounted with rustproof fasteners such as galvanized screws or bolts.

**3.02** The armature on relays associated with auxiliary signals restores to normal (open contacts) by gravity. Always mount signal on a vertical surface. The relays must be in the horizontal position as shown in Fig. 6.

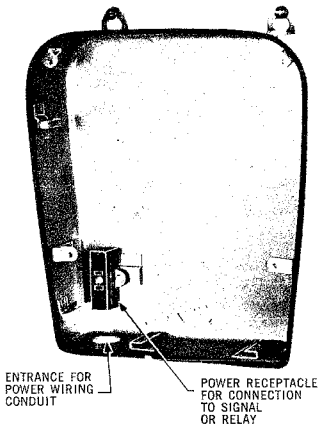
**3.03** To avoid inductive interference, use a full cable pair for each signal circuit when signalling circuits and talking circuits are in the same cable. When no talking circuits are involved, low-voltage signal circuits may use half of a cable pair or inside wire.

**NS-16301 Signal**

**3.04** The use of backboards is not necessary for these types of signals. The backbox has two slotted holes and one regular hole for mounting purposes.

**3.05** Where a conduit installation is involved, the back box should be installed so that the customer may have the commercial power connected (see Fig. 1). Install signal after power connection has been made.

**Note:** Remove the power cord and bushing.



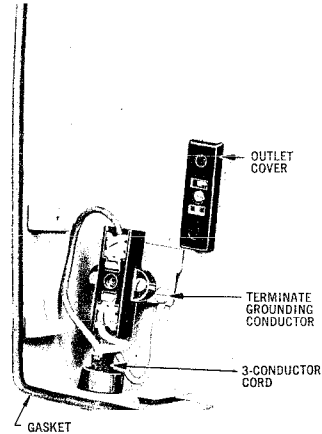
**Fig. 1 — NS-16301-Type Back Box, Conduit Installation**

**3.06** Power connection can be made on the power receptacle in the back box, by the customer's electrical contractor, by removing the screw located in the center of the receptacle cover (see Fig. 2). The terminals for terminating the power wiring are located directly under this cover.

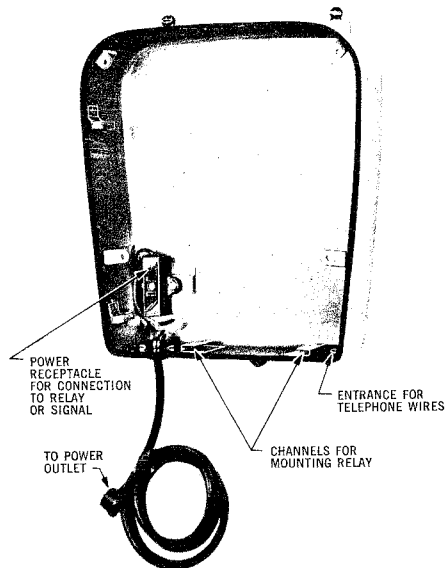
**3.07** When a 3-conductor cord is used on an indoor or outdoor installation, the green wire, which is ground, should be terminated under the screw located to the right of the power receptacle (see Fig. 2).

**3.08** An entrance hole for the telephone wires (control voltages) is located in the base of each back box (see Fig. 3). For dual potential signals, the telephone wire is connected directly

to the relay. The workman must connect to the proper terminals on the relay to operate the relay from the control voltage.



**Fig. 2 — Power Cord Termination**



**Fig. 3 — NS-16301-Type Back Box, Using Flexible Cordage Installation**

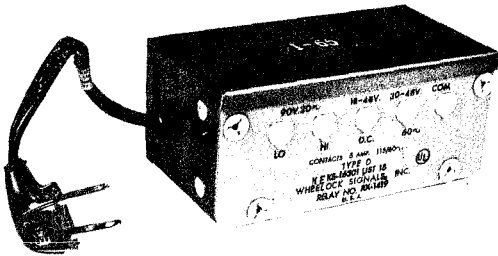


Fig. 4 - NS-16301, List 15 Relay

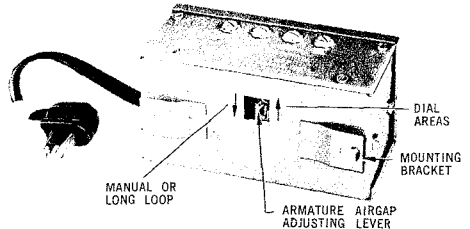


Fig. 5 - NS-16301, List 7 Relay  
(Wheellock Signals Co)

3.09 The NS-16301, List 15 Relay is provided with two sensitivity terminals designated "HI" and "LO". The superseded NS-16301, List 7, which may be substituted, had an armature airgap adjustment located on the bottom. (See Fig. 5.)

3.10 The armature airgap adjustment on the NS-16301, List 7 Relay corresponds to the two sensitivity terminals of the NS-16301, List 15 Relay.

3.11 Each back box is equipped with two sockets which engage with two pins of each front cover to form a hinge (see Fig. 6). The signal fastens to the back box with four machine screws which are furnished with the gridded cover. Be sure that the gasket on the back box is in place. For outdoor use, the rain hood mounts on the cover with three machine screws.

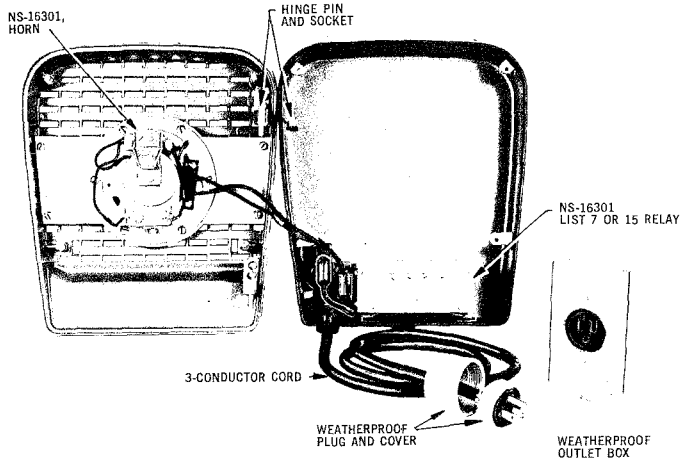


Fig. 6 - Complete Assembly, Outdoor Dual Potential, Horn

## 4. MAINTENANCE

**THINK** → Before performing any work on equipment connected to commercial power, the power supply circuit shall be de-energized. The customer shall arrange for power disconnection and reconnection on power circuits other than plug and outlet.

## NS-16301 Signal

4.01 The vibrating bell is provided with a volume adjustment. The volume is controlled by a screw adjustment on the back of the bell resonator. The direction of adjustment is stamped near the adjusting screw.

4.02 The volume of the single stroke bell may be adjusted by means of a cotter key, which is the backstop for the plunger (see Fig. 8). The signal is shipped with the key inserted through the lowest of the three holes in the sleeve that contains the plunger, thereby providing maximum volume. To decrease volume, move cotter key to intermediate or top hole in the sleeve. This adjustment was not provided on some bells of initial manufacture.

4.03 If a signal becomes defective, the appropriate list number should be ordered. (See the Catalogue of Supplies for ordering information.)

4.04 The List 7 and 15 Relays should meet the following requirements:

- The armature should not chatter when the relay is operated with the specified voltage
- The armature should not bind or stick; gauge by feel
- Minimum contact pressure, 6 grams, measured with relay operated either electrically or manually; use 70H Gauge
- The contacts should make almost simultaneously; gauge by eye

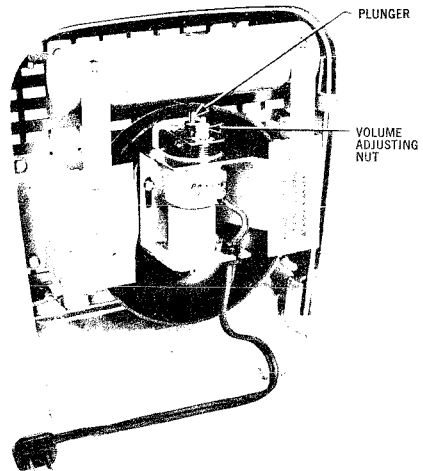


Fig. 7 — NS-16301 - Type Bell, Vibrating

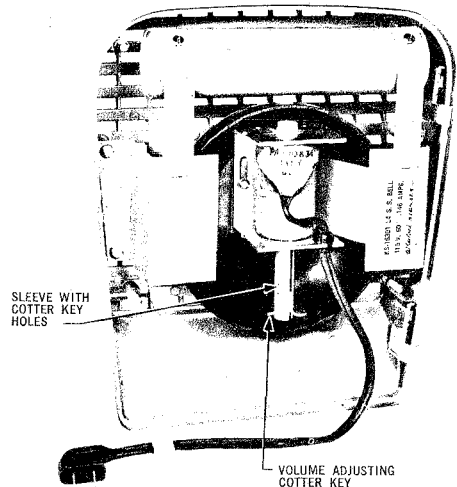


Fig. 8 — NS-16301, Type Bell, Single Stroke

- The armature and pole piece should be free of dirt or metal filings; gauge by eye. Clean with 1, 2-inch relay cleaning strips or equivalent
- List 7 or 15 Relays used as a ringing bridge should not chatter on dial pulsing sufficiently to cause the contracts to make Check position of H or L sensitivity adjustment, i.e., H for long loop or L for dial area. If relay meets all requirements but chatters on dial pulsing, replace in accordance with local instructions.

### Explosive Atmosphere Signals

#### 5. INSTALLATION

5.01 The NS-8547, List 1 and 3 Bells and the NS-16763, List 4 Power Relay Set are intended for use in explosive atmosphere areas, Class 1B, C, D and 2F, G respectively.

**Note:** The general information and safety requirements described in Section 502-415-100, entitled "Telephone Sets - Explosive Atmospheres - General Requirements", shall be adhered to when installing or performing maintenance on this equipment.

5.02 No maintenance should be performed on these components. Direct replacement is recommended. Follow the general safety requirements described in the section listed above before working on this equipment.

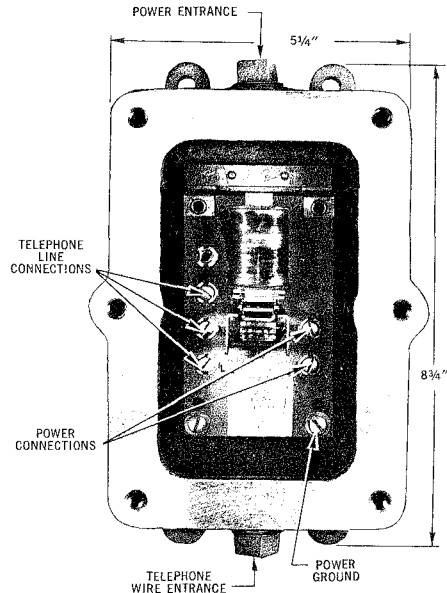
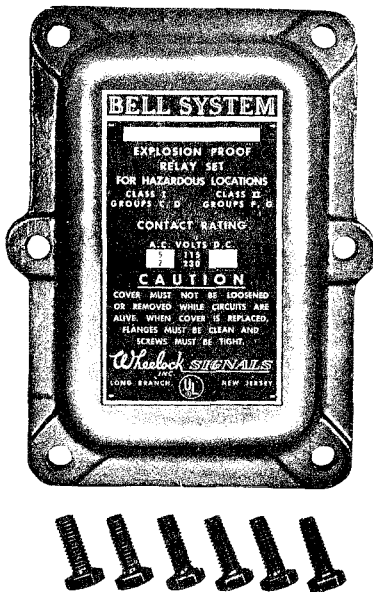


Fig. 9 - NS-16763 Relay Set





## AUXILIARY SIGNALS CONNECTIONS

### 1. GENERAL

1.01 Certain auxiliary signals and power relay sets for use on telephone lines are equipped with a 0.5- or 0.45-uf capacitor in series with a relay which operates on telephone ringing current. The relay and capacitor constitute a high-impedance ringing bridge which is subject to provisions of appropriate section covering ringing-bridge limitations.

1.02 The total number of auxiliary signals which may be connected to a power relay set is limited by the individual signal-operating currents, the sum of which cannot exceed current-carrying capacity of relay contacts. Individual

signal-operating currents and current-carrying capacity of power-relay set contacts are covered in Tables A and B of Section 463-120-100, entitled Power Relay Sets — Identification, Installation, and Maintenance.

1.03 Marginal arrows have been used to indicate changes.

### 2. CONNECTIONS KS-16301 SIGNALS

2.01 Connections for relays and signals are shown in Fig. 1. Also shown are the voltage values and terminal locations on the List 7 or 15 Relay.

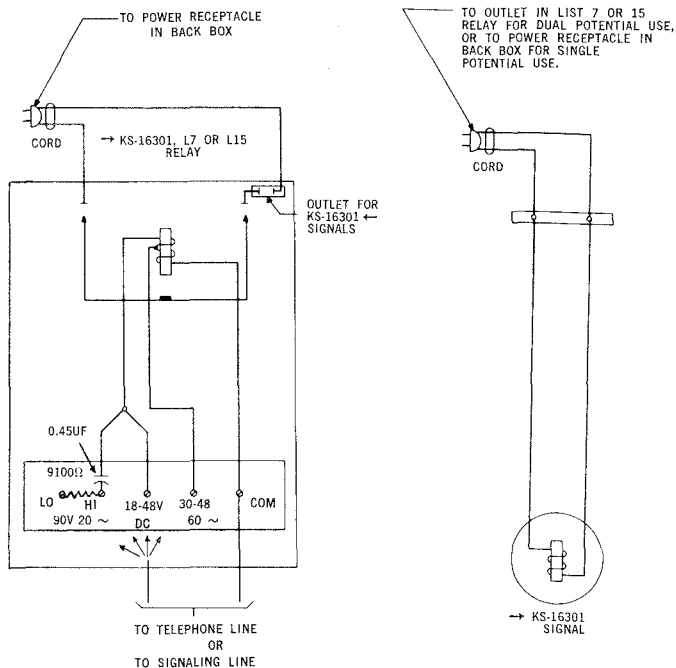


Fig. 1 — KS-16301 Signal Connections

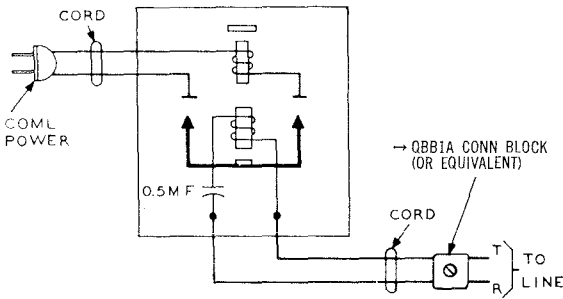


Fig. 2 - Typical Relay-equipped Signal Connections

KS-8000 Series signals (Relay equipped) No longer available. Shown for maintenance purposes only.

2.02 Connections for typical relay-equipped signals are shown in Fig. 2.

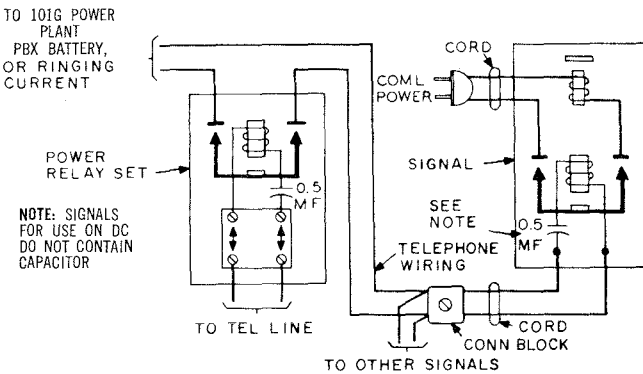


Fig. 3 - Multiple Signal Connections

2.03 Several signals may be connected as shown in Fig. 3. This has the advantage of only one ringing bridge on the telephone line for several auxiliary signals. Special commercial power wiring is not needed between the relay set and the signals.

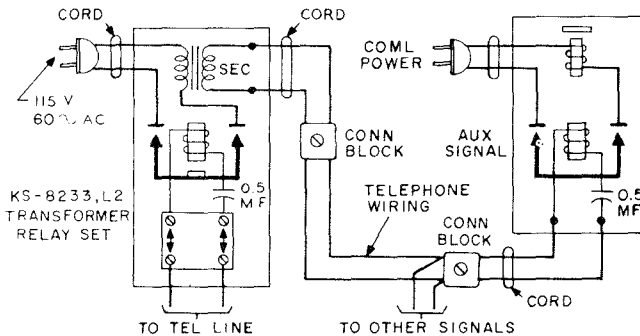
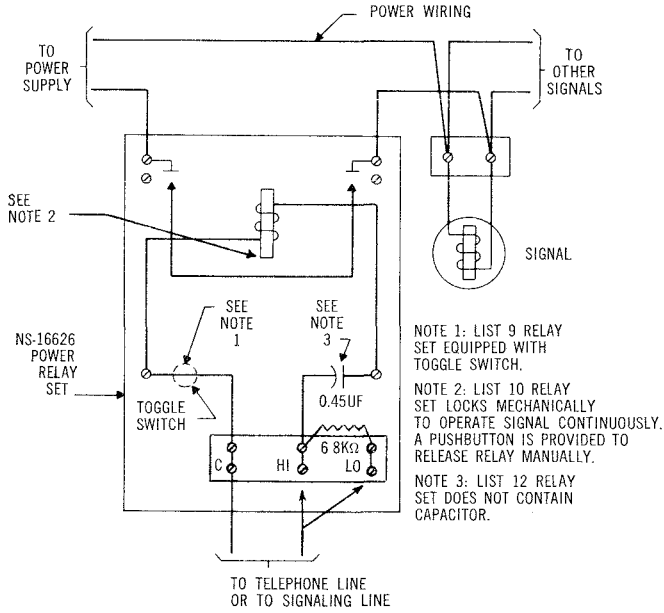


Fig. 4 - KS-8233, List 2 Transformer Relay Set Connections

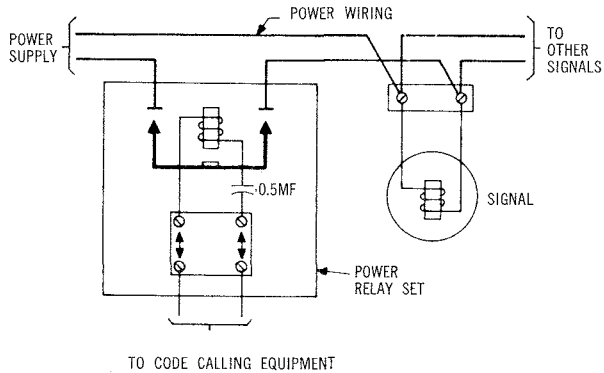
2.04 The KS-8233, List 2 Transformer Relay Set has been used to connect several signals to one telephone line, as shown in Fig. 4, and may be encountered in some existing installations.

**KS-8000 Series or Customer Owned Signals (Without Relay)**

2.05 Connections for signals which do not have a self-contained power relay are shown in Figs. 5, 6 and 7. These signals require commercial power wiring between the relay set and the signal.



**Fig. 5 — NS-16626, List 8 Power Relay Set Connections**

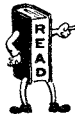


**Fig. 6 — KS.16527 or Equivalent, Power Relay Set Connections**

**Explosive Atmosphere Signals**

- 2.06 The KS-16763, List 4 Power Relay Set is intended for use in explosive atmosphere areas. Follow general installation and safety requirements described in Section 502-415-100 before working on this equipment.
- 2.07 The KS-16763, List 4 Relay has two sensitivity terminals. The "HI" sensitivity terminal is for use on manual ringing lines or where the loop resistance would cause the relay operation to be uncertain. The "LO" sensitivity terminal

is for use on dial operated telephone lines or whenever relay is slow to release due to stray pickup.



*To ensure the reliable release of power relays operated from ringing current, it is advisable to cut-off the live side of the generator supply and to ground the return side locally, especially when using local power plant. (See Fig. 8).*

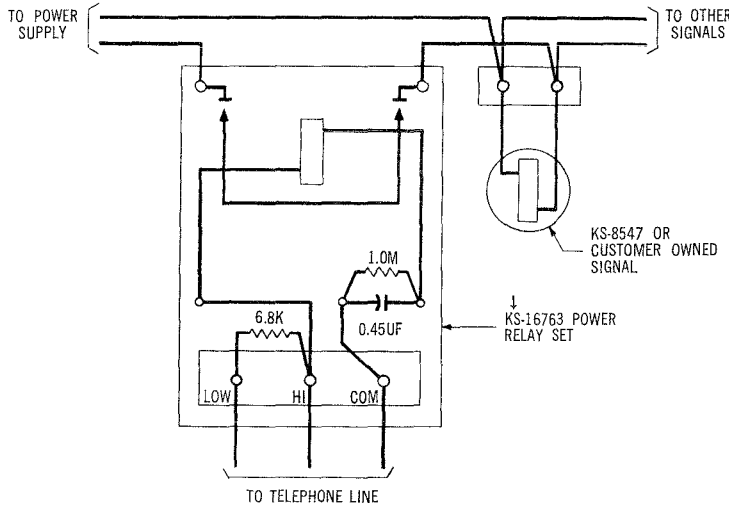


Fig. 7 — KS-16763, List 4 Power Relay Set Connections

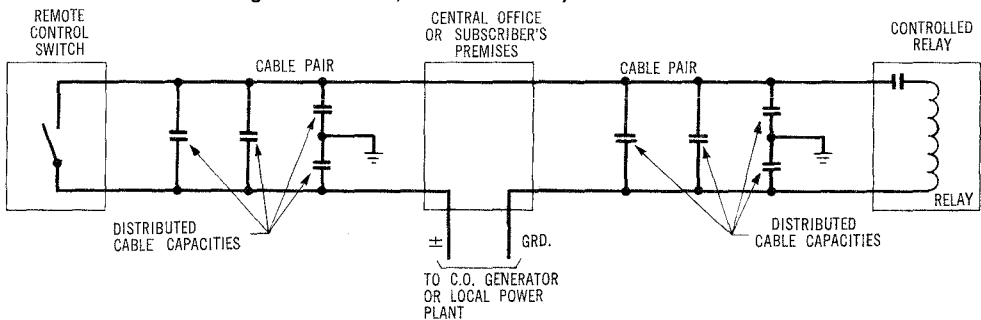
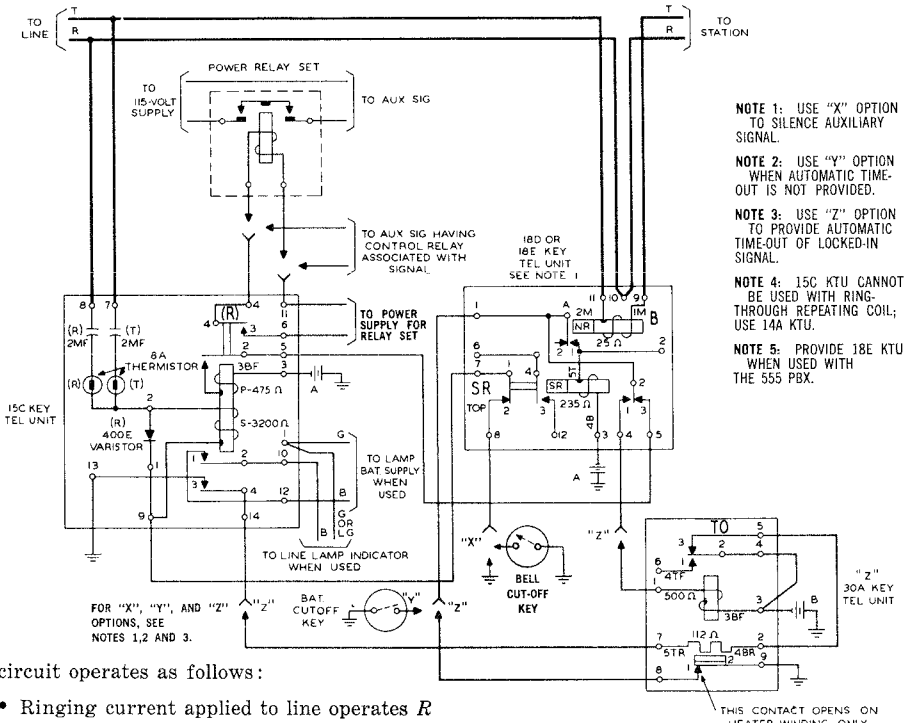


Fig. 8 — Typical Remote Control Relay Connections

**Note:** If live side of generator supply is connected directly to the relay and the ground return is opened at the remote control point, the distributed cable capacitances may be enough to keep relay operated.



The circuit operates as follows:

- Ringing current applied to line operates *R* Relay through its secondary winding, through top Contacts 1 and 2 of *SR* Relay-to-ground.
- *R* Relay locks operated by battery through its primary winding, through its own top Contacts 1 and 2, through bottom Contacts 3 and 2 of *SR* Relay, through bottom Contacts 1 and 2 of *TO* Relay (*Z* Wiring) to ground, or to switch-to-ground (*Y* Wiring).
- *R* Relay operated completes circuit through its own top Contacts 3 and 4 to operate auxiliary relay or signal.
- Bottom Contacts 1 and 2 of *R* Relay may be used to operate a line lamp indicator.
- When call is answered, *B* Relay operates by central office or PBX battery through station.
- *SR* Relay operates by battery through its winding, through Contacts of *B* Relay (operated), and through bottom Contacts 1 and 2 of *TO* Relay-to-ground (*Z* Wiring).
- Operation of *SR* Relay opens locking circuit of *R* Relay which releases.
- Circuits to auxiliary signal and line lamps open when *R* Relay releases.
- Unanswered calls are handled by a time-out feature. When *R* Relay operates, ground is connected through bottom Contacts 3 and 4, through 112-ohm heater winding of *TO* Relay (*Z* Wiring), and through top Contacts 3 and 2 of *TO* Relay-to-battery. After approximately 30 seconds, thermally operated bottom Contacts 1 and 2 of *TO* Relay will open. This opens locking circuit of *R* Relay, and circuit restores to normal.
- If call is answered, *SR* Relay operates as previously described. Circuit is completed from battery through *TO* Relay, through bottom Contacts 1 and 2 of *SR* Relay (operated), and through bottom Contacts 1 and 2 of *TO* Relay-to-Ground. This opens heater winding circuit of *TO* Relay.

Fig. 9 — Connections and Circuit Operation for Continuous Auxiliary Signals



## VOICE STATION COUPLERS

### QCS TYPE

#### DESCRIPTION, INSTALLATION, MAINTENANCE & TESTS

	CONTENTS	PAGE
1.	GENERAL . . . . .	317
2.	DESCRIPTION . . . . .	318
	A. Physical Description QCS1A . . . . .	318
	B. Physical Description QCS2B . . . . .	319
	C. Functional Description . . . . .	322
	Calling Procedure . . . . .	322
	Answering an Incoming Call . . . . .	322
3.	INSTALLATION AND CONNECTIONS . . . . .	322
4.	MAINTENANCE . . . . .	328
5.	TESTS . . . . .	328

**1. GENERAL**

**1.01** This section provides information required for installing and maintaining the Voice Station Coupler QCS1A and QCS2B. These couplers were previously coded QCT.

**1.02** This section is revised to update information and include supplement and addendum.

**1.03** The voice station coupler provides a means whereby customer provided telephone answering machines and alarm sending machines may be connected to the switched telecommunications network.

**1.04** The voice station coupler is designed to provide the following:

- Isolation of customer equipment for the protection of the telephone plant and personnel.

- Detection of incoming ringing signals.
- Off-hook control which allows customer equipment to answer incoming calls automatically and to dial pulse for call originations.
- Exclude an associated telephone set.
- Two way transmission path.
- Internal ringing supply 65 to 95 volt, 60 Hz.
- Option to provide for 20 Hz ringing.
- Off-hook indicator to provide customer with voice station coupler status.
- "A" lead control for operation with key telephone equipment.
- Option to provide 24 V DC reserve battery by customer.
- Peak signal limiting, to protect the telephone network from high signal levels from the customer equipment.
- Disconnection under control of the central office if the customer's equipment fails to disconnect (QCS2B only).
- Limits voltage applied to customer equipment under line surge conditions to 30V peak.
- Provides test key for remote testing of the QCS2B unit only.

**1.05** An associated telephone set may be operated in the conventional manner when the voice station coupler is not in operation.



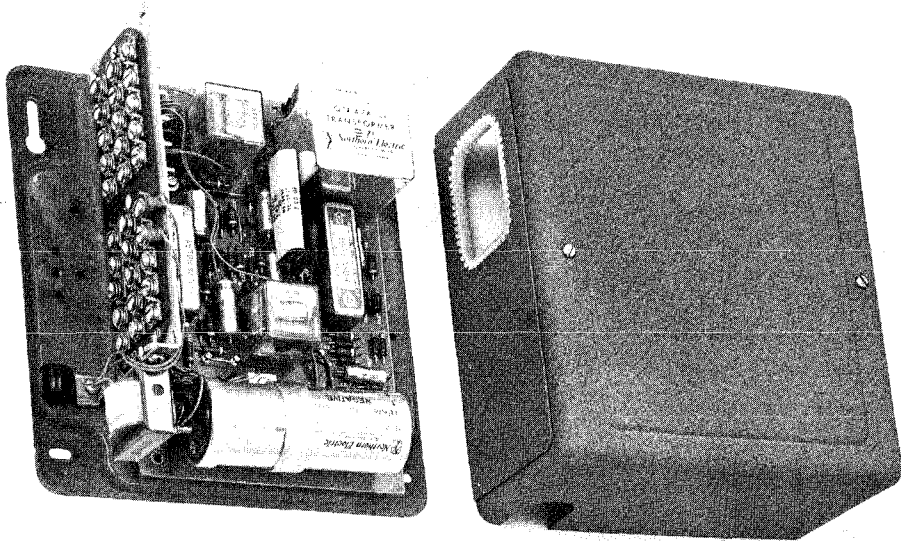


Fig. 1 — QCS1A Voice Station Coupler

1.06 An external transformer (type 2012B) is required to supply power for each station coupler.

1.07 ORDERING INFORMATION  
Coupler Voice Station QCS2B  
ASSOCIATED APPARATUS  
Transformer 2012B

2. DESCRIPTION

2.01 The circuitry for the coupler is mounted on a single printed circuit board.

2.02 The major components of the voice station coupler consist of the ring detector, off-hook circuitry, peak signal limiter, ringing voltage transformer, rectifier and filter, remote disconnect circuitry and dial pulse repeating.

2.03 A functional schematic of these components is shown in Fig. 3.

A. Physical Description QCS1A

2.04 The voice station coupler QCS1A (Fig. 1) is a wall mounted unit measuring  $6\frac{3}{4}$  inches wide,  $6\frac{5}{8}$  inches high and  $3\frac{3}{8}$  inches deep. The coupler weighs approximately 3 pounds and is enclosed in a metal apparatus box. Two key hole slots at the top and two screw holes at the bottom are provided on the base for mounting the unit on a wall or other vertical surface.

2.05 The terminal block which has 3 rows of 10 terminals is mounted on the left hand side of the apparatus box.

2.06 The top half of the block which has 15 terminals is for connecting the customer's equipment. See Table A for the designation of each lead at the interface. These terminals are accessible to the customer through an opening in the left hand side of the apparatus box cover.

2.07 The bottom half of the block which has 15 terminals is for connecting the telephone line and associated apparatus to the coupler. See Table B for lead designations.

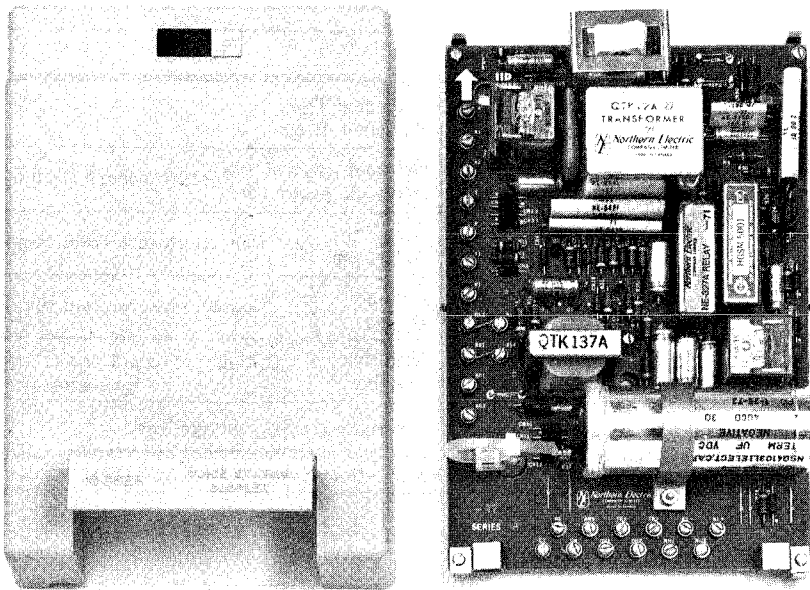


Fig. 2 — QCS2B Voice Station Coupler

### B. Physical Description QCS2B

**2.08** The coupler QCS2B (Fig. 2) is a wall mounted unit measuring 8 inches wide, 9 inches high and 2½ inches deep. The coupler weighs approximately 3 pounds and is enclosed in a plastic moulded box. Two key hole slots at the top and one key hole slot at the bottom are provided on the base for mounting the unit on a wall or other vertical surface.

**2.09** The QCS2B couplers are similar to the QCS1A coupler in circuitry and compatible with the exception of the remote test key, located at the top of the couplers.

**2.10** The test circuit consists of a non-locking test key. When the test key is operated it removes the transmission path from the customer

equipment and allows the verification of the ringing and on/off hook control circuitry.



ACCIDENTAL OR INTENTIONAL OPERATION OF THE "TEST" KEY DURING TRANSMISSION WILL INTERRUPT AND RELEASE THE LINE.

**2.11** The interface terminal block for the connection of the customer provided equipment is located at the bottom of the coupler. The terminal designations for the customer are shown in Table A.

**2.12** The terminal block for the connection of the telephone company equipment is located at the left side of the printed circuit board. The functional schematic is shown in Fig. 3 (Table B).

TABLE A

Terminal Number QCS1A Only	Terminal Designations QCS1A and QCS2B	Function
14 15	CT CR	Customer Tip Customer Ring
13 12	OH1 OH2	Off-hook control } Contact closure from customer Off-hook ground }
2 3	RU1 RU2	Ring } Contact closure from coupler Indication }
1 11	TR1 TR2	Coupler } Contact closure from coupler Status }
4 5	B2- B1+	Negative } Optional external power supplied Positive } by customer
25 22	RS ANS	Alternate ringing voltage lead. Optional customer control of transfer between auxiliary telephone set and CPE.
21 23 24	SPARE SPARE SPARE	

TABLE B

Terminal Number QCS1A Only	Terminal Designations QCS1A and QCS2B	Function
6 16	T R	Telephone line to CO, PBX or Key equipment
7 17	T1 R1	Connections to associated telephone set
8 18 28	A A1 A2	"A" Lead control contacts for associated key telephone equipment
19 29	AC1 AC2	18 volt AC power supply from external trans- former
26 27	RS1 RS2	Ringing input (60 Hz internal or 20 Hz external)
9 10 20 30	SPARE SPARE SPARE SPARE	

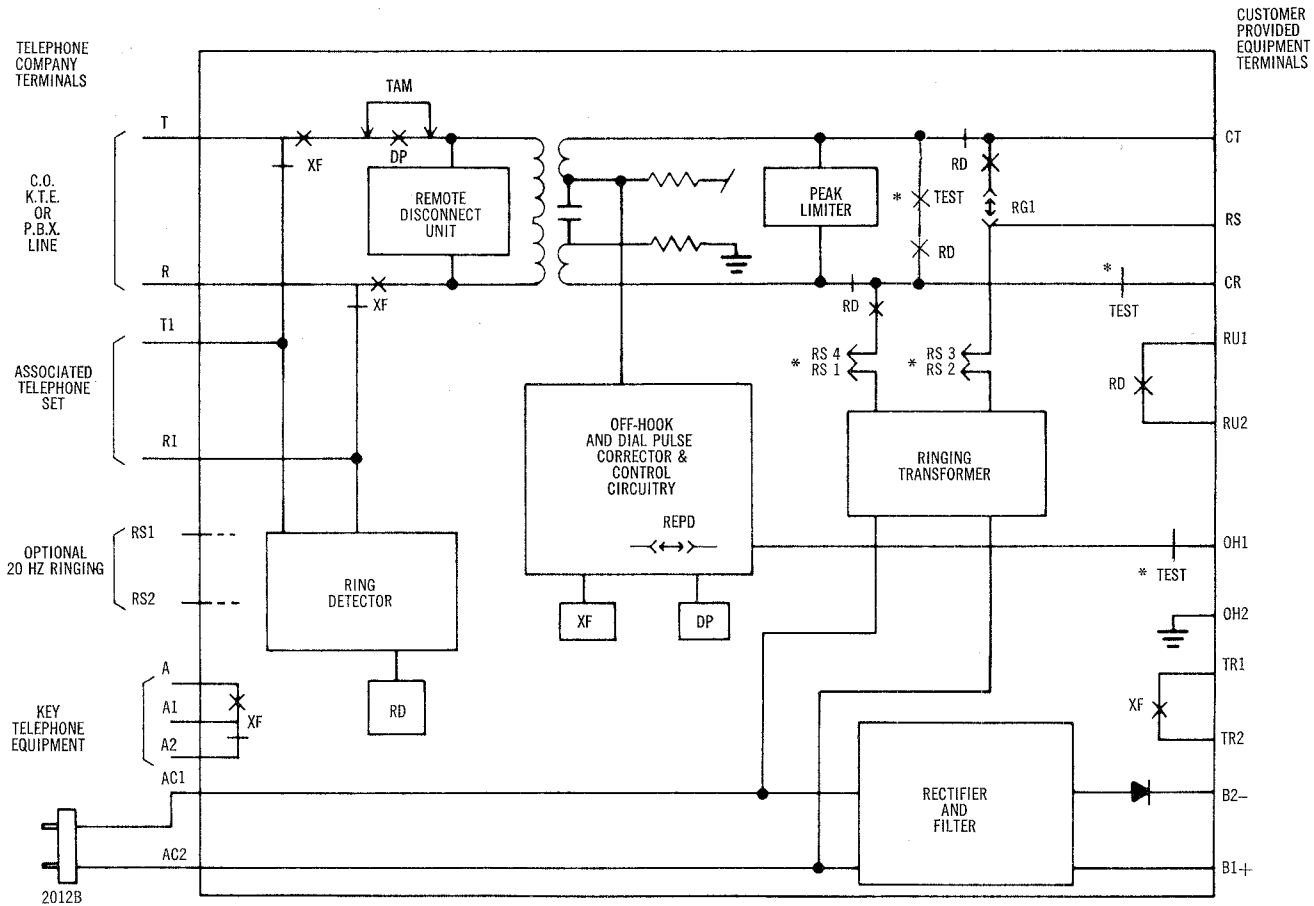


Fig. 3 — Functional Schematic of Voice Station Coupler

\* QCS 2B UNIT ONLY

**C. Functional Description**

**2.13 Calling Procedure:** To initiate a call, the customer's equipment provides a closure between the CT & CR leads. This provides a circuit for the XF relay to operate which disconnects the auxiliary terminals T1 and R1 from T and R, thereby disabling the associated telephone set. The XF relay contacts short circuits leads TR1 and TR2 and A and A1 which are used to provide other functions of the coupler. (Option K) Customer dials on CT and CR leads. (Option L) Customer dials on OH1 and OH2 leads. Either option will operate the DP relay in the control circuit, providing a closure to the central office. The L relay (remote disconnect circuit) operates from central office battery to provide a hold circuit for the XF relay (QCS2B only). The DP relay follows the pulses of the dial and merely repeats the dial pulses over its contacts out on the telephone line.

**2.14 Answering an Incoming Call:** The ring detector is activated (Fig. 3) when 20 Hz ringing is present on the line indicating an incoming call. The RD relay, part of the ring detector operates and releases in response to the ringing cycle (i.e., 2 seconds operated — 4 seconds released): The operation of relay RD causes a contact closure between terminals RU1 and RU2. It also causes 20 Hz or 60 Hz ringing voltage from the ringing transformer to be applied between terminals CR and CT or between terminals CR and RS, depending on whether or not the RGI strap is in place (Option G).

**Note:** QCS1A Coupler introduces a 400 millisecond delay in the start of the ringing supply to customer equipment.

The customer's equipment should detect one of these ringing indications and must either terminate CT and CR with a resistive termination of 600 ohms or less (Option K) or the customer's equipment must also terminate OH1 and OH2 with a resistive termination of less than 100Ω (Option L) to trip the ringing and answer the call.

If the customer's equipment places a 600 ohm or less termination between terminals CT and CR during the ringing silent interval, the "Ring Trip Circuit" will operate the "Off-Hook Control" which will operate relay XF.

A termination of 100 ohms or less placed across terminals OH1 and OH2 causes the Off-Hook Circuitry to operate, (during the ringing or silent interval) which operates the relay XF. The contacts of the XF relay will transfer the line from the associated telephone set to the voice station coupler and close the loop to trip ringing. The XF relay contacts also signal the associated key equipment, if provided, over terminals A, A1 or A2 and the customer's equipment over terminals TR1 and TR2. When (Option D) is specified the coupler will not operate to customer equipment seizure during the ringing interval. The coupler will recognize such condition only in the silent interval.

The calling party is now connected through to the customer equipment by the CT and CR terminals.

When the call is completed the customer's equipment will remove the termination on CT and CR or on OH1 and OH2 leads. This causes the Off-Hook Control Circuitry to release relay XF which disconnects the coupler from the line.

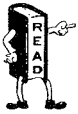
**2.15** The Peak Signal Limiter limits the voice signals from the customer equipment to +3 dBm (measured across terminals CT and CR).

**2.16** The voice station coupler is powered by the Rectifier and Filter which operates from a 2012B transformer.

**2.17** The Remote Disconnect Unit monitors the loop current during a call. If the loop current is disconnected for more than 3 seconds the Remote Disconnect Unit will disconnect the coupler (QCS2B only) even though the customer's equipment is applying an Off-Hook termination to terminals CT and CR or OH1 and OH2. The circuit will restore to normal when the termination is removed from the CT-CR or OH1-OH2 leads.

**3. INSTALLATION AND CONNECTIONS**

**3.01** The voice station coupler may be used with various types of central office lines, key telephone systems, and PBX lines that provide access to the switched network.



ALL INSTALLATION CONNECTIONS AND TESTS MUST BE PERFORMED PRIOR TO THE CUSTOMER MAKING ANY CONNECTIONS TO THE COUPLER.

**3.02** The installation of the coupler should comply with general practices to ensure an orderly station arrangement.

**3.03** The coupler is provided only to protect and isolate Telephone Company facilities from C.P.E. They should not provide supervision features not required to maintain isolation and protection. Telephone Company facilities should normally terminate on the "in" side of a coupler and the customer's equipment should normally terminate on the "out" side. Telco couplers should appear in the circuit at the immediate point of interconnection so that trouble sectionalization is possible.



DO NOT INSTALL NEAR HAZARDOUS LOCATIONS, MOISTURE, OR EXCESSIVE HEAT.

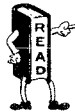
**3.04** The coupler must be mounted vertically on a surface not subject to vibration. Provide space at the left of the coupler (QCS1A) for the customer to have access to the terminal strip. If a backboard is required the KS5796L7 backboard is recommended.

**3.05** Locate the coupler within 5 feet of the associated telephone set.

**3.06** Locate the coupler approximately 6 feet from the 105-125V 50-60 Hz electrical outlet, provided by the customer.

**3.07** Install the coupler on the wall or backboard as follows:

- (1) Carefully remove cover of the coupler.
- (2) Position the coupler base pan vertically against the wall with the key hole slots narrow end at the top.



THE MERCURY RELAY IN THE COUPLER WILL ONLY FUNCTION PROPERLY MOUNTED IN THE UP-RIGHT POSITION.

(3) Secure the base with 4 screws. SEE TABLE C FOR FASTENERS.

**3.08** Location of the QCS1A voice station coupler terminals are shown in Fig. 4.

**3.09** Connect the 0 and 1 button key type telephone sets and call directors with a voice station coupler as shown in Fig. 5.

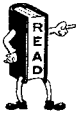
**3.10** On key systems where 6 button key type telephones are used and it is not practical to run a separate cable for the voice station coupler, install a 565 HQF key telephone set and connect as shown in Fig. 6.

**3.11** There are various option strapping arrangements within the voice station coupler (See Table D). These straps are soldered between terminals on the circuit board.

TABLE C  
FASTENERS FOR MOUNTING COUPLER

Hardwood	Softwood	Masonry	Plaster	Hollow Tiles
3/4" No. 8 Woodscrew	1" No. 8 Woodscrew	1" No. 8 Woodscrew No. 10 Plastic Anchor.	2" No. 8 Woodscrew No. 10 Plastic Anchor.	1/8 x 4" Toggle Bolts

SECTION 463-233-900CA



THE OPTIONS WILL BE SPECIFIED ON THE SERVICE ORDER. THERE MUST BE A MINIMUM OF THREE OR A MAXIMUM OF FOUR OPTIONS. IF NOT, REFER SERVICE ORDER TO SUPERVISOR WHO WILL CONTACT THE MARKETING DEPARTMENT.

- 3.12 Connect the 2012B transformer to AC1 and AC2 terminals as shown in Fig. 5.
- 3.13 Perform the operational tests shown in Part 5.
- 3.14 Place the cover on the voice station coupler.
- 3.15 Inform the customer of the following:

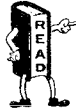
- (a) The maximum permissible signal power output from the customer's equipment must not exceed  $-8$  dBm. The output level of the customer equipment is the power measured at the customers interface into a 600 ohm resistive load.
- (b) The customer can furnish a reserve power supply of  $-18V$  to  $-26V$  DC connected to terminals B1- and B2+. This will provide power for outgoing calls only. No ringing voltage will be provided with this option. The customer should detect incoming calls using the contact closure between RD1 and RD2.

- (c) The customer interface connections are made on terminal strips located as follows:

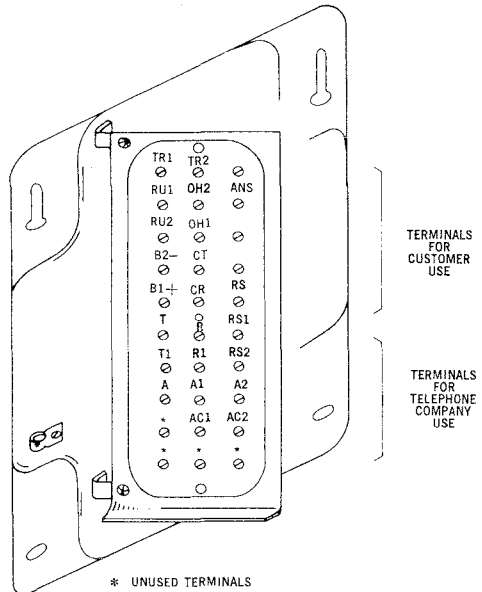
- QCS1A to the top left hand side opening of the coupler cover.

- QCS2B under a protective "flip-up" cover at the bottom of the coupler.

- 3.16 Options for the QCS Couplers are shown in Table D.



THE CUSTOMER SHOULD BE ADVISED TO REMOVE THE TRANSFORMER FROM THE OUTLET WHILE CONNECTING HIS EQUIPMENT.



NOTE: FOR CLARITY THE CIRCUIT BOARD IS NOT SHOWN IN THIS FIGURE

Fig. 4 — Location of QCS1 Voice Station Coupler Terminals

TABLE D

Option	Description	QCS1A Action	QCS2B Action
A	Dialing required.	Remove "TAM" strap.	Remove "TAM" strap.
B	Ringing signal on "CR" and "RS" leads only.	Remove "RG1" strap.	Remove "RG1" strap.
C	Dialing on "OH1" and "OH2" leads with off hook control on CT and CR leads.	Remove "REPD" and "CTR" straps.	Remove "REPD" and "CTR" straps.
D	Ring indication by closure of contact on "RU1" and "RU2" leads. SEE NOTE.	Disconnect the transformer red leads from "RS1" and "RS2" terminals and connect them on spare terminals 20 and 30, unless Option J and B or G are specified.	Remove straps between "RS1" and "RS4", "RS2" and "RS3" unless Option J and B or G are specified.
E	20 Hz ringing (Special Assembly).	Provide Option D. Terminate 20 Hz ringing on Terminals "RS1" and "RS2".	Provide Option D. Terminate 20 Hz ringing on terminals "RS3" and "RS4".
F	Dialing not required.	Remove "TAM" strap.	
* G	Ringing on "CT" and "CR" and/or on CR and RS leads.	Factory wired "RG1" strap and red transformer lead connected to the "RS1" and "RS2" terminals.	Factory wired "RG1" strap. The "RS1" and "RS4", "RS2" and "RS3" are strapped.
H	Delete		
* J	60 Hz ringing (standard).	Leave transformer leads on "RS1" and "RS2".	Leave strap between "RS1" and "RS4", "RS2" and "RS3".
K	Off hook or dialing and off hook on CT and CR leads.	Remove "CTR" and "REPD" straps. Place strap between OH1 and OH2 terminals.	Remove "REPD" strap.
L	Off hook or dialing and off hook on OH1 and OH2 leads.		Remove "CTR" strap.

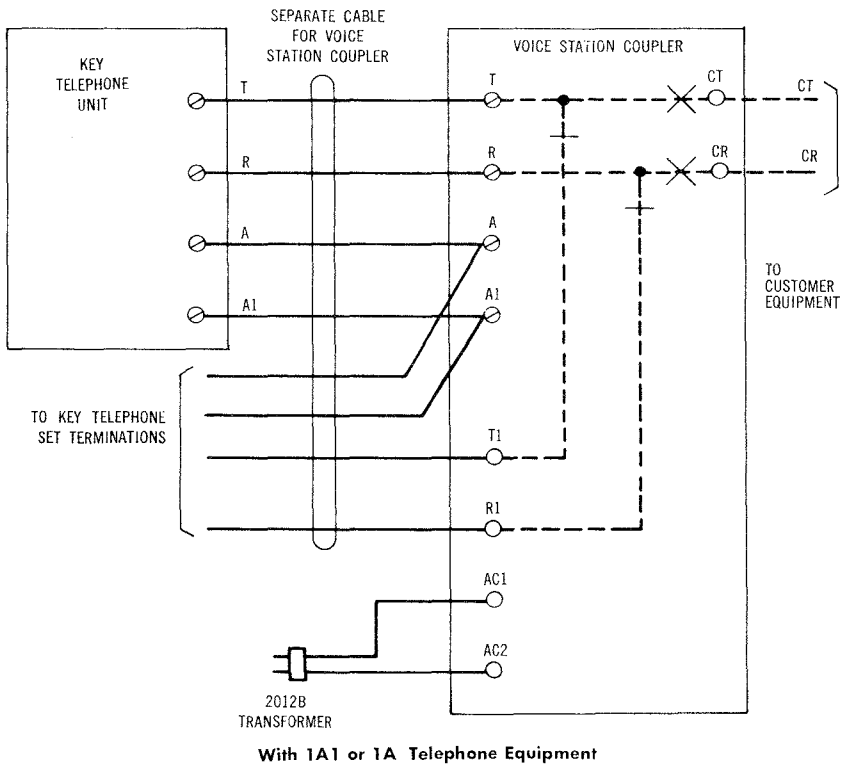
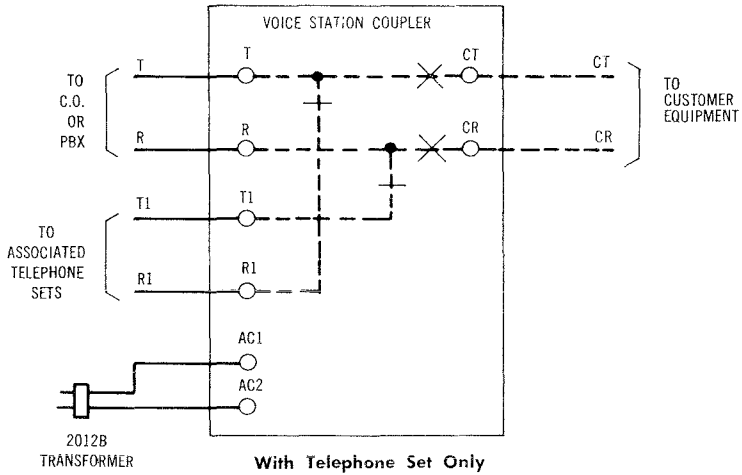
\* Options furnished with unit.

**Note:** DO NOT CONNECT THE RS1 AND RS2 LEADS TOGETHER AS THIS WOULD SHORT CIRCUIT THE OUTPUT OF THE RINGING TRANSFORMER. DO NOT DISCONNECT THE WIRE WRAPPED OR SOLDERED LEADS AT THE REAR OF THE RS1 AND RS2 TERMINALS.

**Examples** — A typical 2 wire telephone answering and recording machine requires options F, G, J and K.

A typical 2 wire alarm sending device requires options A, D and K.





**Fig. 5 — "Voice Station Coupler" Electrical Schematic**  
 (Associated Recording or Alarm Sending Equipment is provided by the Customer)

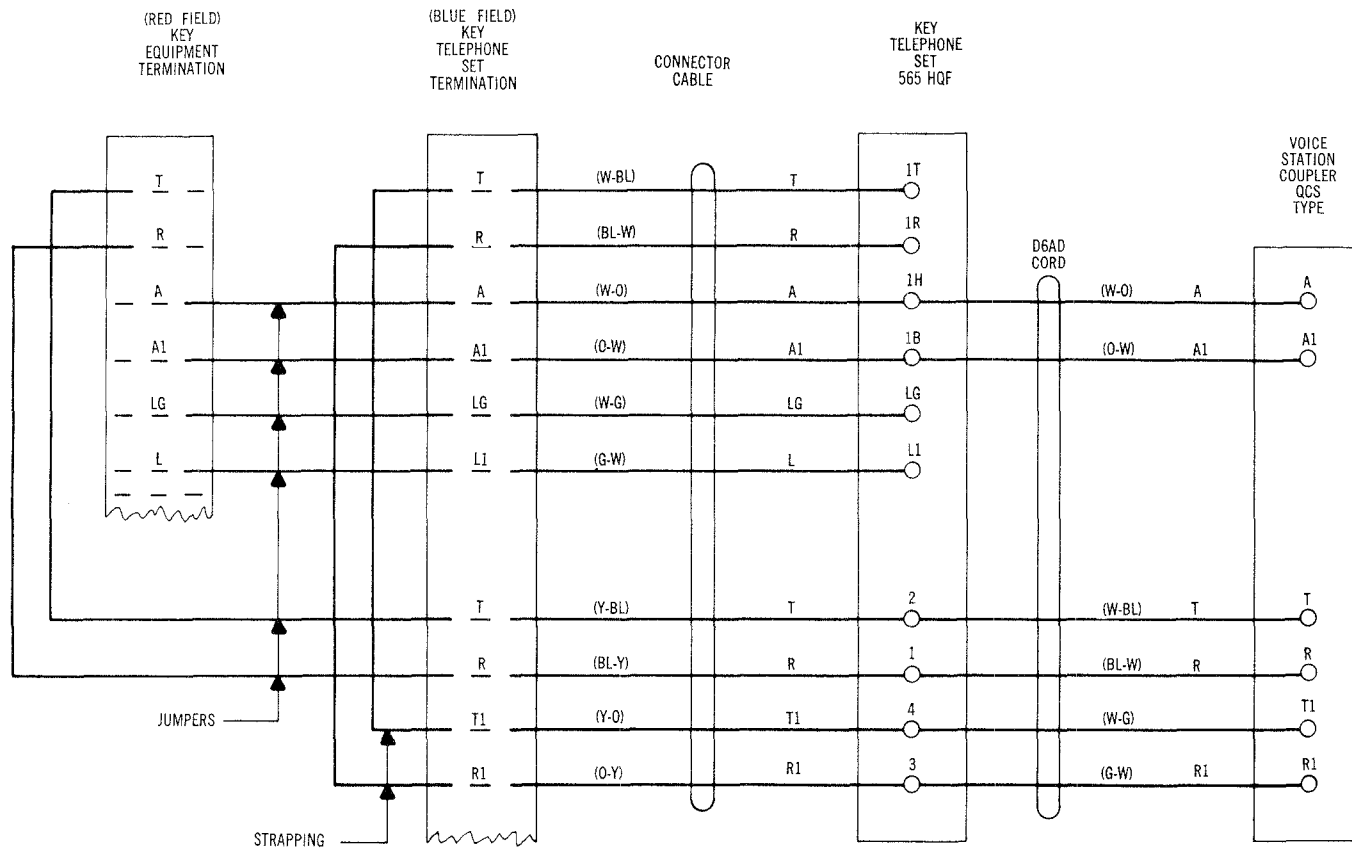


Fig. 6 - Voice Station Coupler  
Connections with 1A1 or 1A2 Key Telephone Systems.

4. MAINTENANCE

4.01 All repair forces should be familiar with the tariff provisions which generally provide for a "Maintenance Service Charge" for each customer-requested visit to a voice station coupler that is terminated with a FOK (found OK) condition. When the customer requests such a repair visit and it is subsequently determined that the trouble is *NOT* in the telephone company equipment, the employee should advise the customer there will be a Maintenance Service Charge, and notify the Test Centre to originate Form 5855.

4.02 Maintenance of the coupler on the customer's premises should be limited to visual inspection of wiring and connections, local tests, testing with test centre and replacing a defective unit.



UNDER NO CIRCUMSTANCES SHOULD THE REPAIR EMPLOYEE ATTEMPT ANY TESTS OR MAINTENANCE ON CUSTOMER EQUIPMENT.

5. TESTS

5.01 The following tests are required to ensure the proper installation of the voice station coupler and to determine the operating condition of the unit during a maintenance visit.

- Ringing indication tests
- Off-hook control tests

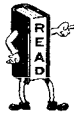
5.02 The following test equipment is required for the tests.

- 1011 type hand test set
- 81A type test set or equivalent (Buzzer)
- Standard installation or maintenance tools.



THE TELEPHONE EMPLOYEE SHOULD NOT NORMALLY CONNECT OR DISCONNECT THE CUSTOMER'S INTERFACE LEADS. HOWEVER, WITH THE CUSTOMER'S APPROVAL THIS MAY BE DONE IN ORDER TO TEST OR REPLACE A DEFECTIVE UNIT.

*CAUTION:* THE POWER MUST BE DISCONNECTED FROM THE CUSTOMER'S PROVIDED EQUIPMENT BEFORE THE TERMINALS OR INTERFACE LEADS ARE CONTACTED.



IF THE COUPLER IS INCORRECTLY WIRED BY THE CUSTOMER, DISCONNECT THE INTERFACE LEADS, VERIFY THE OPTIONS WITH TABLE D AND INFORM THE CUSTOMER AND THE TEST CENTRE.

Off-Hook Control and Dialing Tests (See Note)

5.03 *Option C and L* — Dialing "OH1" and "OH2" leads.

- (1) Connect the 81A test set across terminals TR1 and TR2.
- (2) Connect the 1011 test set to terminals OH1 and OH2 and switch to TALK, the 81A test set should indicate a short circuit between terminals TR1 and TR2 and also check for a short circuit between terminals A and A1.
- (3) Retaining the short circuit between terminals OH1 and OH2, connect the 1011 test set across terminals CT and CR. Dial tone should be heard.
- (4) Remove short circuit from terminals OH1 and OH2. Connect 1011 test set to terminals OH1 and OH2 and dial test number.
- (5) Retaining the short circuit between terminals OH1 and OH2, connect the 1011 test set across CT and CR and verify if the test number was reached. Remove short circuit and 1011 test set.

*Note:* When Option F is used, omit the dialing test.

**5.04 Option K** — Dialing on CT and CR leads.

- (1) Connect the 1011 test set to terminals CR and CT with the set switch to MONITOR.
- (2) Switch the 1011 test set to TALK, the voice station connection should go "Off-Hook" and dial tone should be heard.
- (3) With the 1011 test set connected as in (Step 2) above, using the 81A test set check that there is a short circuit between terminals TR1 and TR2 and also between A and A1.
- (4) Dial the milliwatt supply to verify transmission.

**Ringling Indication Tests****5.05 Option B** — Ringing Applied over Terminals CR and RS

- (1) Connect the 1011 test set to terminals CR and RS with the test set switched to monitor.
- (2) Call the local test desk and have a call placed to the station coupler.
- (3) When the test desk calls, the associated telephone should ring and 60 Hz ringing should be heard through the 1011 test set receiver.
- (4) If ringing can be heard connect the 1011 test set in the monitoring position across CT and CR terminals, nothing should be heard in the receiver. (Option "K") Switch the 1011 test set to talk. (Option "L") Short circuit terminals OH1 and OH2 and switch the 1011 test set to talk. The coupler should cut through to the test centre. Talk to the tester to verify the transmission through the coupler.
- (5) If ringing cannot be heard through the 1011 test set check that the ringling transformer leads are connected to terminals RS1 and RS2 or strap placed across RS1-RS4 and

RS2-RS3. Check that the 2012B transformer is plugged into a 117V electrical outlet.

**5.06 Option D** — The Customer Receives Ringling Indication as a Contact Closure Between Terminals RU1 and RU2.

- (1) Connect the 81A type test set with the switch in the C position across RU1 and RU2, the test set should not buzz.
- (2) Call the local test desk and have a call placed to the station coupler.
- (3) When the test desk calls, the associated telephone set should ring and the 81A test set should buzz during the ringling interval indicating that the ringling detector is working.

**5.07 Option G** — Ringing Applied Over Terminals CT and CR

- (1) Connect the 1011 test set to terminals CT and CR with the set switched to MONITOR.
- (2) Call the local test desk and have a call placed to the station coupler.
- (3) When the test desk calls, the associated telephone should ring and 60 Hz ringing should be heard through the 1011 test set receiver.
- (4) If ringing can be heard through the 1011 test set, (Option "K") switch the 1011 test set to talk during the ringling cycle. (Option "L") Short circuit terminals OH1 and OH2 during the ringling cycle. The ringling should be tripped and the coupler should cut through to the test centre. Talk to the tester to verify transmission through the coupler.
- (5) If ringing cannot be heard through the 1011 test set check that the strap RG1 is in place and that the ringling transformer leads are connected to terminals RS1 and RS2. Check that the 2012B transformer is plugged into a 117V electrical outlet.

## SECTION 463-233-900CA

**5.08 Options E, and J** — These options will be tested automatically when performing tests on the assigned options.

### Test Application (QCS2B Unit Only)

**5.09** In addition to the option tests previously specified in Part 5 the following test should be performed to verify proper function at time of installation. Also, the same test can be used independently by the customer, or in conjunction with the test centre to sectionalize trouble with customer equipment.

For the test to be satisfactory the coupler must be:

- Connected to the telephone line.
- 2012B transformer must be plugged into the AC receptacle.
- Option straps must be in accordance with the customer requirements.

### Test Procedures

**5.10** (1) Arrange to have the auxiliary telephone on-hook and the test switch (QCS2B)

depressed for a period of approximately 45 seconds.

(2) Originate a call to the coupler. A brief burst of ring tone followed by a similar condition to an answer from a silent termination should be observed. Listen for 15 seconds to insure the ring trip circuitry operation and finally the off-hook condition.

(3) Place a second call to the coupler to verify the on-hook control circuitry operation. A similar sequence to that in (2) should be observed.

(4) The functions tested are in sequence, the operation of the ringing detector and the off/on-hook control circuitry.

(5) Should the above operating sequence not occur as indicated, a trouble in the coupler is indicated.

(6) After a normal test, release of the test switch will restore the circuit to normal operation immediately.

## CUSTOMER RELATIONS — INSTALLERS AND REPAIRMEN

### 1. GENERAL

**1.01** On a new installation you are frequently the first representative of the Company to have personal contact with the customer. It is, therefore, very natural that the customer should consider you as the Telephone Company and judge the Company by your conduct and work.

**1.02** On trouble cases, you are the first employee the customer sees after a report of trouble has been made. It is important that you conduct yourself in such a way that the customer is left with the feeling that his complaint is receiving proper and adequate attention.

**1.03** Our customers want to deal with a friendly company, one that is sincerely interested and sympathetic. Installers and Repairmen who deal directly with our customers have it within their power to impress them favourably with the way the job is done. The manner in which our employees approach the customer and conduct themselves with the public is an important factor in creating and maintaining the good will of the public.

**1.04** This section is reissued to add information on Gaining Access and on Customer Instruction. ←

### 2. APPEARANCE

**2.01** One of the biggest factors in creating a favourable first impression is your personal appearance. Your appearance should be such that you will be readily admitted into any place you are obliged to go.

**2.02** Dress neatly and be careful of your personal appearance at all times.

### 3. SPEECH

**3.01** Use a pleasant tone of voice.

**3.02** Avoid the use of technical terms where such expressions may not readily be understood.

**3.03** Speak clearly, that you may be easily understood.

**3.04** Avoid the use of expressions which are not in good taste.

**3.05** Avoid any use of profanity.

### 4. GAINING ACCESS

**4.01** Introduce yourself by name and Company to the customer in a friendly manner, observing the accepted formalities of good manners — the removal of your hat, for instance. Where possible, address the customers by name. (If you are unable to gain access, leave a Form 606, Notice to Customer of Employee's Visit.) ↗ ↘

**4.02** Explain the purpose of your visit.

**4.03** Upon request, present your identification card cheerfully. Do not resent the customer's suspicion of strangers. It is entirely natural.

**4.04** Keep all appointments and promises or explain your reasons for not doing so.

**4.05** When work cannot be completed on the day started make an appointment with the customer for re-entry.

**4.06** Only the occupant of the dwelling, or someone appointed by the occupant, has the right to give access to the dwelling. Every attempt should be made to have a responsible party remain on the premises until you have completed your work.

**4.07** If a customer wishes to observe work operations underway, no objection should be made, unless for safety reasons.

**5. CONSIDERATION OF PRIVATE PROPERTY**

**5.01** We have the right to enter private property only where an easement has been obtained. Since you will not normally know if an easement is in effect, obtain permission from the owner before entering the property. Ask if there are any hazards you should be aware of (e.g. dogs) or any gardens you should be careful of.

**5.02** Respect customers' property. Avoid cutting across garden, etc.

**5.03** Secure the consent of the owner before pruning trees or vines. Explain exactly what you intend to do and why it is necessary.

**5.04** Do not leave bits of scrap wire, or old attachments on the property. Such scraps present an untidy appearance and could cause accidents.

**6. CONDUCT IN SUBSCRIBER'S PREMISES**

**6.01** The following general principles should be observed in all contacts with customers:

- Do not partake of intoxicating beverages on the job.
- Never blame other persons or departments for errors or mistakes. Take the necessary action to have them rectified.
- Treat all customers with equal consideration. Do not discriminate.
- Avoid entering discussions of controversial subjects with customers, such as religion, politics, etc.
- Regardless of the provocation, do not retaliate to harassment. If you are the object of such harassment, remove yourself from the location, taking only those steps immediately necessary to prevent injury. Notify your supervisor of the situation or if the situation is serious enough, notify the local law enforcement agency. In most cases leaving the location will prevent the situation from becoming more serious.

**6.02** Answer the customer's questions if you can. If you are unable to answer all of them, express regret and assure the customer that he will receive the information he seeks as soon as

possible. Refer the questions to a person who will accept the responsibility for their answers.

**6.03** Place wet weather clothing so as to avoid damage to the customer's property.

**6.04** Place your tools and material in a position that is handy but where they will not cause accidents.

**6.05** Limit your use of the customer's telephone to necessary calls, and make them as brief as possible.

**6.06** Avoid using customer's washroom facilities whenever possible. If this cannot be avoided, first obtain permission and then clean up, leaving the premises as you found them.

**6.07** Obtain permission or knock before entering a private office or a closed room in a residence.

**6.08** Do not smoke unless permission is first obtained from the subscriber. Do not smoke where it may present a fire hazard.

**6.09** Use good judgment and tact in applying standard practices and recognized policies. Recognize cases requiring unusual treatment and arrange for appropriate action.

**6.10** If tools or material are to be left on customers' premises overnight, obtain permission and place them where no inconvenience will result. As the customer cannot be held responsible this practice should be avoided wherever possible.

**6.11** A job should not be left uncompleted while you attend to other work. If this is unavoidable inform the customer of your probable time of return and ensure that this commitment is met.

**6.12** Endeavour to have the customer remove breakable objects to a place of safety while work is in progress.

**6.13** Avoid damage to the customers' property but if it should occur call it to his attention and report it properly so that appropriate action may be taken.

**6.14** Before doing work on a roof, examine it to determine if it is unsafe or likely to be damaged. Notify the property owner or tenant if either of these conditions are found.

**6.15** Extra work or favours should not be performed for a customer on the promise of monetary reward or with the hope of receiving gratuity. A gratuity usually leaves one under an obligation and should not be accepted.

**6.16** Clean up after the job and leave the premises as you found them.

## 7. PLANT SALES

**7.01** Be alert to the customer's needs for complete telephone service. Discuss the many service and equipment offerings available, make your recommendation, and present an opportunity for the customer to buy.

**7.02** Where the customer appears annoyed, politely explain the Company's wish to ensure complete service, and apologize for any undue annoyance or bother.

## 8. JOB CONSIDERATIONS

**8.01** Do your work neatly, quietly and as quickly as safety and good workmanship permit. Follow methods prescribed in Bell System Practices and other Company instructions.

**8.02** If your visit is the result of a trouble report, discuss the report with the originator and secure all necessary information.

**8.03** Listen attentively to complaints and be helpful in the solution of the customers telephone problems. Do not engage in general conversation but show a human interest in the customer and his affairs.

**8.04** If you find the equipment or service is not what the customer requires, give him what he wants, if possible, while on the job and if permitted by current regulations; otherwise make arrangements so that the necessary orders will be issued to furnish the service the customer desires. Satisfactory explanation should be given as to why the work cannot be done.

**8.05** When trouble is found to be caused by the customers' misuse, explain the matter in such a way that the customer understands that interest in his service alone prompted you to call it to his attention.

**8.06** Appreciate the fact that faulty service can be a source of real inconvenience to the customer. If he comments on this inconvenience, express your understanding of his situation, assuring him that you will clear the trouble as promptly as possible.

**8.07** If it is necessary to interrupt service on any line, plan to do so at a time that will cause least inconvenience when possible and first notify the customer.

**8.08** If, in process of performing work a n existing service is reported in trouble to you by the customer you shall endeavour to repair it and report to the Test, Control or Assignment Centre for record purposes. If you cannot clear the trouble report it immediately for appropriate attention.

**8.09** If a customer is not satisfied with the completed work, determine the reason and make any alterations required within the limitation of standard practices.

**8.10** It is usually desirable to report the completion of a job in the customers presence. If on repair visits this cannot be done, call the customer or request the tester to inform him of the completion of the work.

## 9. ACCURACY OF SERVICE ORDER

**9.01** Since the service order provides the source of information for all company records and is used for billing purposes, directory listings, Commercial records, etc., it is essential that all the information shown on the order is correct. The installer must verify with the customer that the service order accurately reflects the customer's name, initials, address, etc. Also, the equipment installed must be the same as what is shown on the order or as shown on an order corrected in the approved manner. In all cases, the Installer must notify the control centre of the changes made to an order so that the required corrections can be issued.



10. CUSTOMER INSTRUCTION

10.01 Before you leave the customer's premises, be sure the customer understands how to use his telephone equipment and directory as follows:

- On Inward Installation Visits:
  - (a) Demonstrate the correct method of using the equipment installed.
  - (b) Explain the need to wait for dial tone, and point out that other audible tones may be heard, e.g. busy tone, ringing tone, "Touch Tone" tones, etc.
  - (c) Point out possible dialing errors such as using the numeral zero in place of the letter "O", and the numeral one in place of the letter "I".
  - (d) Offer appropriate telephone directories in accordance with this table.

	Alphabetical	Yellow Pages
EAS Core	1 per tel.	1 per tel.
EAS Fringe	Local — 1 per tel.	Local — 1 per tel.
	Core — 1 per customer	Core — (on demand only) 1 per customer
All Others	Local — 1 per tel.	Local — 1 per tel.

— Where the Alphabetical and Yellow pages are included under the same cover, the Yellow pages are included only in those copies of the directory that are intended for distribution to customers at local exchange.

Example: Welland customers' copies of Directory No. 57, the Niagara - St. Catharines - Welland directory, contain only Welland Yellow pages. In Port Colborne, which is another exchange listed in the same directory, the customers receive the Niagara - St. Catharines - Welland directory with Port Colborne Yellow pages.

- The Installer shall verify that the exchange name, shown in the extreme left hand corner of the Service Order, is listed on the appropriate introductory page of the alphabetical section. Where yellow pages apply, the exchange name will be found on the first page of the yellow pages section.
- (e) Show the customer the Pink (English) or Blue (French) instructional pages in the Directory and
  - demonstrate how to determine free calling exchanges
  - Point out the customer's Area Code and demonstrate how to determine Area Codes for other localities
  - Explain the direct dialing access code and how to place a Direct Distance Dialing call.

(f) Provide the customer with a Personal Directory Form 31 and with other instructional material when provided or when required locally.

(g) If it is necessary to instruct a customer in a method of cleaning his telephone set, suggest wiping with a cloth slightly dampened in a common household detergent. The set should then be immediately dried by wiping with a clean cloth. The customer should be warned not to allow excessive moisture to penetrate the dial, receiver, transmitter and switch-hook areas. Under no circumstances should any other type of cleaning agent be used to clean a telephone set. Many wax and cleaning agents contain silicone oil which will damage plastic housings and set components.

- On Repair and Other Installation Visits:
  - (a) Ask the customer if he is having any difficulty in using the equipment or in placing Direct Distance Dialing calls.
  - (b) Where necessary:
    - show the customer the Pink or Blue instructional pages in the Directory
    - explain how to place a Direct Distance Dialing call

— provide a Personal Directory, Form-31.

**10.02** Whenever customer instructions are required for the operation of the more complex types of equipment, the Marketing Department (includes Toll Area Marketing), will notify the Traffic Service Advisor for all orders originated by the Marketing. Customer instructions, required for equipment installed on orders issued by the Business Office, will normally be given by the installer unless there are special circum-

stances which warrant a visit by a Traffic Service Advisor. In the latter case, the Plant will make special arrangements with the Traffic Department.

## **11. SAFETY**

**11.01** All prescribed safety practices should be followed while doing the work. If using a vehicle a circle check should be made before driving away.



## PLANT DEPARTMENT SALES METHODS AND HANDLING

CONTENTS	PAGE
1. GENERAL . . . . .	337
2. COMPANY OBJECTIVE . . . . .	337
3. MEASURING SALES RESULTS . . . . .	337
4. REPORTING SALES . . . . .	338
5. RATES . . . . .	338
6. SALES TECHNIQUE . . . . .	338

### 1. GENERAL

**1.01** This section provides instructions concerning Plant Department Sales to Residence and Small Business customers. It has been re-issued to:

- (a) Delete Large Business sales from the procedures;
- (b) Add instructions for the Contempra Telephone.

**1.02** Plant sales are an integral and important part of each Plant employee's job. Many customers have a limited knowledge of available telephone services and facilities, their uses, convenience and low cost. To be of maximum service, the Company must assist the customer in providing the service and equipment best suited to his particular needs. To do this, the Plant employee should utilize his experience and recommend complete service.

**1.03** The Plant and Commercial Departments have joint responsibility for the development of the Residence and Small Business Markets.

### 2. COMPANY OBJECTIVE

**2.01** The Company objective in promoting sales is:

To provide excellent service in the opinion of our customers and at the same time to maximize profits from the market.

To meet this objective:

We should recommend telephone service and equipment in a manner that will be helpful from the customer's viewpoint and appropriate for his needs.

**2.02** The following basic principles should be remembered when suggesting service and equipment improvements:

- (a) Only if the customer gains added value should he buy more service.
- (b) Only if that value continues will the sale last.
- (c) Only if the sale lasts will the Company profit.

**2.03** The most profitable sales are those which are completed while the Installer or Repairman is on the customer's premises and are handled on a "work completed" order basis. Most items sold can be installed on the initial visit, particularly in the case of homes and small business customers.

### 3. MEASURING SALES RESULTS

**3.01** Sales performance for residence and small business is measured in terms of weighted points per 100 installations or 100 repair visits, the points being allocated on the basis of revenue. Those items which produce the best revenue are allotted the most points. The weighting is as follows:

**SECTION 469-050-950CA**

Colour	2
Princess	4
Contempra	4
Touch-Tone	5
Extension	6
Additional Residence Line	10
All other items (see exceptions)	1

No credit is allowable for the sale of extra length cords, jacks, non-published numbers or automatic answering devices.

**3.02** In those cases where an item(s) on a service order is cancelled by the customer, but where the Plant employee is successful in selling a different item(s), Plant Sales credit should be taken for such items which are sold, provided that the initial year revenue produced by these items (excluding service connection charges) is equal to or greater than the revenue value of the cancelled item(s). Credit cannot be taken for substitution of one colour for another on the same type set.

**4. REPORTING SALES**

**4.01** All Plant sales are normally reported directly to a control centre in the wire section and/or by means of a Form 970A. In the latter case, the completed forms are mailed to a clerk in the Assignment Centre or District Office.

**4.02** Plant sales foreman's codes are used to identify the unit which makes the sale, e.g., 53-43, in which the first two digits "53" identify the District, the third digit "4" identifies the unit and the fourth digit "3" identifies the foreman. A unit is defined as the group reporting to a District second level supervisor, e.g., Plant Manager, Installation Manager, Repair Manager.

**4.03** To identify a Plant sale, the item(s) sold must be bracketed on the service order for identification purposes and a foreman's code must be used to identify the unit making the sale. An alphabetical prefix I, R or O shall be used to identify that the sale originated from an Installation visit, a Repair visit or an Other Contact, respectively, e.g., I53-43, as outlined below:

- (a) Sales made by a Plant employee in connection with a visit to the customer's pre-

mises to work a service order shall be reported, using an I Prefix.

- (b) Sales made by a Plant employee in connection with the handling of a customer trouble report shall be reported, using an R Prefix.

- (c) Sales made by Plant contact and non-contact employees in connection with field work on planned programs such as transmission improvements, central office cutovers, etc., shall be reported, using an 0 prefix.

**4.04** If a foreman's code and/or the bracketed item, is not shown on the service order, sales credit will not be recorded by the Accounting Department. It is important, therefore, to ensure that when transmitting sales information, the placing of brackets and foreman's codes is emphasized.

**5. RATES**

**5.01** Plant employees should be familiar with the recurring and non-recurring charges. What would the total additional cost be for the following:

- (a) Contempra Extension .....
- Touch-Tone .....
- (b) Regrade .....
- Princess .....
- Extra Listing .....

When in doubt about rates, consult the Rate Card (Form 142) or call the local Business Office.

**6. SALES TECHNIQUE**

**6.01** The key to a successful sales program is the "Effort" that is made in trying to promote the use of our services. It is also important that the effort be made in an "effective" manner.

**6.02** To assist Plant employees to make an effective sales presentation, the following procedure is a recommended selling sequence which should be used on visits to the residence and small business customers. It is very important to use an intelligent and sincere approach in

our dealings with customers and to modify the approach to suit an individual customer's needs.

**6.03** Selling sequence on every residence and small business visit:

(a) Observe the Service Order or Repair Work Order.

(b) Bring in a Contempra Telephone. If a Contempra is included in the existing service, bring in an alternate product e.g. Touch-Tone or Princess.

(c) Be friendly and show your willingness to be helpful.

(1) Use customer's name and give your own name.

(2) Identify that you are from the Telephone Company and state the purpose of your visit.

(d) Display equipment as follows:

(1) If there is no Contempra set working, display this item while performing inside or outside work.

(2) In order to get the customer's consent to display this set, we can say:

"Perhaps the girl in our Business Office suggested a Contempra, I have this telephone here, there is no obligation on your part; you can look at it while I'm working."

OR

"I am going outside to establish your service. While I am working outside I would like you to see a Contempra. You are under no obligation at all Mrs."

(3) If telephone on premises is a Contempra, do not display this item at this time.

(4) Make no attempt to negotiate the sale of this item at this time.

(5) Proceed with your work.

(e) Gather the facts by observation and questions.

(1) Remember we are the telephone experts.

(2) Remember the four basic areas for telephone service:

(a) Cooking.

(b) Utility.

(c) Living.

(d) Sleeping.

(3) Two methods in fact finding.

(a) Observation

Small children.

Teen-agers

Elderly people.

Size of house.

Colour scheme.

Location of Telephone.

Available space for additional telephones.

Type of service ordered.

Patio.

Recreation Room.

Work shops.

Sewing rooms.

(b) Conversation

Ask open type questions:

What, who, how, when, where, why, if.

Avoid closed type questions:

Do, did, does, can, is, are, have, may, has, would, could, should.

Be a good listener.

Avoid creating objections by:

— words

— actions

— attitude

— incomplete or wrong information

(f) The package method of selling:

(1) Two questions to use:

(a) "I notice you have several rooms and only one telephone. If you had the opportunity of having an extension phone installed without a service charge while I'm here, where would you find it most convenient?" (Service charges are made on business visits and repair visits.)

- (b) "Why would you find it most convenient there?"  
 Emphasize the benefits of having a phone in that particular area.
- (1) Cooking area benefits.
    - Save steps
    - Avoids spoiling food
    - Safety
    - Supervision of children
  - (2) Living area benefits:
    - Convenient when relaxing
    - Save steps
    - Wont' miss calls
  - (3) Utility area benefits:
    - Save steps
    - Cuts down on interrupted work time
    - Children not left in unattended area near washer, dryer, power tools
  - (4) Sleeping area benefits:
    - Emergency night calls
    - Privacy
    - Security at night
    - Eliminates running down stairs, accidents
- (2) Proceed with the Contempra selling method.
- (a) Display the Contempra Set.
  - (b) Demonstrate the use of the handset (dialing, recall button, etc.)
  - (c) Highlight the benefits.
    - (1) Progressive new styling — contemporary design.
    - (2) Comfortable — handset cradles in palm of hand.
    - (3) Handy:
      - No need to hang up between calls — use "recall" button.
      - No need to reach or turn to dial
- Touch-Tone set allows one-hand dialing
- (4) Versatile — can be used for either table or wall.
  - (5) Longer Handset Cord — 5½ feet long allows more freedom of movement when talking.
- (d) Mention the new colours available:
    - Bright Red
    - Deep Blue
    - Mauve
    - Deep Turquoise
    - Green
    - Pale Yellow
    - Beige
    - Ivory
    - Warm White
  - (e) Mention the choice of Touch-Tone or Rotary Dial.
- (3) Proceed with the Bell Chime selling method.
- (a) "By the way, have you heard our new sound in telephone bells? This bell does three things:
    - it has a soft ding dong chime.
    - it can be made loud ringing or it can be adjusted to ring softly.
    - simply adjust this lever for each of the desired sound."
  - (b) Demonstrate the Bell Chime by connecting it to the subscriber's line by means of a cord.
  - (c) Highlight the benefits.
    - (1) Three bells in one
    - (2) Adjustments for sleeping, sickness, babies, etc.
    - (3) Relaxing ding dong
    - (4) Can be installed anywhere.
  - (d) Mention that there is a choice of colour: ivory or gold.
- (4) Proceed with the selling method of a Regrade if applicable.

(a) "I notice you have a two-party line. As you know, you pay \$ . . . for the first half of the line. For very little extra a month, you could have a line all to yourself."

(b) Highlight the benefits.

- (1) Privacy
- (2) Security
- (3) Instant service
- (4) Won't miss calls
- (5) No party line irritation

(5) Quote the price.

"While I'm here I can install the extension, Contempra and the Individual line. There are no additional service charges (if applicable) and all it will cost you is \$ . . . a month."

e.g.,

Ext	\$1.25 (Res)
Contempra	1.75
Regrade	1.40
	\$4.40 (Quote this figure only)

or

Ext	\$1.85 (Bus)
Contempra	1.75
	\$3.60 (Quote this figure only)
Quote the service charge separately where one applies (e.g., on a repair visit or business visit.)	

(6) Ask for the order by offering a

(a) Choice of Contempra or Bell Chime

Question

"What colour would you like me to install?"

**NOTE:** An answer to this question in the affirmative is the authority to proceed.

(b) Choice of location for Contempra, Bell Chime and/or Extension.

Question

"Would you like it installed here, or here?"

(7) When there is no additional service charge, and there is any hesitation

(a) Suggest that the customer "try it for a month. If you don't find it convenient, give us a call and we will remove it for you at no extra charge and all it will cost you is the one month rental."

(b) "You will find it very convenient and you will be saving money by having it installed now."

(8) Proceed with the installation.

(9) Attempt to sell — Touch-Tone (includes Princess Touch-Tone)

— Princess

— Colour

as appropriate.

**NOTE:** This should be attempted after the wire has been installed and you are ready to install the telephone sets.

(a) Emphasize the benefits

(1) Touch-Tone — Easy to dial  
— Quicker to Call

— All coloured sets provided — no colour charge

— Fewer wrong numbers

(2) Princess — Dainty  
— Compact  
— Easy to handle  
— Night light feature

(3) Colour — Matches decor  
— Attractive  
— Provides modern service

(b) Quote the rates and charges  
Touch-Tone only \$1.75 per line charge or \$2.50 for business (all sets colour)



**SECTION 469-050-950CA**

Touch-Tone  
Princess \$1.75 per line charge  
or  
\$2.50 for business  
+\$6.00 Princess charge  
(non-recurring).  
+\$0.85  
Princess only \$6.00 non-recurring  
-\$0.85 recurring  
Princess  
charge.  
Colour — \$9.00 non-recurring.

(c) Ask for the order.

- (1) "Which colour or type would you like me to install?"
- (2) "Would you prefer the Princess telephone in your bedroom?"

(10) Complete the installation.

## **INSPECTIONS ON STATION VISITS**

### **INSTALLERS AND REPAIRMEN**

#### **1. GENERAL**

**1.01** This section covers the inspection of the station apparatus, inside wiring, drop and block wires, terminals, etc., made by installers and repairmen when visiting the subscriber's premises in connection with service order work or with clearing trouble reports.

**1.02** This section is reissued to bring it up to date. Due to extensive changes, marginal arrows have been omitted.

**1.03** This inspection may only be omitted upon the approval of local supervision when due to workload, it would tend to hinder the prompt restoration of service.

**1.04** The extent of the inspection by class of service is provided below. Included in the inspection of the telephone equipment, shall be an inspection of associated inside wiring, outside service wires and the working terminal involved.

- Residence — All on-premises equipment
- Coin Telephone — All equipment associated with the particular station.
- Business — Station or stations and their associated apparatus reported or covered by the service order.

**1.05** All defects which the craftsmen is equipped to clear, shall be corrected at the time of inspection. When the defect cannot be cleared at the time, due to workload or because of the lack of training or equipment, the craftsman shall report it on a Form 732.

**1.06** A defect shall be considered as anything not in accord with the provisions of Bell

System Practices sections. Good judgement must be exercised to ensure that the appearance of the telephone equipment is in keeping with the surroundings; eg. a workshop telephone might need to look only moderately well, whereas one in an attractive office would normally be expected to present a well-kept appearance.

**Note:** It is not always feasible to produce an exact colour match between the components of a coloured telephone. A coloured telephone should not be replaced because of colour mismatch unless requested by the customer.

**1.07** The service order work or trouble condition, necessitating the visit to the subscriber's premises, should be cleared or completed prior to the inspection being made. There may be some instances when the specialized test facilities of the Exchange or Toll Testboard are required.

**1.08** Customer owned telephones connected to working services should be referred to local supervision. Customer owned attachments should be handled in accordance with District instructions.

#### **2. INSPECTION OF STATION EQUIPMENT**

**2.01** The procedures to be followed when inspecting items of common types of apparatus are detailed in the appropriate Bell System Practices section.

#### **Number Card**

**2.02** Check the general condition as to the legibility of the number card, the condition of the cellulose window, proper type card and the correct telephone number. Replace any parts found to be defective, incorrect or missing. "Easy Stick" number cards and those number cards

## SECTION 469-052-930CA

where entries have been made in pencil or ink, are to be replaced.

### Directories

**2.03** Ensure that current directories are provided and are in good condition. At public telephone stations, ensure that the directories are properly located. At multiple installations of public telephones, where out-of-town directories have been placed, advise the tester of those directories requiring replacement.

### 3. TESTING

**3.01** Operational tests are to include:

- (a) Dial speed and ringer test.
- (b) Verification of A.N.I. modification for tip parties where required.
- (c) Verification of hold and special features.
- (d) Testing of WATS lines and foreign exchange services with the appropriate test centre.
- (e) Transmission and noise measurement tests of Special Service line as per Bell System Practices sections.
- (f) A verification of the line on all new installations or where changes of Central Office facilities are involved. This verification shall be made by means of a call back to one station from the installation control centre. When the control centre is closed, the call back shall be requested from the test centre. On orders completed after the Test Centre is closed, the call back shall be made the following morning by the Control Centre.

**3.02** Where the testing requirements are beyond the capability or scope of the craftsman, the assistance of the tester is to be obtained.

### 4. CLEARING AND REPORTING OF DEFECTIVE OUTSIDE PLANT CONDITIONS

**4.01** The cable terminal from which the service is working shall be inspected, except in

those cases where the terminal is not in the close vicinity or where accessibility would pose a problem.

### Cable Terminals and Poles

**4.02** The inspection of cable terminals and poles shall include such items as:

- (a) The terminal is properly and securely mounted.
- (b) The cover or door of the terminal is secure and operates properly.
- (c) Foreign material in the interior of the terminal.
- (d) The binding posts and fuses of the line being worked on to ensure that the connections are tight.
- (e) Wiring within the terminal is properly routed and terminated.
- (f) An inspection of the pole steps to determine the steps that are missing or defective.

**4.03** The provisions of Para. 1.05 shall also apply to the defects encountered by the craftsman on Outside Plant items.

### Other Plant

**4.04** Apart from the inspection of station equipment wiring, cable terminals and poles, all craftsmen should continually be on the alert to observe conditions which do not appear to be in accordance with standard practices. Conditions such as power hazards, tree interference with wires or cables, broken or leaning poles, loose or improperly supported wires or cables, missing cable rings, broken lashing wire, etc., which cannot be economically handled, should be reported by means of a Form 732 or in accordance with District instructions.

## INDUCTIVE NOISE

## 1. INTRODUCTION

**1.01** This section covers the relative contributions to inductive noise which may be controlled or moderated by the proper use of subscriber station equipment.

**1.02** This section is reissued to incorporate supplement and update information.

**1.03** Inductive noise is noise which is induced in the telephone system and brought to the telephone receiver electrically. Inductive noises arise most often from sources external to the telephone plant, such as induction from exposure to foreign systems, particularly power circuits. Surrounding noise (room noise) picked up by the transmitter and carried on the circuit is not included. For correction of room noise interference, refer to the Sections entitled, "Apparatus for Use at Noisy Locations."

## 2. GENERAL



*Station apparatus and associated wiring should not be located close to possible sources of inductive noise than the separations specified in the sections covering wiring, clearances, and station set location.*

**2.01** Radio frequency induction from radio transmitters should be corrected as recommended in the Section entitled, "Radio Signal Suppression in Telephone Sets."

**2.02** Poor insulation or resistance unbalance of the telephone circuit contributes to noise resulting from inductive interference. Locating and eliminating the cause of high leakage or resistance unbalance may adequately solve the problem.

**2.03** The balance-to-ground of the customer station sets is often the controlling factor in the susceptibility to inductive noise.

**Note:** The unbalance between the two sides of a line which has only the capacitance afforded by the air dielectric between the tip and ring shall not exceed three volts on the meter at the local test desk.

## 3. STATIONS EMPLOYING CAPACITOR-TYPE RINGING BRIDGES

**3.01** Both low-impedance or red-striped ringers, when used for grounded ringing, increase the line's susceptibility to inductive noise. All low-impedance ringing bridges on a line troubled with inductive noise should be changed to high-impedance capacitor-type ringing bridges. The high-impedance ringing bridges connected on each side of a line should balance within certain limits. The unbalance between the two sides of a line shall not exceed three units. The Section entitled, "Ringing Bridge Limitations," lists figures as units of unbalance which may be applied to the various ringing bridges to determine the unbalance between the two sides of the line.

**3.02** B-type ringers, which were manufactured with magnetic iron cores in the ringer coils, have red-striped markings on both coil covers. They are lower in impedance and increase the susceptibility to inductive noises on grounded ringing party lines. It may be necessary to replace them. The ratio of receiver noise-to-noise-to-ground is in the order of 5 db greater for sets with magnetic iron core ringers (red-stripped) than for sets with permalloy core ringers.

**3.03** Inductive noise encountered at local battery talking tip-party stations, which employ 266A Inductors as a bridge in the receiver circuit, may be moderated by reversing the leads of the 266A Inductor, as shown in the sections covering such local battery set connections.

**3.04** The unbalances due to nongrounded ringing bridges are small and receiver noise resulting from the action of induced voltages on these unbalances is usually negligible.

## SECTION 500-112-100CA

**3.05** When inductive noise is excessive on lines with high-impedance capacitor-type grounded ringing bridges, tubes or ringer isolators may be utilized to minimize the effects of the induced voltage.



*In areas where tubes or ringer isolators are required, individual lines should be wired metallic (not as ring party) to minimize the possibility of a noise problem.*

**3.06** From the standpoint of susceptibility to inductive noise, a grounded station ringer equipped with a tube or ringer isolator is equivalent to a nongrounded ringer (provided the induced voltage between the line and ground is not high enough to cause conduction of the tube, or exceed the limits of the ringer isolator, and that tip party identification is not used).

### 4. COIN COLLECTOR STATIONS

**4.01** Dial and manual prepay coin collector lines are susceptible to inductive noise in exposed areas. Older types of prepay coin collectors have a large shunt unbalance caused by the connection of the coin relay from one line wire to ground. Later types correct this unbalance by the use of centre-tapped 101B Induction Coils or 425B Networks with the coin relay connected from the centre tap to ground.

**4.02** Where noise problems arise with older-type coin collectors, it will be necessary to replace the coin collector arrangement with one employing a 101B Induction Coil or 425B Network.

**4.03** Earth potential or long loops may interfere with the proper operation of the coin relay. Earth potential may be either positive or negative. If negative, it opposes the negative coin battery and reduces the coin return range; similarly, if positive, it reduces the collect range. Station equipment is available which employs a sensitive low-resistance relay (S36) wired in series with the coin relay which, when it operates, multiplies the tip and ring conductors at the station and thus reduces the total resistance in the control path, especially after the customer hangs up. In dial offices, coin collect and return current

is normally applied to both tip and ring conductors at the central office. At some manual offices only the tip side is used, in which case the use of this type of subscriber equipment would be of no benefit without central office coin line circuit rearrangements.

**4.04** Available subscriber sets employing S36 Relays and also 101B Induction Coils for use at coin collectors stations are covered in the Section entitled, "Subscriber Sets, Common Battery, Induction Coil Type, Connections." Network types are covered in the connection Sections for 685A Subscriber Sets.

**4.05** The electromagnet associated with 10-cent operation is connected in series with the line. In order to minimize the effect of the electromagnet on transmission, a 452A or B 4-uf Capacitor is connected in parallel with it. In areas of low frequency inductive interference it may be necessary to increase the size of this bypass capacitor, in order to keep the noise pickup within acceptable limits. A Mallory TCN 3520 Electrolytic Capacitor (20 MFD 350 volts non-polarized) or equivalent may be used for this purpose. Purchase locally.

**4.06** At common battery talking coin collector stations, the above electrolytic capacitor will only improve the noise condition when used with sets equipped with 101B Induction Coils or 425B Networks.

### 5. DEVICES TO MINIMIZE INDUCTIVE NOISE

**5.01** Three different electrical devices may be used to minimize the effect of inductive noise.

- 426-type, 3-element, gas-filled cold cathode electron tube (shown for maintenance purpose only).
- 425-type, 4-element, gas-filled cold cathode electron tube (shown for maintenance purpose only).
- PO895087 solid-state ringer isolator kit (For new installations).

**5.02** Table A shows usage of the tubes and ringer isolator for the various party services.

**5.03** Tube isolators usually require either superimposed ringing (ac ringing voltage plus a dc bias voltage), or a pulsating ringing current, in order to assure satisfactory ringer operation. If a suitable supply is not available, tube isolators cannot be used.

**5.04** The limitations on the number of tube equipped ringing bridges and the permissible loop resistance are more restricted than for regular capacitor-type ringing bridges. The reduction in limitations is different for various central office ringing arrangements. For the limitations, refer to Section 500-114-100.

**5.05** Tube isolators may be used on 2-party or multi-party lines provided tip-party identification is not required.

#### **3-Element Tube (426-Type Shown For Maintenance Purposes Only)**

**5.06** The 426-type 3-element tube may be added to high-impedance grounded ringers to minimize the effects of inductive noise.

**5.07** When 3-element tubes are used to combat inductive interference, station ringers should be connected as shown in Fig. 1.

**5.08** For positive stations on lines experiencing inductive interference, induced noise voltages of 20 to 30 volts RMS may be sufficient to cause the control gap to conduct. This conduction ("flashover") will result in noise (sputtering) on the line during conversation.

**5.09** For negative stations, the control gap is bridged across the line, and the main gap is connected between the line and ground in series with the ringing bridge (Fig. 1, negative stations). The main gap will normally withstand 70 to 80 volts RMS of induced noise before "flashover" (conduction) occurs.

**5.10** For additional information on the 3-element tube, see Section 501-320-100.

#### **4-Element Tube (425-Type Shown For Maintenance Purposes Only)**

**5.11** The 425-type 4-element tube may be required in cases where the induced voltage on the telephone line exceeds the values for satisfactory operation of the 3-element tube.

**5.12** The control gap of the 4-element tube is bridged across the line (and the main gap connected between the line and the ground) for both positive and negative stations (Fig. 2). The line is protected from induced noise by the high breakdown point of the main gap.

**5.13** For additional information on the 4-element tube see Section 501-320-100.

#### **Ringer Isolator (PO895087 Kit Of Parts)**

**5.14** The PO895087 Ringer isolator kit should be used where induced noise voltage is a problem (up to 140 volts RMS) it should also be used as a replacement for defective 425-426 type tubes.

**5.15** This isolator kit is to be mounted loose in telephone sets and subscriber sets etc. No mounting bracket is necessary as its small size and weight allows it to be placed in any available space. The only necessary precaution required is to dress the leads in such a way as to prevent any interference with dial contacts, hookswitch or ringer armature. Bridging of the ringer isolator leads to ringer may be made through the use of QCM12A Connector.

**5.16** The ringer isolator is intended for use with all grounded ringers except those used in 4-party full selective and 8-party semi-selective ringing service (Fig. 3). The ringer isolator may be used at subscriber stations requiring tip party identification. Identification connections are made in the normal manner, but only the 2650-ohm identification circuit should be used. One ringer isolator is required for each grounded ringer (Fig.5).

**TABLE A**

DEVICE	2-PARTY	DIVIDED CODE (MULTI-PARTY)	4-PARTY SEMISELECTIVE RINGING	8-PARTY SEMISELECTIVE RINGING	2-PARTY WITH TIP PARTY IDENTIFICATION
3-Element Tube	●	●	●	●	
4-Element Tube	●	●	●	●	
Ringer Isolator	●	●	●		●

5.17 Check the following locations for information on ringer isolator connections:

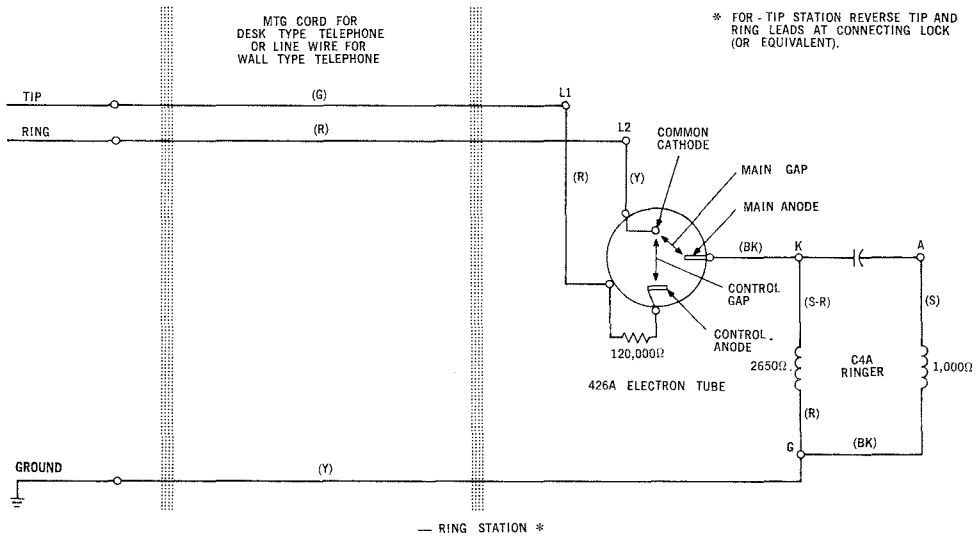
- 3-Element Tube Connections (Fig. 1)
- 4-Element Tube Connections (Fig. 2)
- Typical Ringing Bridge Connections (Fig. 3)
- Tip party Identification Connections (Fig. 4)
- Princess Connections (Para. 5.20)
- Contempra Connections (Table C)
- Bell Chime Connections (Fig. 5)
- 592 Subscriber Set Connections (Figs. 6 or 7)



*Lines equipped with ringer isolators cannot be tested for continuity by conventional test desk procedures. This device should be installed in such a manner as not to interfere with electrical or mechanical operation of the telephone set.*

5.18 For additional information on the P895087 Kit of Parts (ringer isolator see Section 501-375-100.

5.19 If the installation of ringer isolators does not clear the noise problem, refer to Section 331-840-901 entitled, "Loop Noise Investigation and Reduction for Additional Corrective Action."



**Three Element Tube**

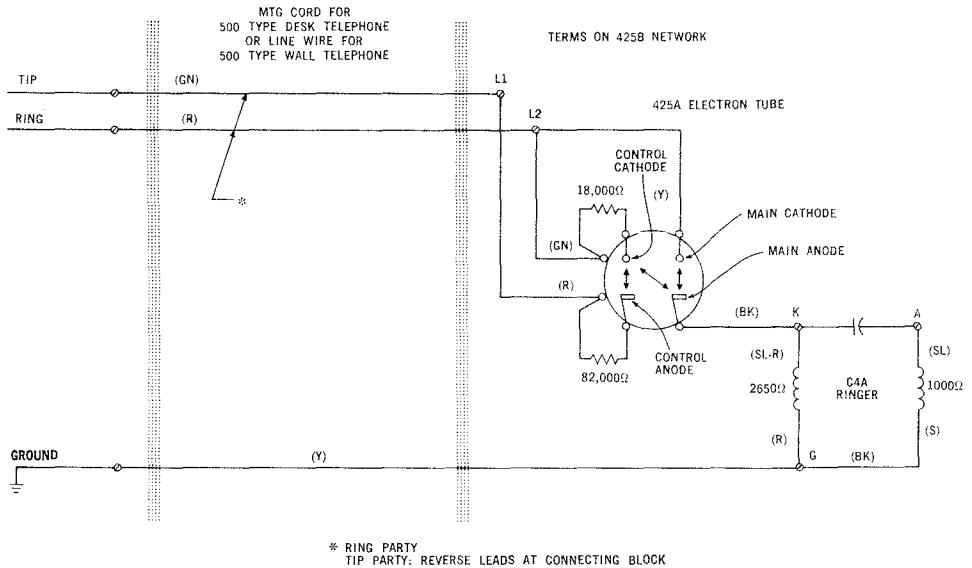
Modify the telephone set for the three element tube as follows:

1. Connect the RED lead from the 426A gas tube to post L1 of the 425B network.
2. Connect the YELLOW lead from the gas tube to post L2 of the network.
3. Connect the BLACK lead from the gas tube to post K of the network.

4. Remove the SLATE-RED ringer lead from post A and connect to post K.
5. Remove the SLATE ringer lead from K and connect to A.
6. Remove the RED ringer lead from L2 and connect to G.

The telephone is wired as a Ring party; reverse the leads at the connecting block for a tip party.

Fig. 1 - 3-Element Tube, Typical Ringing Bridge Connections



#### Four Element Tube 425A

Modify the telephone set for the four element tube as follows:

1. Connect the RED lead from the 425A gas tube to post L1 of the 425B network.
2. Connect the GREEN lead from the gas tube to post L2 of the network.
3. Connect the YELLOW lead from the gas tube to post L2.
4. Connect the BLACK lead from the gas tube to post K of the network.

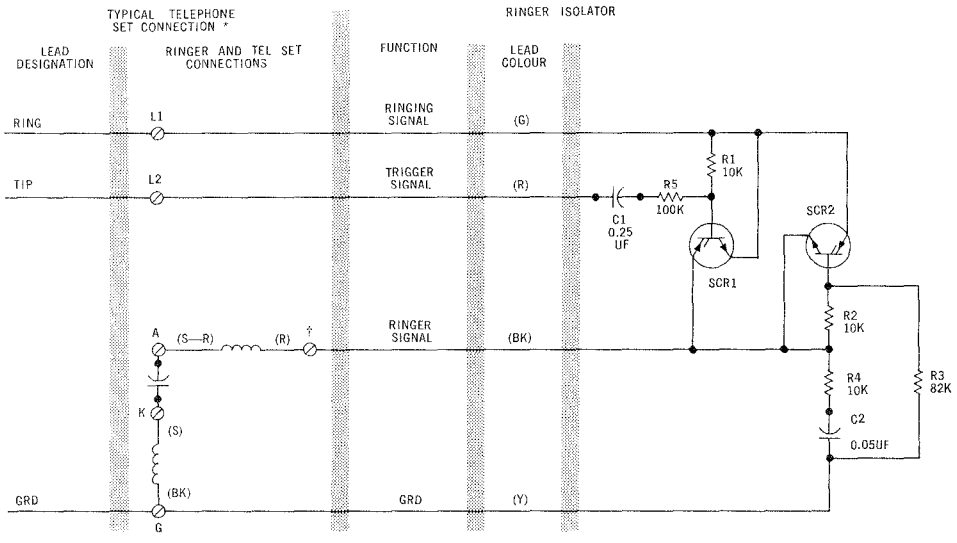
5. Remove the SLATE-RED ringer lead from post A and connect to post K.
6. Remove the SLATE ringer lead post K and connect to post A.
7. Remove the RED ringer lead from post L2 and connect to post G.

The telephone is wired as a Ring party; reverse leads at the connecting block for a tip party.

Fig. 2 — 4-Element Tube, Severe Induction Ringing Bridge Connections



SECTION 500-112-100CA



\* RING STATION. FOR TIP STATION REVERSE TIP AND RING LEADS AT CONNECTING BLOCK (OR EQUIVALENT).

† USE SPARE TELEPHONE SET TERMINAL OR D—161488 OR QCM9A CONNECTOR.

Fig. 3 — Ringer Isolator, Typical Ringing Bridge Connections

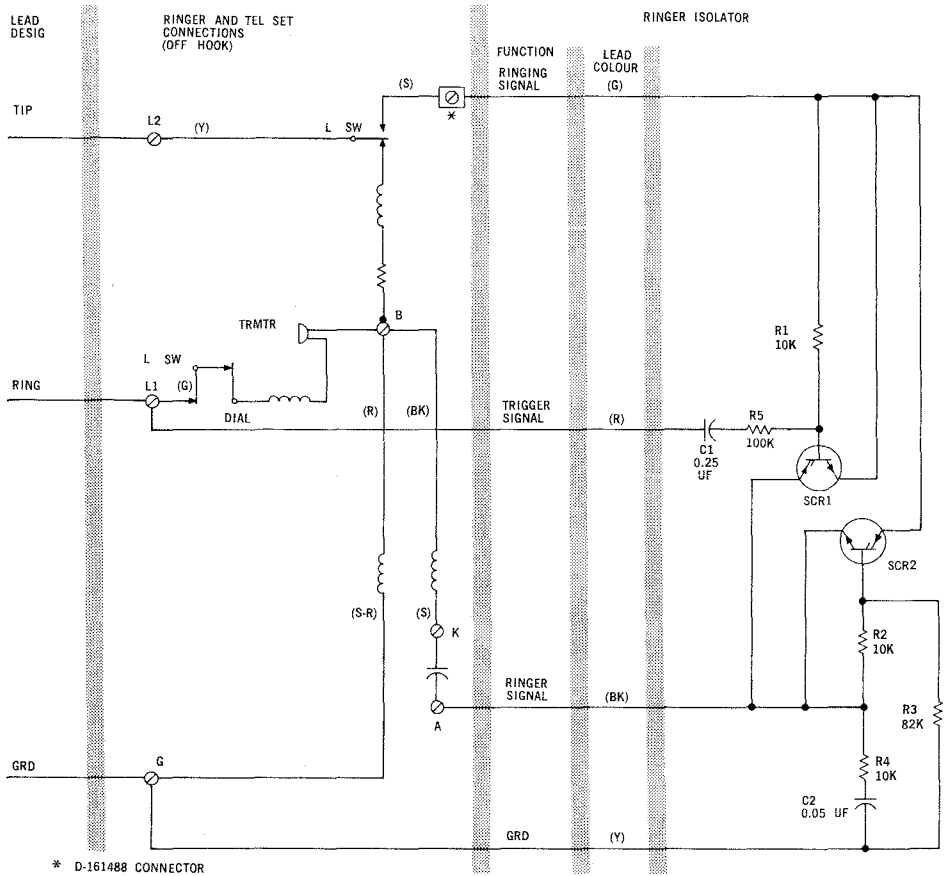


Fig. 4 — Ringer Isolator Connections for Tip Party Identification —2650 Ohms

**SECTION 500-112-100CA**

**Princess Set Connections**

**5.20** The 701B Princess Set associated with the E1A Ringer cannot be fitted with the PO895087 Ringer isolator due to space limitation. When it is required, substitute the 702BQ1A Princess Set and wire in accordance with the steps outlined below:

- (1) Disconnect Red and Green mounting cord leads from L2 and L1 respectively.
- (2) Insert **PO96B583 Connectors** in L2 and L1 terminals (Flatten the shanks of the connectors with long nose pliers, first).
- (3) Insert the Red and Green mounting cord leads in the rear slots of the PO96B583 Connectors (Red to L2, Green to L1).

- (4) Disconnect Red ringer lead from K.
- (5) Using a QCM12A or PO96B583 Connector, splice Red ringer lead to one lead of a 548A Capacitor (order separately).
- (6) Using a QCM12A or PO96B583 Connector, splice the other lead of 548A Capacitor to BK lead of PO895087 ringer isolator.
- (7) Terminate Yellow lead of ringer isolator of G terminal of network.
- (8) Terminate Red and Green ringer isolator leads in front slots of PO96B583 Connectors as per Table B.

**TABLE B**

Component	Lead Colour	Ring Party	Tip Party (No. A.N.I.)	Tip Party (A.N.I.)
Ringer Isolator	R	L2	L1	L1
	G	L1	L2	L2

- Notes:**
- 1 Refer to Table A of Section 502-710-403CA for remaining set connections.
  - 2 Install Ringer Isolator between the legs of the Dial Mounting Bracket.
  - 3 Dress the 548A Capacitor along the front of the network.

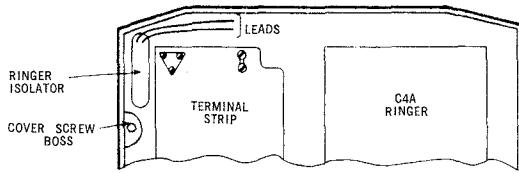
**5.21 Contempra Set Connections (Table C)**

**TABLE C**

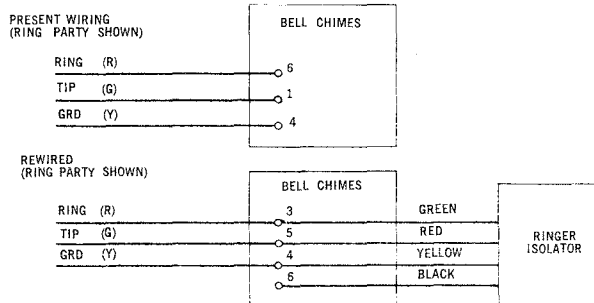
Set Wiring	Lead Designation	Colour	Ring Party	Tip Party (See Note 1)
RINGER		R BK S S-R	MOVE FROM L3 to G1 LEAVE ON G LEAVE ON K LEAVE ON A	MOVE FROM L3 to G1 LEAVE ON G LEAVE ON K LEAVE ON A
RINGER ISOLATOR (INSTALL BETWEEN HOOKSWITCH AND NETWORK)		R G BK Y	CONNECT ON L1 CONNECT ON L3 CONNECT ON G1 CONNECT ON G	CONNECT ON L3 CONNECT ON L1 CONNECT ON G1 CONNECT ON G
LINE WIRING OR MOUNTING CORD	TIP RING GRD	G R Y	L1 L2 G	L2 L1 G
SWITCHHOOK LEADS		S S-Y S-BR	L3 L2 C	L3 L2 C

**Note 1:** This set cannot be wired for A.N.I.

INSTALL THE RINGER ISOLATOR AS SHOWN BELOW:

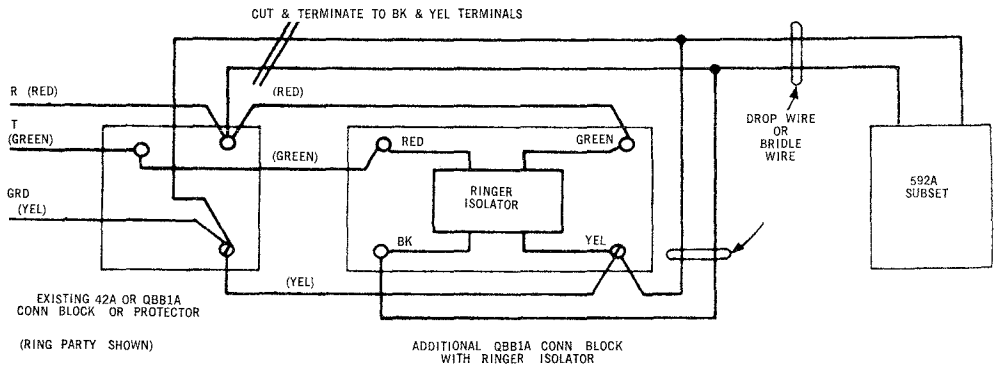


CONNECT AS FOLLOWS:



**Note:** For tip party (no A.N.I.) reverse red and green line wires and red and green ringer isolator leads.

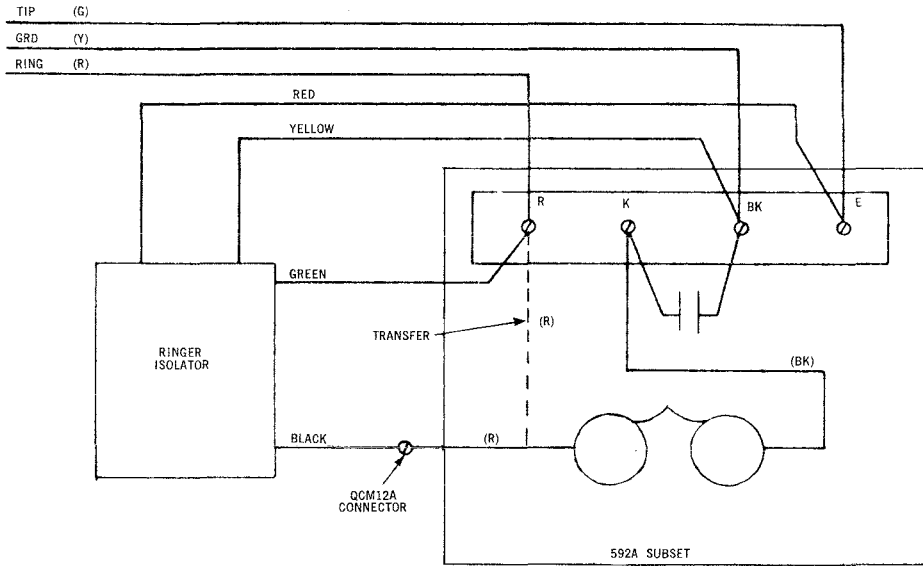
Fig. 5 — Bell Chime Connections



**Note:** For tip party (no A.N.I.) reverse the red and green line wires and red and green ringer isolator leads.

Fig - 6  
592A Subscriber Set Connections  
(Served by a 2 Wire Conductor)

SECTION 500-112-100CA



(RING PARTY SHOWN)

1. Dotted line shows original wiring.
2. Install Ringer Isolator over the top of B1A ringer (in front of terminal strip.)
3. For tip party (no A.N.I.) reverse the red and green line wires and red and green ringer isolator leads.

**Fig. - 7**  
**592A Subscriber Set Connections**  
**(Served by 3 or 4 Wire Conductor)**

**RINGER CONNECTIONS**  
**TIP-PARTY IDENTIFICATION**  
**FOR STATIONS CONNECTED TO LONG-LINE EQUIPMENT**

**1. GENERAL**

**1.01** Ringer leads must be reversed at 2-party tip stations with ground identification when these stations are connected to a long line circuit. This prevents bell tap. To do this, reverse all four ringer leads. This is necessary to prevent losing the proper tip-party identification. A typical example of these connections is shown in Table A.

**TABLE A**  
**RINGER CONNECTIONS OF 500D TELEPHONE SETS**

2650Ω IDFY GRD		
Ringer Lead	From	To
S-R	G	B
R	B	G
BK	B	K
S	K	B

- 1.02** This information will be included in the next revision of the individual sections showing Ringer Connections, where applicable.
- 1.03** This information is particularly important when using 238A Amplifiers on long lines.



## TELEPHONE APPARATUS COLOUR

### 1. INTRODUCTION

**1.01** This section covers standard colours in which telephone sets and associated station apparatus are currently being manufactured, see Table A.

- Handsets, cords, and dials are available in colours to match these telephone sets.
- No provisions have been made for continued production of various components such as cords, dials, handsets, and housing in colours which have been rated Manufacture Discontinued.

**1.02** This section is reissued to:

- Revise Table A.



Colour	Colour Code	Telephone Sets							Coin Collector Type 233	Keys Type		Speakerphone Components
		500 Type			600 Type	700 Type	QSK100AX	Coin		6040	6050	
		0-1	4-6	Wall	Call	Princess	Type	Type				
		Button	Button		Directors		Contempra	2236				
Black	3	•	•	•				•	•	•	•	
Warm White	20							•				
Deep Turquoise	21							•				
Mauve	22							•				
Bright Red	23							•				
Pale Yellow	24							•				
Deep Blue	25							•				
Ivory	50	•	•	•				•			⊙	•
Green	51	•	•	•	•			•	•		⊙	•
Red	53	•		•								
White	58	•		•							⊙	
Pink	59							•				
Light Beige	60	•	•	•	•	•	•	•	•		⊙	•
Grey	61	•	•	•	•						⊙	•
Aqua Blue	62	•		•				•				
Turquoise	64							•				

⊙ Coloured Covers are available.

TABLE A  
STANDARD COLOUR TELEPHONE APPARATUS

## HANDLING, PACKING AND RETURNING STATION SUPPLIES

### 1. GENERAL

1.01 This section gives instructions on how to handle, pack and return recovered or surplus material and tools to company storerooms.

1.02 Defective equipment shall be tagged with Form 2898. This applies to both unused and recovered material.

1.03 This section is reissued to replace Shock Resistant Wadding with Packing Resistant Shock and add Fig. 6.

### 2. REMOVAL AND DISMANTLING OF EQUIPMENT

2.01 Telephone equipment prior to removal from customer's premises, except in unusual cases, requires only a small amount of cleaning and testing to make it acceptable for re-installation. However, expensive repairs are often made necessary due to carelessness when removing or dismantling equipment.

2.02 Equipment shall not be pried or torn off poles, walls, desks, etc. Mounting cords or line cords shall not be cut or pulled from terminals. To avoid damage to property, the appropriate tools shall be used.

2.03 After the equipment has been disconnected and removed, backboards, screws, wire ends, etc., shall be removed from the equipment and items such as Key Telephone Units, cable terminals, binding post chambers, etc. shall have the cables disconnected and terminal post cleared before being returned. Tags and cards which indicate service history, etc., should not be removed.

2.04 Except when specific instructions have been given to the contrary, telephone equipment shall be returned to the work centre or

Telephone Distributing House in the same state of assembly as when it was supplied.

### 3. REUSE OF PACKING KITS

3.01 Packing Kits, surplus or recovered, such as corrugated telephone set cartons, Key Telephone Unit cartons, cases from new equipment and tools, etc., shall, when indicated by the letter "R" enclosed in a triangle, be returned to the storeroom.

### 4. PACKING EQUIPMENT AND MATERIAL

#### Unused Equipment and Material

4.01 Unused equipment, when returned from the customer's premises, shall be in the same state of assembly as when received and shall be returned in the original packing if possible. If the original packing is not available, other suitable containers may be used but all previous markings must be obliterated and the correct material designation must be marked on the container.

#### Recovered Equipment and Material

4.02 When returning recovered material and equipment, the material-using employee shall pack it as follows:

(1) *Automatic Telephone Answering Sets* -

Due to the complex mechanism of this equipment, it should be packed in an appropriate shipping case, which is available upon requisition, before returning.

(2) *Cold Cathode Tubes* - These tubes are gas-filled, containing a minute amount of radioactive material to ensure consistent operation. The material consists of a deposit of radium bromide on the inside of the glassen envelope. In addition, a quantity of slightly radioactive gas is formed in the tube. Tubes shall be individually wrapped with Packing Resistant Shock and the contents of the package identified on the label.

**Note:** These tubes are marked with a magenta (purplish red), three bladed propeller shaped symbol. The container will be marked appropriately to indicate the need for care in handling.



- (a) **Do not handle broken tubes if you have cuts or open sores on exposed surfaces of hands, arms or face. Rinse immediately, with lots of cold water, any cuts caused by broken tubes. See appropriate Bell System Practices sections for additional precautions**
- (3) **Distributing Frame Wire** - Wire in lengths of 10 feet or less, shall be baled or bagged, all types combined, and returned as junk. A scrap wire paper bag is obtainable on requisition for this purpose.
- (4) **Drop Wire** -
- (a) All types of unused drop wire over 50 ft. shall be used by the craftsman and not returned to the storeroom.
- (b) Recovered N.E. and N.C. Drop Wire and unused short lengths not economically suited for use shall be returned to the local storeroom for disposition. Storerooms shall dispose of the wire locally, if there are facilities for so doing, without adversely affecting public opinion. When local facilities are not available, wire shall be returned to the Telephone Distribution House for disposal.
- (c) Recovered H.D. Drop Wire shall be returned to the local storeroom for return to the Telephone Distribution House.
- (5) **Inside Wiring Cable and Connector Cables** - These cables should be tagged and coiled as to size and length.
- (6) **Installer's and B Repairman's Cases** - The combination locks on these cases shall be reset at "000" before returning.
- (7) **Keys, Handsets, Subsets, Speakerphones** - Components and similar apparatus items shall be returned in individual No. 1 Polyethylene Bags to protect the finish. If better protection is required, a standard telephone carton shall also be used.
- (8) **Key Telephone Units** - When practical, the units shall be returned, assembled in the 105 Apparatus Box or Equipment Cabinet in which they were installed. When the units are loose, maximum protection shall be given by the use of Packing Kits or *if the kits are unavailable, by cushioning with Packing Resistant Shock and crumpled paper in suitable cartons or containers. See Fig. 6.*
- (9) **PBX Battery Units and Used Storage Batteries** - The acid solution shall not be emptied from these batteries before shipping. Recovered batteries shall be returned in special battery cases. Where possible, storage batteries may be disposed of locally; however, this shall be done by Supplies personnel only.
- (10) **Radiotelephone Equipment** - This equipment shall be carefully packed, using Packing Resistant Shock. See Fig. 6.
- (11) **Sharp Tools** - and other hazardous items shall be protected with guards or other suitable protection.
- (12) **Small Parts** - Dials, ringers, transmitter or receiver units, and similar replacement parts, shall, when possible, be returned in the carton in which the new parts were received.
- (13) **Switchboards, Teletypewriters and Teletypewriter Tables** - Whenever possible this equipment should be packed in the appropriate packing case which is available upon request, before it is removed from the customer's premises. However, if the carter (either company operated or contractor) is able to supply adequate protection (quilted blankets, etc.) it will not be necessary to pack switchboards (other than the 507 Type). The ribbon and inking devices shall be removed from teletypewriters before packing.
- (14) **Telephone Sets** - are to be secured as shown in Fig. 1 to 5.

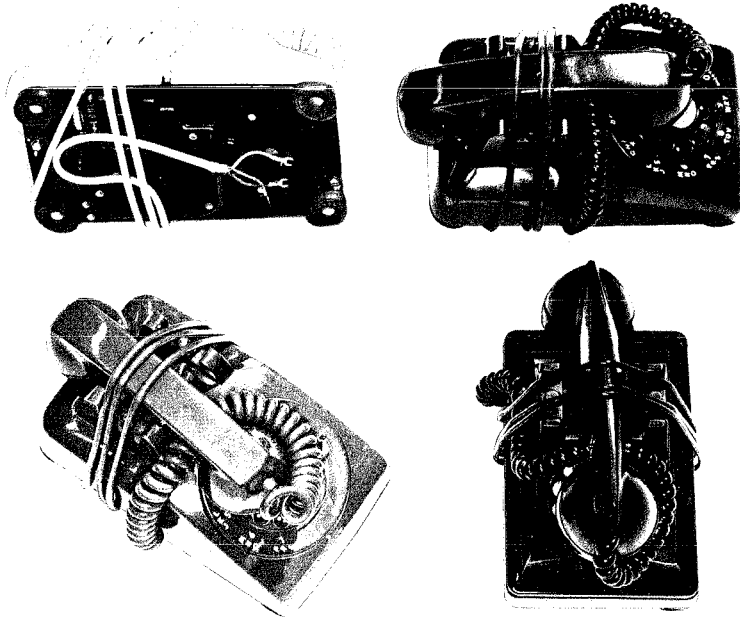


Fig. 1 — Desk Set Prepared for Packing

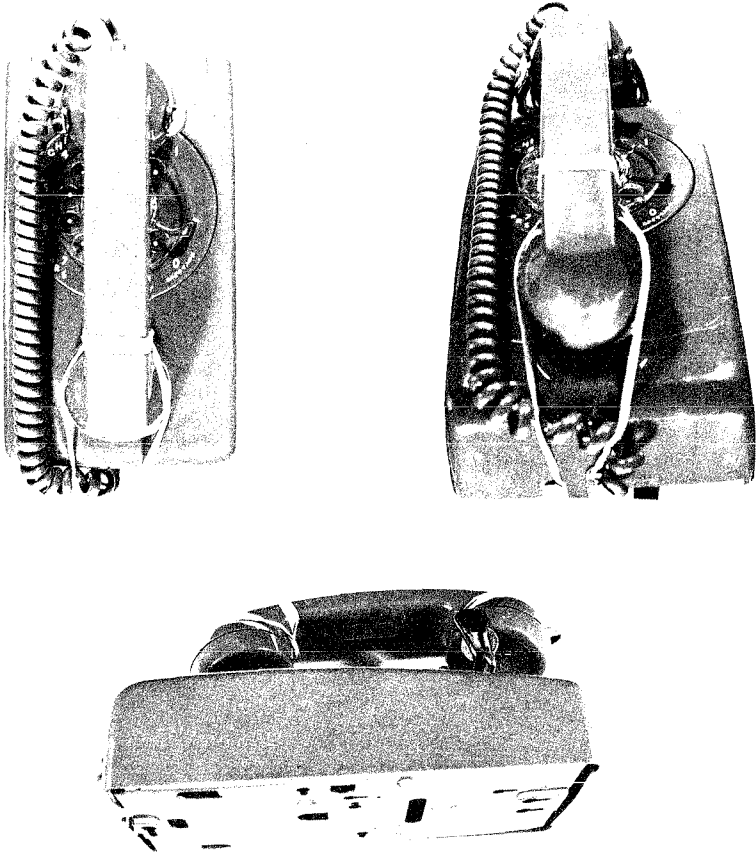


Fig. 2 — Wall Set Prepared for Packing

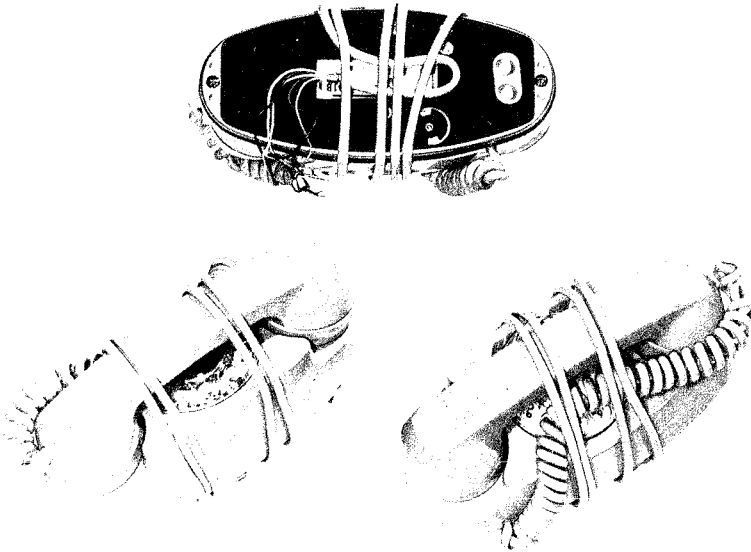


Fig. 3 — Princess Set Prepared for Packing

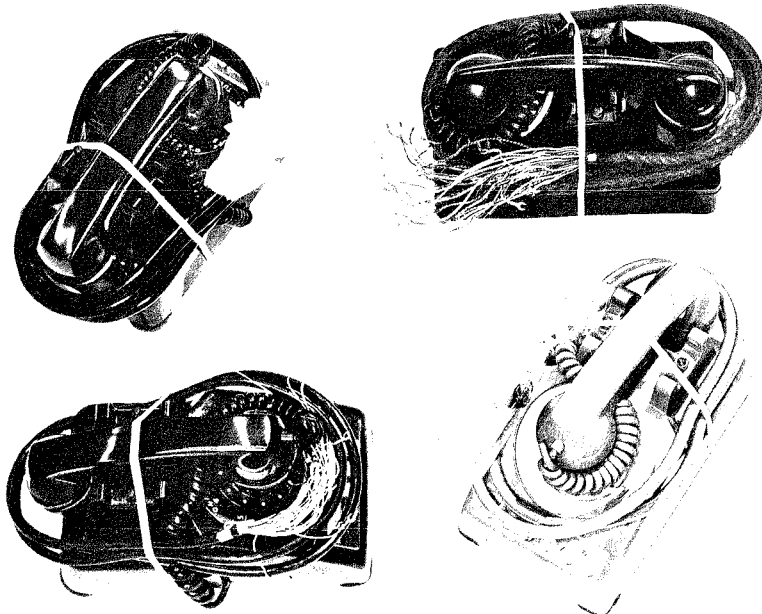
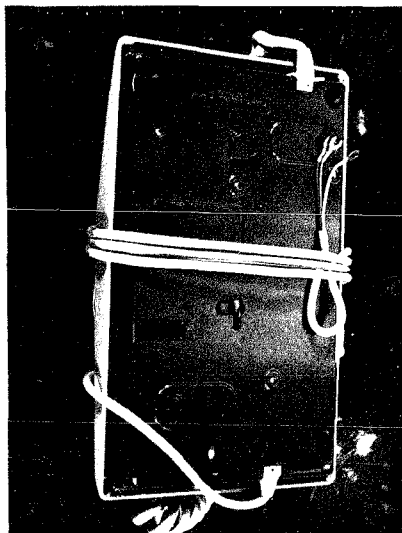
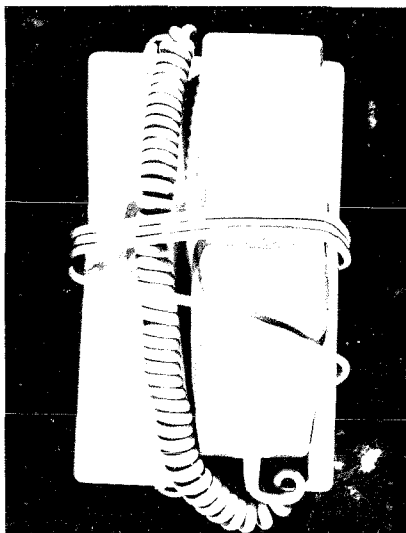


Fig. 4 — Multi-Button Set Prepared for Packing

Desk



Wall

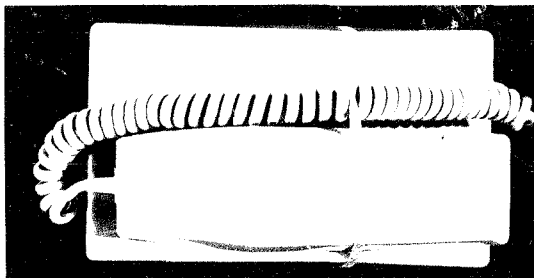


Fig. 5 — Contempra Sets — Desk and Wall Prepared for Packing

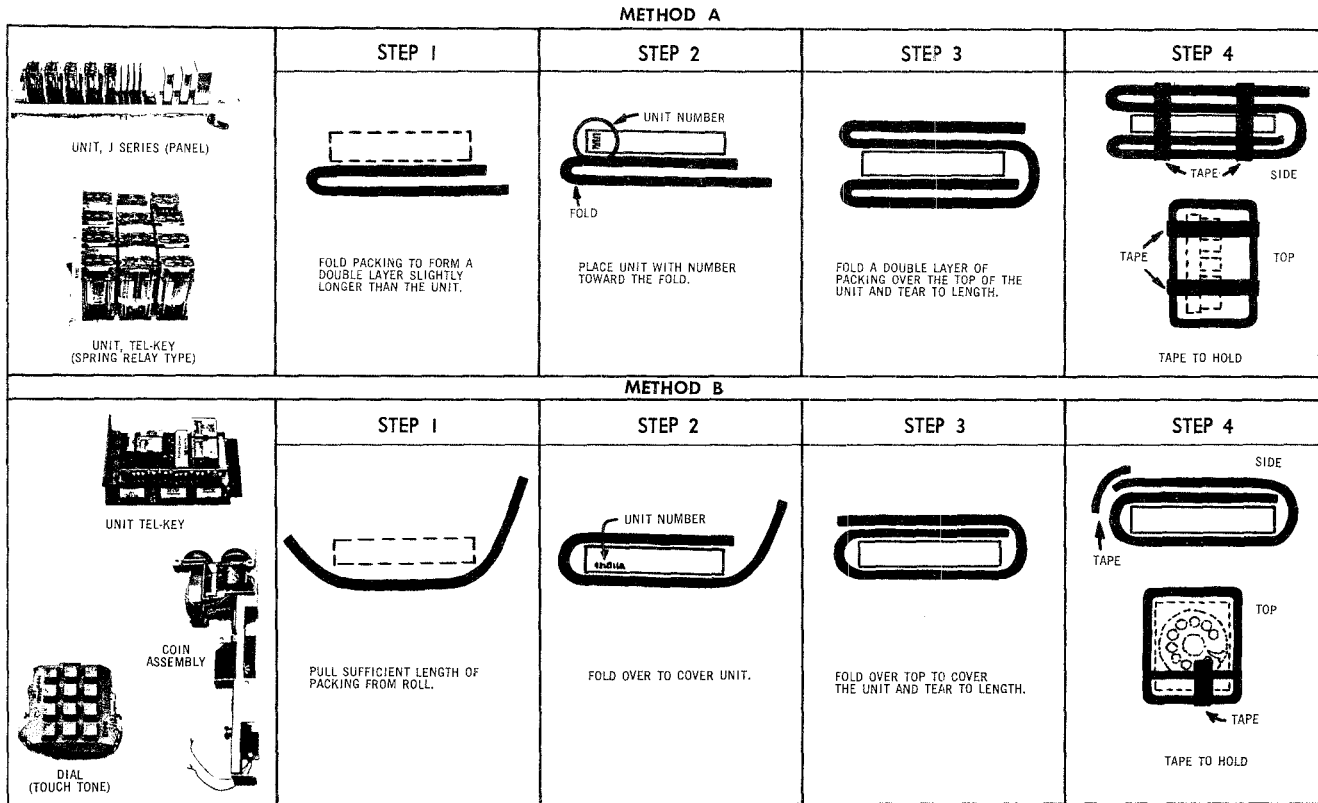


Fig. 6 — Procedures to be Used When Packing with Packing Resistant Shock

- Note 1:** Identify item (or item with same approximate size & weight) and locate on chart.
- 2:** Follow method as shown to obtain required protection and ease of identification.
- 3:** Place wrapped item in hamper or appropriate box on vehicle.





## STATION DIALS 9-TYPE IDENTIFICATION AND MAINTENANCE

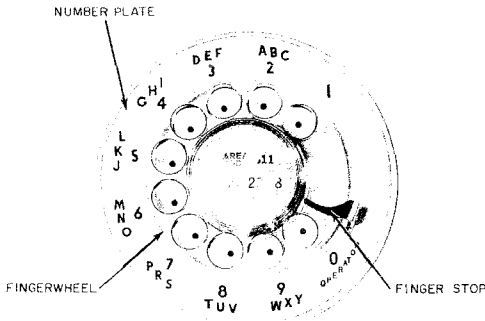


Fig. 1 — 9-Type Dial, Front View

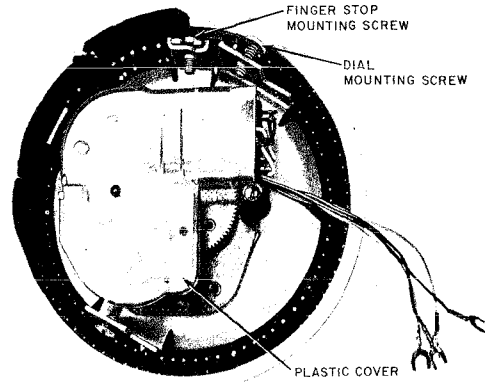


Fig. 2 — 9-Type Dial, Rear View

### 1. GENERAL

1.01 This section is reissued to:

- Revise illustrations
- Revise text

### 2. PURPOSE

To provide a direct replacement for 7-type dials.

### 3. ORDERING GUIDE

- Refer to Table A for components

TABLE A\*  
COMPONENT ORDERING GUIDE

REPLACEABLE COMPONENTS	DIAL						
	9C	9H	9K	9L	9M	9N	9P
Cover, Plastic	P-11E300	P-11E300	P-11E300	P-11E300	P-11E300	P-21F157	P-11E300
Plate, Clamp	P-44E348	P-44E348	P-44E348	P-44E348	P-44E348	P-44E348	P-44E348
Plate, Number	P-82D400†	P-82D400†	P-82D500†	P-82D600†	P-82D400†	P-83D400†	P-82D400†
Stop, Finger	P-44E351	P-44E351	P-44E351	P-44E351	P-44E351	P-44E351	P-44E351
Wheel, Finger	P-11E007	P-11E007	P-11E007	P-11E007	P-11E007	P-11E007	P-11E007

\*Refer to Table B for color selection.

†Add suffix for desired color.

**SECTION 501-162-101**

**4. COLOR**

**TABLE B  
COLOR ORDERING GUIDE\***

COLOR	DIAL						
	9C-	9H-	9K-	9L-	9M-	9N-	9P-
Black —03	•	•	•	•	•	•	•
Ivory —50	•	•					
Moss Green —51	•	•					
Red —53	•	•					
Pastel Yellow —56	•	•					
White —58	•	•	•			•	
Rose Pink —59	•	•					
Lt. Beige —60	•	•					
Lt. Gray —61	•	•				•	
Aqua Blue —62	•	•					
Turquoise —64	•	•					

\*Refer to Section 500-120-100 for promoted colors.

**5. APPLICATION**

**TABLE C**

DIAL	SCHEMATIC FIG.	PULSES PER SECOND	REPLACES	USE
9C	3A	10	7A, 7C, 7D	General station sets. With colored sets or illuminated dial sets designed for 2-post mounting.
9H	3B	10	7E, 7G, 7H	Has two pair of off-normal contacts designed for speaker-phone systems. Also used on 532-, 533-, 535-, and 536-type telephone sets.
9K	3B	10	7K	Modular telephone panels
9L	3B	10	7L	Data set 101A. 691A subscriber set.
9M	3A	10	—	525-type telephone sets.
9N	3B	10	—	568N telephone set. 817A1 data auxiliary set.
9P	3C	10	—	529B telephone set.

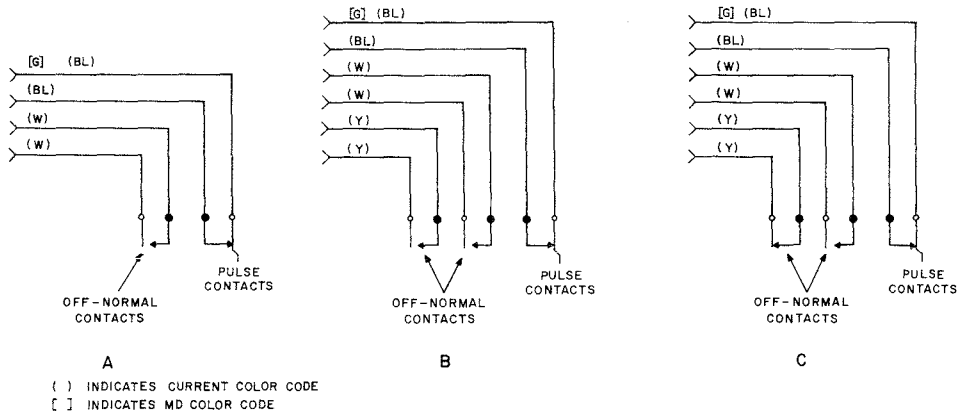


Fig. 3 — Dial Contact Schematics

## 6. MAINTENANCE

(a) Replaceable Apparatus (Refer to Identification Section for ordering guide and color)

- Finger Stop
- Fingerwheel
- Number Plate
- Plastic Cover

(b) Parts of the dial shall not be broken or missing.

(c) The finger stop shall not be loose or damaged.

- With the dial in its unoperated position, the finger stop shall not overlap the "0" hole by more than 1/32-inch.

(d) The dial shall operate smoothly without slipping or skipping.

(1) Check by operating dial several times.

- Replace dial if it fails in this requirement or is suspected of giving wrong numbers.

- Replace dial if improper dial speed or gear mesh is suspected.

(e) Do not lubricate any part of the dial.

(f) Exterior parts of the dial should be wiped with a dry KS-2423 cloth.

(g) Clean number plate with a damp KS-2423 cloth.

- If number plate cannot be cleaned or is marred or chipped, replace (see 6.03).

### PLASTIC FINGERWHEEL

6.01 To remove fingerwheel:

(1) Rotate fingerwheel as far as possible in clockwise direction.

(2) Insert KS-16750, List 2 releaser into small hole located in edge of raised center of fingerwheel (Fig. 4) and push down to disengage the fingerwheel clamp spring.

(3) When clamp spring releases, remove fingerwheel.

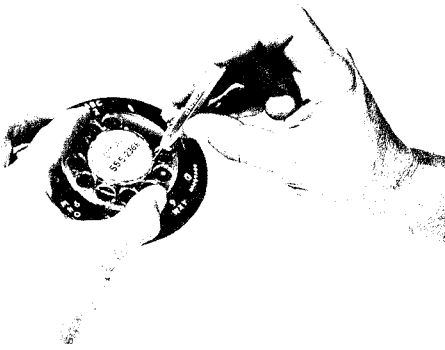


Fig. 4— Removing Plastic Fingerwheel

**6.02 To replace fingerwheel:**

- (1) Place fingerwheel over clamp with "0" hole directly over digit 9, making sure fingerwheel depressions are properly positioned on prongs of clamp plate.
- (2) Rotate fingerwheel in counterclockwise direction until clamp spring snaps into notch on underside of fingerwheel (Fig. 5).

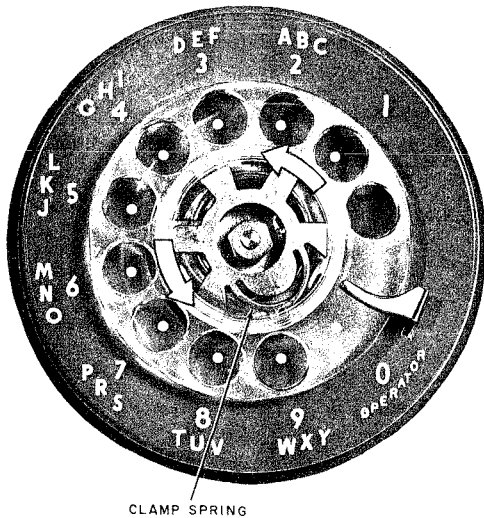


Fig. 5— Replacing Plastic Fingerwheel

**NUMBER PLATE**

**6.03 To remove number plate:**

- (1) Remove fingerwheel (see 6.01).
- (2) Remove finger stop by loosening finger stop mounting screw.

**THINK** Exercise caution to prevent screwdriver from slipping and damaging clamp plate assembly.

- (3) Insert tip of screwdriver blade into one of the three slots on the lock ring (Fig. 6).

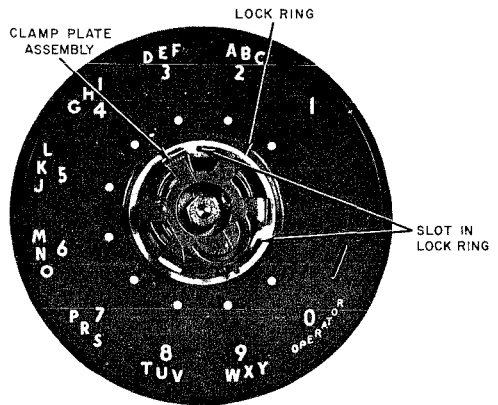


Fig. 6— Fingerwheel and Finger Stop Removed to Show Lock Ring

- (4) Rotate lock ring as shown in Fig. 7 until it is free.
- (5) Raise lock ring until it is just under the clamp plate and slide toward the numeral 4 until the upper end of the ring can be lifted over the clamp plate (Fig. 8). Slide ring toward numeral 9 to remove.
- (6) Lift off number plate.

**6.04 To replace number plate:**

- (1) Reverse procedures in 6.03.

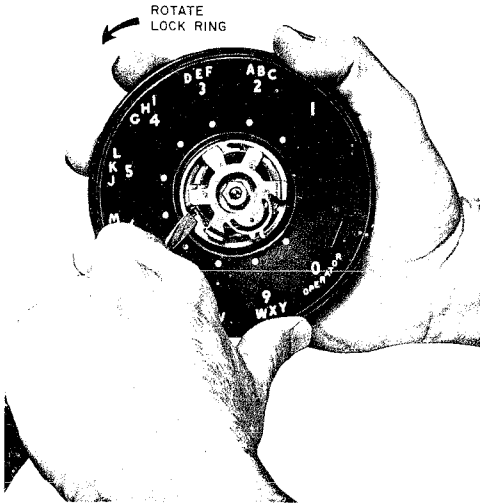


Fig. 7 — Lock Ring Removal

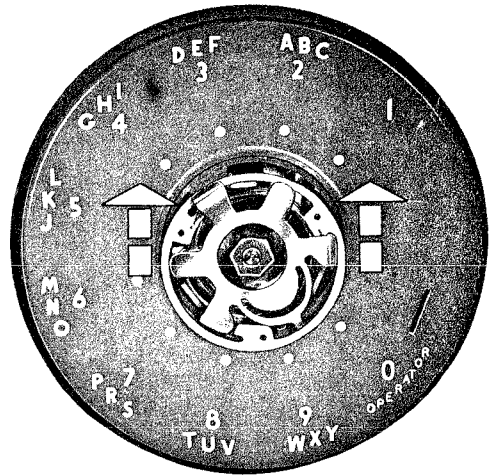


Fig. 8 — Lock Ring in Extreme Forward Position for Removal



## STATION DIALS

### QDB-TYPE

#### IDENTIFICATION AND MAINTENANCE

##### 1. GENERAL

1.01 This section covers the identification and maintenance of the QDB1A and QDB1B dials.

##### 2. DESCRIPTION

2.01 The QDB-type dial (Fig. 1 and 2) is a direct replacement for the No. 7-type dial.

2.02 Except for the fingerwheel, none of the replaceable parts of the QDB-type dial are interchangeable with the No. 7-type.

2.03 The new fingerwheel introduces two new features:

(1) A longer, more prominent tab, which will assist in locating the station number card correctly.

(2) A small hole, between finger holes 3 and 4, is provided to assist in the removal of the station number card.

2.04 Plastic bearing, reoriented governor studs and a relocated governor cup are incorporated into the design of the QDB-type dial. These features combine to make the operation smoother and more quiet than that of the No. 7-type dial.

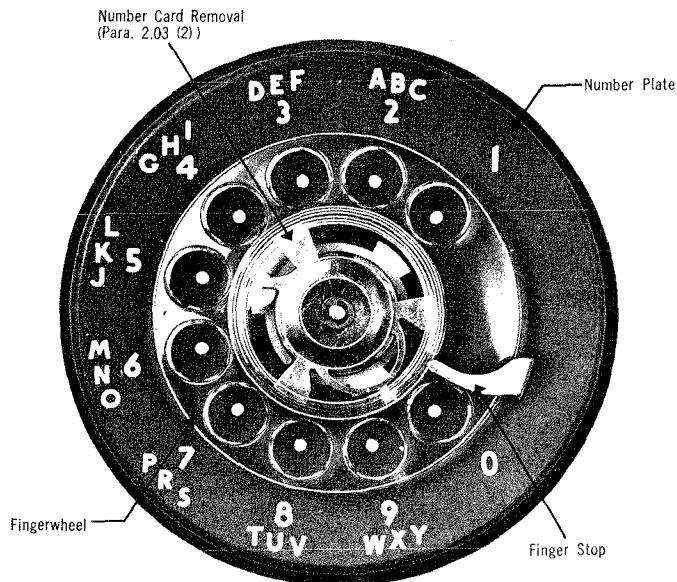


Fig. 1 — QDB-Type Dial — Front View



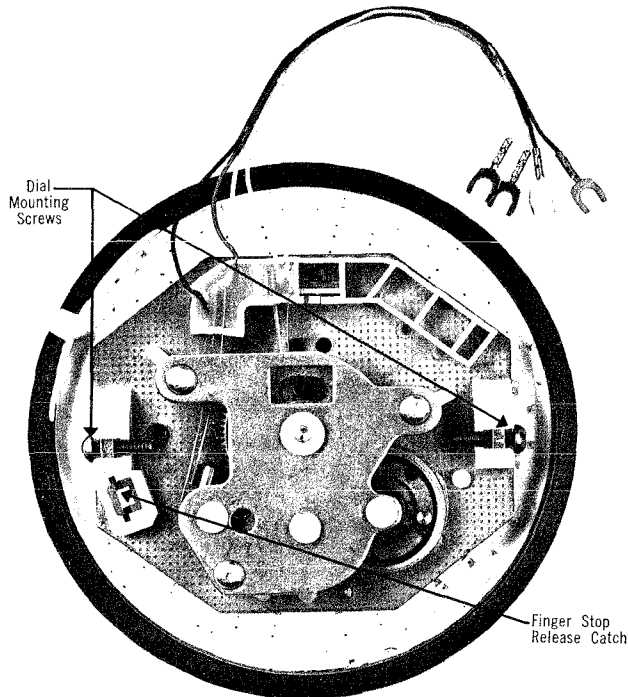


Fig. 2 — QDB-Type Dial — Rear View

## 3. APPLICATION

TABLE A  
USES OF QDB-TYPE DIAL

Dial	Replaces 7-Type	Schematic Fig.	Uses
QDB1A	7C and D	3A	General station. With coloured sets or illuminated dial sets designed for 2-post mounting.
QDB1B	7G and H	4B	Has two pair off-normal contacts. Designed for speakerphone and 1A, 1A1 and 1A2 key telephone systems. Also used on 532-, 535- and 536-type telephone sets.

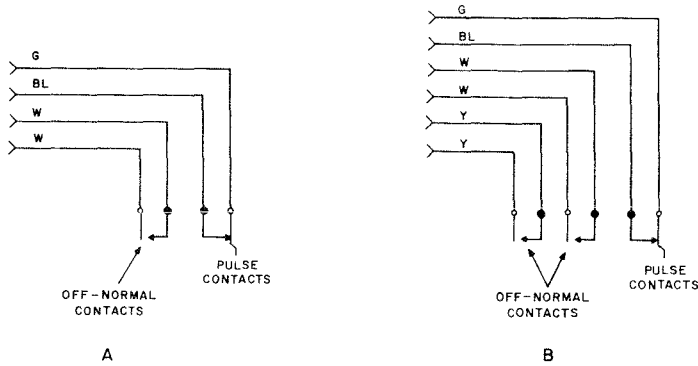


Fig. 3 - Dial Contact Schematics

4. MAINTENANCE

(a) Replaceable apparatus. (See Fig. 4)

- Finger Stop — P97M988
- Fingerwheel — P97M849
- Number Plate — P96A700 (and colour code)
- Dial Mechanism: QDB1A — P894297  
QDB1B — P894298

(b) Parts of dial shall not be broken or missing.

(c) The finger stop shall not be loose or damaged.

(d) The dial shall operate smoothly without slipping or skipping.

(1) Check by operating dial several times.

- Replace the dial mechanism if it fails to meet this requirement or is suspected of giving wrong numbers.
- Replace the dial mechanism if improper dial speed or gear mesh is suspected.

(e) Do not lubricate any part of this dial.

(f) Do not attempt to adjust the dial speed or percent break of this dial.

(g) Do not lift or carry this dial by the dial contact leads.

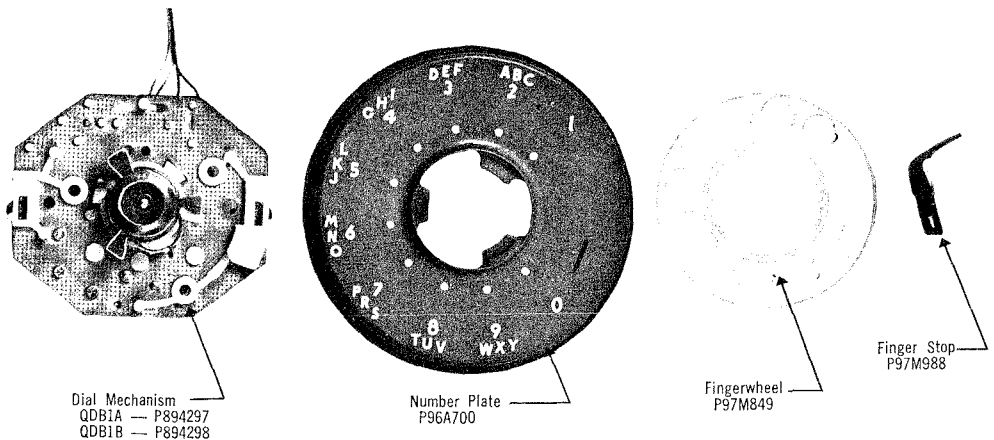


Fig. 4 - Assembly of Parts

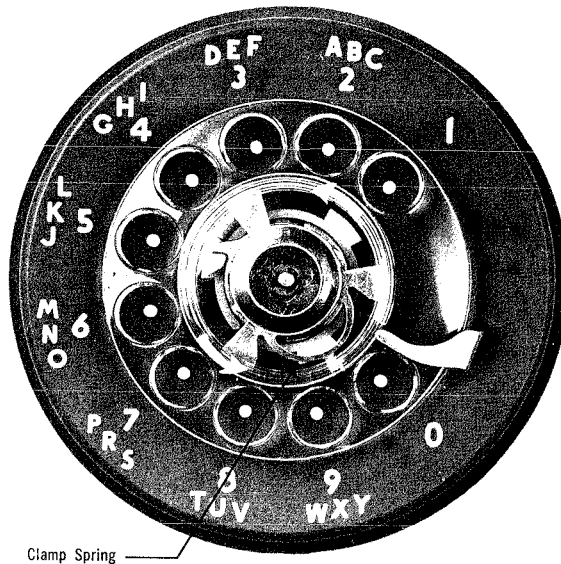
**Plastic Fingerwheel**

**4.01 To remove fingerwheel:**

- (1) Rotate fingerwheel as far as possible in a clockwise direction.
- (2) Insert KS-16750, List 2 dial tool into the small hole located in the edge of the serrated section of the fingerwheel and push down to disengage the fingerwheel clamp spring.
- (3) When clamp spring releases, remove fingerwheel and dial will return to normal.

**4.02 To replace fingerwheel (see Fig. 5):**

- (1) Place fingerwheel over clamp with the "0" hole directly over the digit "9" making sure that the fingerwheel depressions are properly positioned on the tangs of the clamp plate.
- (2) Rotate fingerwheel in a counterclockwise direction until clamp spring snaps into the notch on the underside of the fingerwheel.

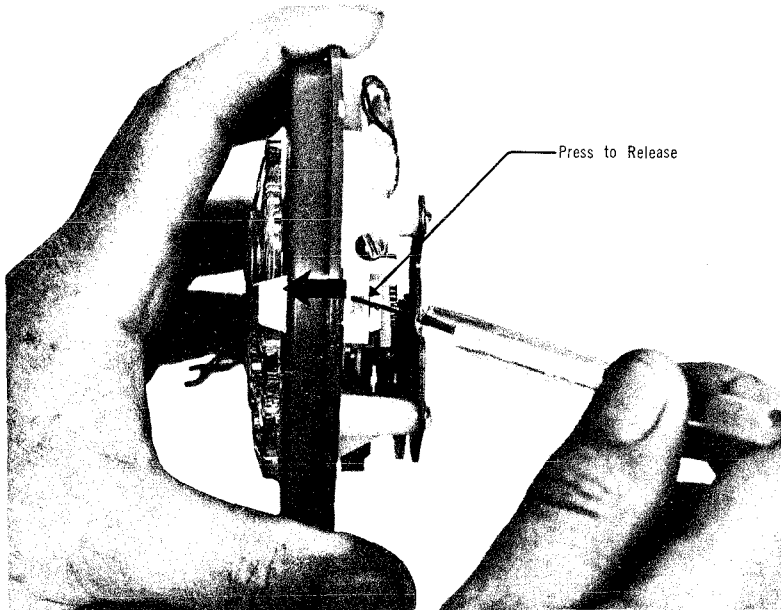


**Fig. 5 — Replacing Fingerwheel**

**Finger Stop**

**4.03** To remove finger stop (see Fig. 6):

- (1) Depress plastic locking tab with KS-16750, List 2 dial release tool.
- (2) With locking tab depressed, pull the finger stop outwards until fully disengaged.



**Fig. 6 – Removal of Finger Stop**

**Number Plate**

**4.04** To remove number plate:

- (1) Remove fingerwheel (see Para. 4.01).
- (2) Remove finger stop (see Para. 4.03).
- (3) Remove number plate by rotating it in a counterclockwise direction until it becomes free (see Fig. 7).
- (4) Raise the top portion of the number plate until it clears the clamp plate.
- (5) Lift number plate off the dial mechanism.

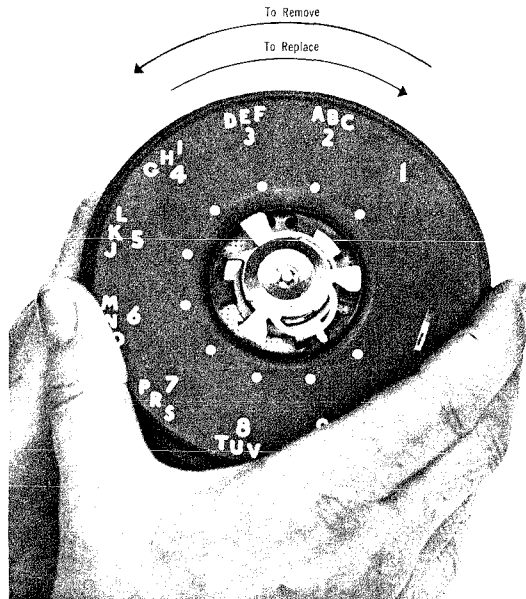


Fig. 7 — Removal of Number Plate

**4.05** Reassembly procedure:

(1) Place number plate directly over the dial mechanism and twist the number plate in a clockwise direction as far as possible. During the reassembly procedure, the dial leads must be located at the top of the dial number plate.

(2) Place the finger stop through the opening in the number plate and into the dial mechanism. A distinct click will be heard when the finger stop is fully engaged.

(3) Place fingerwheel in a normal manner.

## STATION DIALS

### 25-TYPE

### IDENTIFICATION AND MAINTENANCE

#### 1. GENERAL

1.01 This section is reissued to revise the illustrations and to make associated changes in the text.

1.02 Due to extensive changes, marginal arrows have been omitted.

#### 2. IDENTIFICATION

2.01 The 25-type TOUCH-TONE dial is a 10-button multifrequency dialing device. It is equipped with pushbuttons having numbers and letters (Fig. 1). It has a transistorized oscillator, printed circuit board, frequency contacts, and a common switch.

2.02 The transistorized oscillator generates the customer dialing signals and is powered by current from the telephone line.

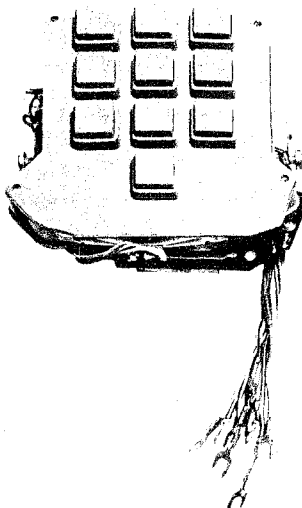


Fig. 1 — 25-Type Dial, Front View

SECTION 501-164-105CA

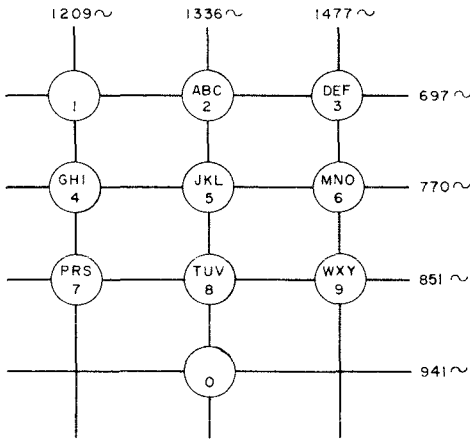


Fig. 2 — Dial Frequencies

2.03 Any pushbutton depressed will close one low band and one high band frequency contact. These contacts close a path for 2 of the 7 output frequencies of the oscillator. (Fig. 2).

2.04 Continued travel of the button will operate the common switch (Fig. 3). Each button operates a different pair of frequency contacts. All buttons operate the common switch. The signal will remain on the line as long as the button is depressed. For example: when button number 5 is depressed, it selects frequencies of 770 and 1336 cycles simultaneously for transmission to the central office.

2.05 The common switch (Fig. 3), when operated, reduces the sidetone to the receiver, opens the transmitter path, applies bias voltage to the transistorized oscillator, and breaks the dc energy path to the tank coils.

2.06 The central office must be equipped with a converter that will accept the oscillator signals and translate them into a 2-out-of-5 digit code for cross-bar offices or dial pulses for step-by-step offices. The converter in the central office does not interfere with rotary dial pulse signals. Both TOUCH-TONE and rotary dial type sets may be served by the same central office equipment.

TABLE A

DIALS

DIAL NUMBER	PUSHBUTTON CHARACTERS	USES	REMARKS	FIG. NO.
25A3	Letters and Numbers	General purpose; in desk, wall, and panel mounted telephone sets	Has standard common switch. Cannot be used with 3A speakerphone.	1.3 & 6
25B3		In telephone sets for 3A speakerphone systems	Similar to 25A3 dial but has an expanded common switch and additional leads.	4
25E3		In coin telephone	Similar to 25A3 dial but has modified circuit for use with coin telephones.	8
25H4		For use in PRINCESS sets	Dial light illuminates the pushbuttons by means of a clear plastic light guide mounted within the dial.	5 & 6

Dials are available in grey only.

### 3. MAINTENANCE



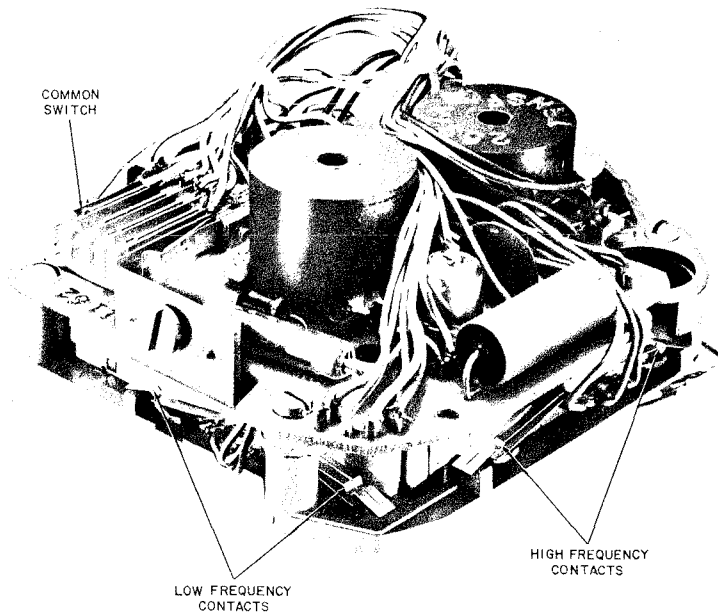
*Maintenance of 25-type dial consists only of determining if the dial is defective. Do not attempt adjustments of the dial in the field.*

**Note:** Check polarity of dial before testing to determine if dial is defective.

- 3.01** The 25-type dial will function only when the O-BK dial lead is connected to the ring (− negative) side of the line and the G dial lead is connected to the tip (+ positive) side of the line.
- 3.02** Use the following methods to determine if the dial is defective:
- (1) Check for presence of dial tone. If no dial tone is heard, make a check with the 1011 test set at the connecting block. If dial tone is heard at the connecting block, make

normal test of telephone set components as described in appropriate sections.

- (2) Break dial tone by dialing digit 2. If unable to break dial tone, restore switch hook to normal and connect 1011 test set across incoming line terminations of network. Dial a digit to break dial tone. If dial tone can be broken at the network, replace the dial.
- (3) Check all buttons for tone feedback. When any button is depressed, two tones should be heard. These tones are blended together but can be identified as two tones. When any two adjacent buttons are depressed simultaneously, only one tone should be heard.
- (4) Replace dial if feedback tones are not as described.
- (5) Dial the station ringer test circuit for test of TOUCH-TONE dials. Refer to Section 951-920-100 for details.



**Fig. 3 — 25-Type Dial, Rear View**



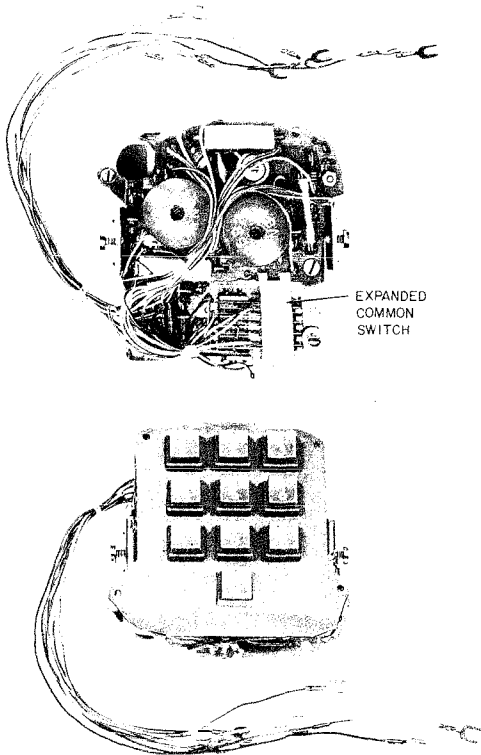


Fig. 4 — 25B3 Dial

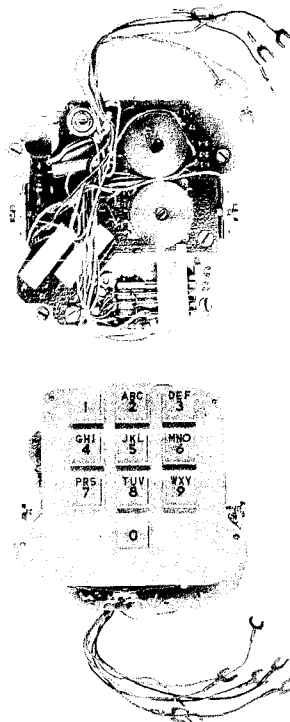


Fig. 5 — 25H4 Dial

3.03 If telephone set meets requirements in Part 3 and trouble still exists, check the central office or PBX equipment.

#### 4. SCHEMATIC INDEX

Fig. 6 — 25A and H Dials

Fig. 7 — 25B Dial

Fig. 8 — 25E Dial

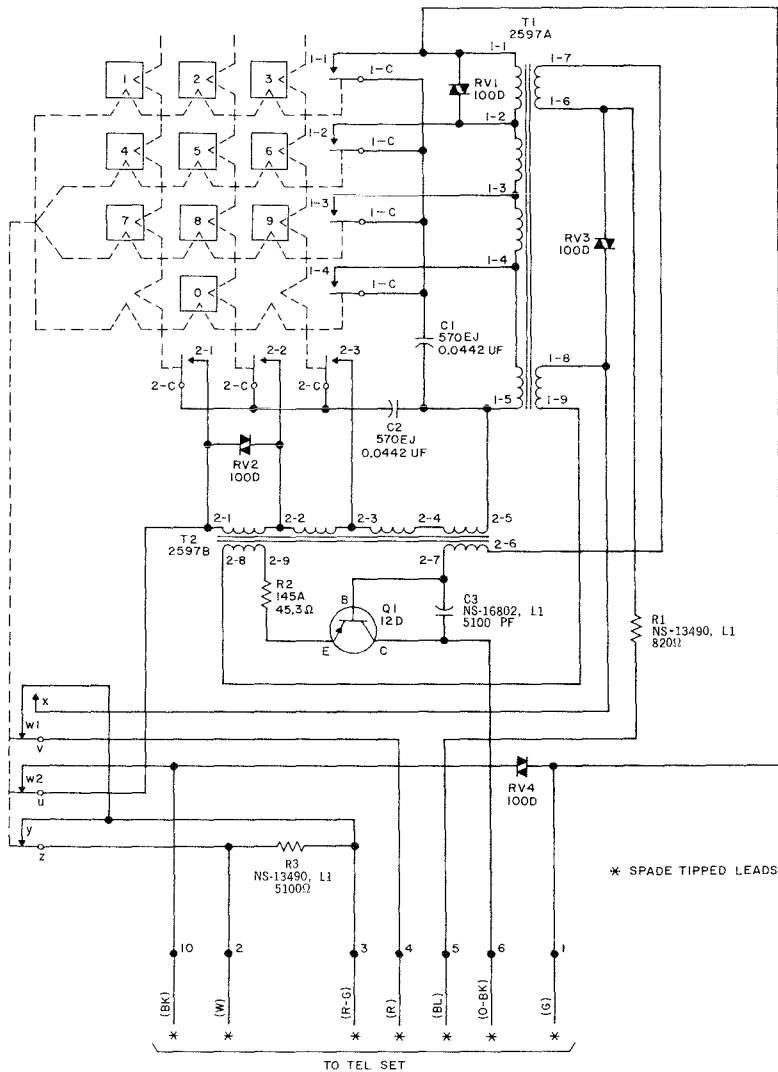


Fig. 6 -- 25A and H Dials

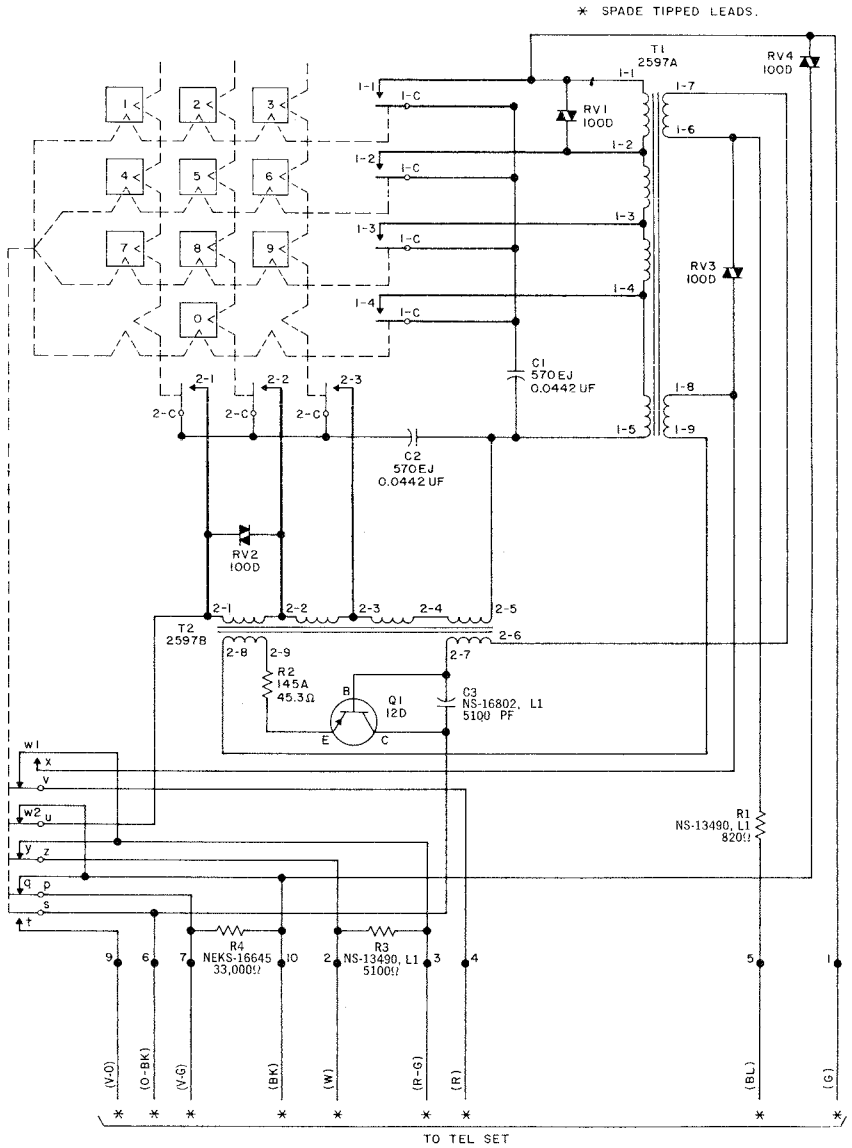


Fig. 7 - 25B Dial

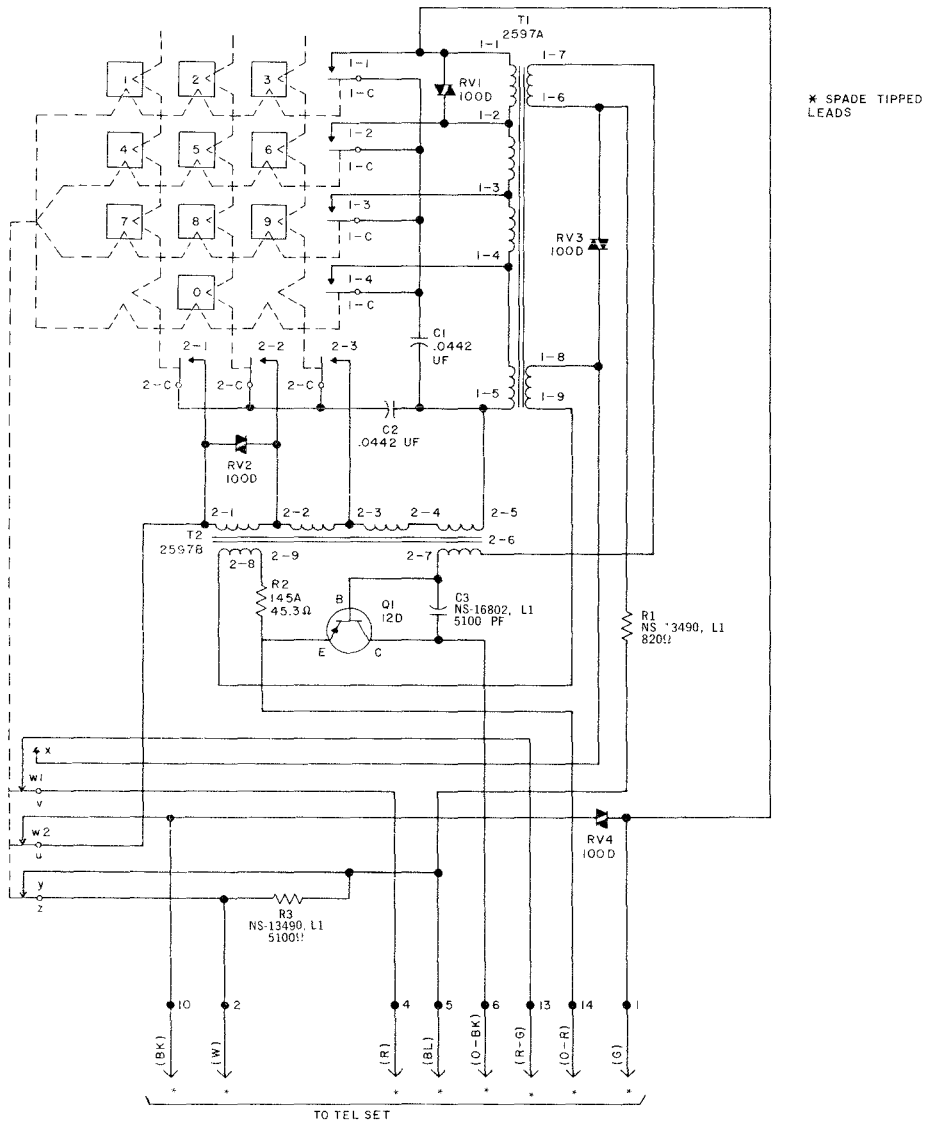


Fig. 8 -- 25E Dial



## STATION DIALS

### 35-TYPE

#### IDENTIFICATION AND MAINTENANCE

##### 1. GENERAL

1.01 This section provides information on 35 type dials.

1.02 This section is reissued to add information on the 35Q3J Dial.

1.03 The 35-type dials (Fig. 1 and 2) are TOUCH-TONE® dials having twelve push-buttons. Ten are used in "number-letter" calling and two are used to give special service connections.

1.04 The twelve pushbuttons, switches, and multifrequency oscillator are a unit. It is mounted in a manner similar to a rotary dial.

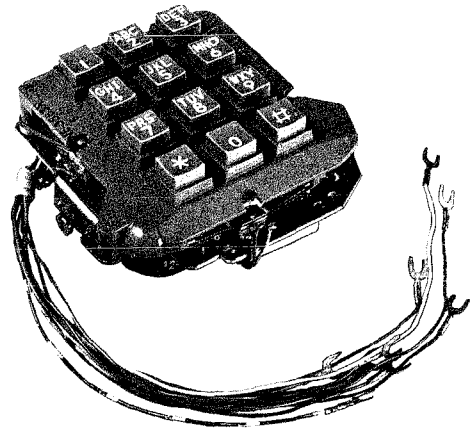


Fig. 1 — 35-Type Dial — Front View

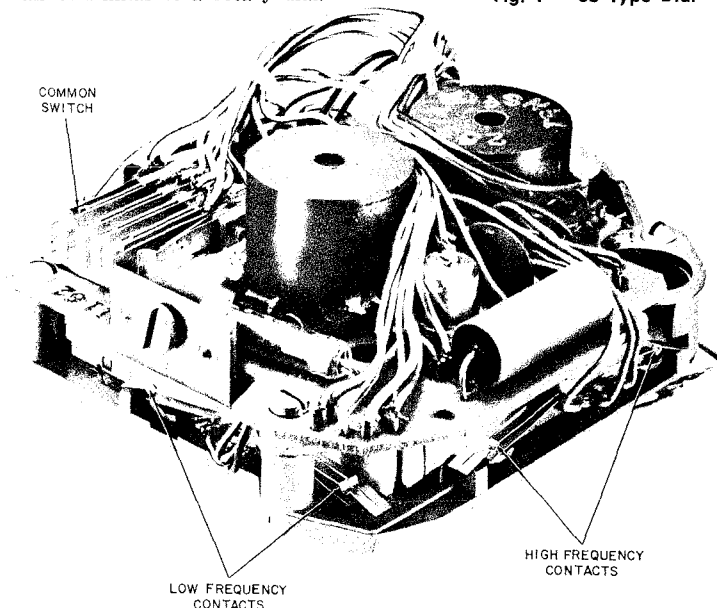
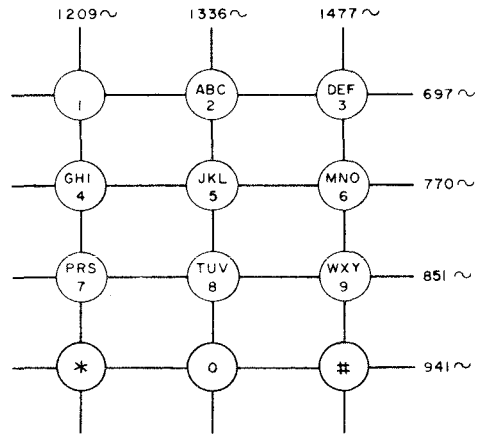


Fig. 2 — 35-Type Dial — Rear View

**SECTION 501-164-115CA**

**1.05** The transistorized oscillator generates the customer dialing signals and is powered by current from the telephone line.

**1.06** Each pushbutton operates a different pair of frequency contacts which closes a path for 2 of the 7 output frequencies of the dial (Fig. 3). All pushbuttons operate the common switch which reduces side tone to the receiver, opens the transmitter path, applies bias voltage to the transistorized oscillator, and breaks the DC path to the tank coils.



**Fig. 3 – Dial Frequencies**

**2. IDENTIFICATION**

**2.01** Table A lists the 35-type dials and describes their uses.

**TABLE A  
DIALS**

Dial Number	Pushbutton Characters	Uses	Remarks	Fig. No.
35A3 35Q3A*	See Fig. 1	General purpose; in desk, wall, and panel mounted telephone sets	Has general purpose common switch. Cannot be used with 3A speakerphone.	4 4A
35B3 35Q3B*		In telephone sets for 3A speakerphone systems and in the 1035B3QA dial	Has an expanded common switch and wiring consistent with use.	5 5A
35E3 35Q3E*		In coin telephones	Similar to 35A3 dial but has modified circuit for use with coin telephones.	6 6A
35J3 35Q3D*		In 1- and 2-type consoles	Has an expanded common switch and wiring consistent with use.	7 7A
35B3QA 35Q3C*		Business Interphone	Has an expanded common switch and wiring consistent with use.	8 8A
35Q3J		Multicom Medium Speed Service	Has an expanded common switch and wiring consistent with use.	9

Dials are available in grey only.

\*Have no Black or Green leads. Refer to Part 5 for set wiring changes and connection information.

### 3. MAINTENANCE



*Maintenance for the 35-type dial consists only of determining if the dial is defective. Do not attempt adjustments of the dial in the field.*

**3.01** To maintain proper dial polarity, refer to sections containing connections for the telephone sets of which this dial is a component.

**3.02** The 35-type dial must be poled properly. It will function only when the (O-BK) dial lead is connected to the ring (- negative) side of the circuit and the (OR) dial lead is connected to the tip (+ positive) side of the circuit.

**3.03** If unable to dial, proceed as follows:

(1) Check wiring for secure and correct connections. See Part 5 for changes to set wiring when using new type dials.

(2) Check for presence of dial tone. If no dial tone is heard, check with 1011-type test set at connecting block. Make normal tests of telephone components as described in appropriate sections.

(3) Check all buttons for tone feedback. Two tones should be heard in the receiver when any button is depressed. These tones are blended together, but can be separately identified. When any two adjacent buttons are depressed simultaneously, only one tone should be heard. If feedback tones are not as described, replace dial.

**3.04** To test dial frequency and amplitude outputs, dial the station ringer test circuit provided for TOUCH-TONE dials. Refer to Section 951-920-100 for details.

**3.05** If dial meets requirements of 3.03 and 3.04 and trouble still exists, check Central Office or PBX equipment.

### 4. SCHEMATICS

Fig. 4 — 35A3-Type Dial

Fig. 4A — 35Q3A-Type Dial

Fig. 5 — 35B3-Type Dial

Fig. 5A — 35Q3B-Type Dial

Fig. 6 — 35E3-Type Dial

Fig. 6A — 35Q3E-Type Dial

Fig. 7 — 35J3-Type Dial

Fig. 7A — 35Q3D-Type Dial

Fig. 8 — 35B3QA-Type Dial

Fig. 8A — 35Q3C-Type Dial

Fig. 9 — 35Q3J-Type Dial

### 5. CONNECTION INFORMATION 35Q TYPE DIALS

**5.01** To replace existing 25 and 35 Type dials with the new 35Q Type dial proceed as follows:

**Note:** 35Q Type Dials have no black or green leads.

(a) **1500DQ1A, 1554BQ1A, 2500DQ1A and 2554BQ1A Telephone Sets**

Connect the O-BK, R, W, and R-G leads to the same locations as the existing dial. Move the S-W switchhook lead from F to RR on the network.

(b) **1511 and 2511 Telephone Sets**

Connect the O-BK, V-W, V-G, R, R-G and W leads to the same locations as the existing dial. Move the S-G 631A key lead from L1 to RR on the network.

(c) **1558DR & 2558DR Telephone Sets**

Connect the R-G, W, R, and O-BK leads to the same locations as the existing dial. Move the S-G pick-up key lead from F to RR on the network.

(d) **1565 and 2565 Type Telephone Sets**  
(other than those listed below)

Connect the O-BK, V-W, V-G, R, R-G and W leads to the same locations as the existing dial. The G lead of the 636A Key should be moved from L2 to RR on the network.



(e) **1565Q1B and 2565Q1B Telephone Sets**

Connect the BL-BK, V-G, V-W, R, W, R-GN, O-BK, and S leads to the same locations as the existing dial. The S-W switchhook lead should be moved from F to RR on the network.

(f) **2565LQF and LQE Telephone Sets**

Connect the V-G, O-BK, R-G, R, W, and V-W leads to the same locations as the existing dial. Move the G pick-up key lead from F to RR on the network.

(g) **1630 and 1631 Type, 2630 and 2631 Type Telephone Sets**

Connect the W, R-G, R, V-G, V-W and O-BK leads to the same locations as the existing dial. Move the V-BL mounting cord lead from terminal 4 on the terminal strip to RR on the network.

(h) **1634 and 1635 Type, 2634 and 2635 Type Telephone Sets**

Connect the W, R-G, R, V-G, V-W and O-BK leads to the same location as the existing dial. Move the W-BL mounting cord lead from

terminal 4 on the terminal strip to RR on the network.

(i) **1 & 2, QCN 3 & 4 Type Consoles**

Connect the W, R-G, R, BL-BK, O, G-W, V-BL and O-BK leads to the same location as the existing dial. Connect a jumper between terminals 1 and 7 of the dial assembly terminal strip.

(j) **1236 and 2236 QAS Coin Telephones**

Connect the BL, W, R, R-G, O-BK and O-R leads to the same location as the existing dial. Connect a jumper between C on the network and 6 on the terminal strip.

(k) **2565QHA Telephone Set**

Connect dial leads as follows:

R-G	R of network
R	Y of network
V-G	G of network
W	RR of 636QM Key
V-W	SG of 636QM Key
BK	6 of 636QM Key
G	ON1 of 636QM Key
O-BK	C of network

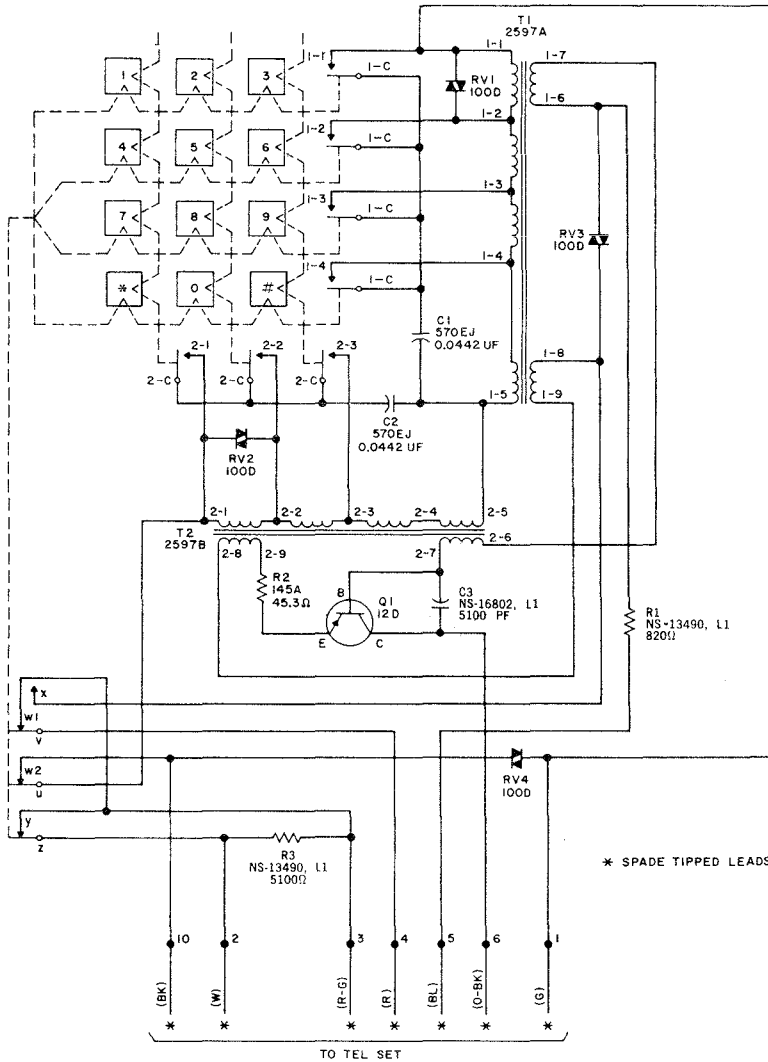


Fig. 4 - 35A3 Dial

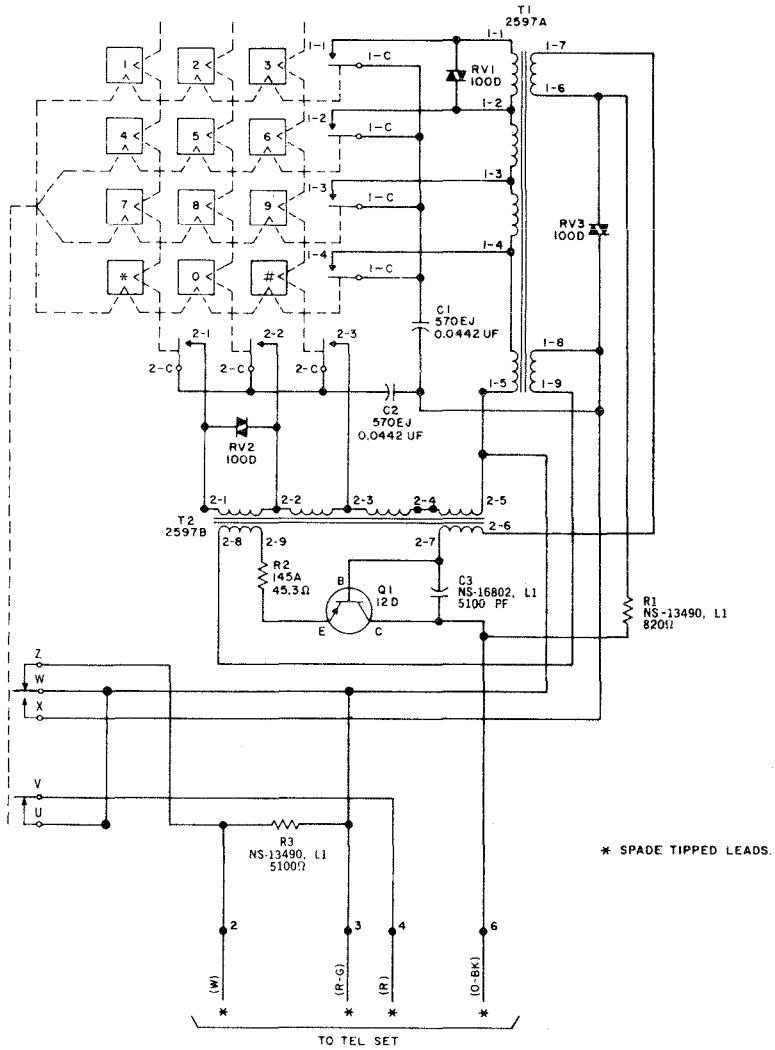


Fig. 4A - 35Q3A Dial

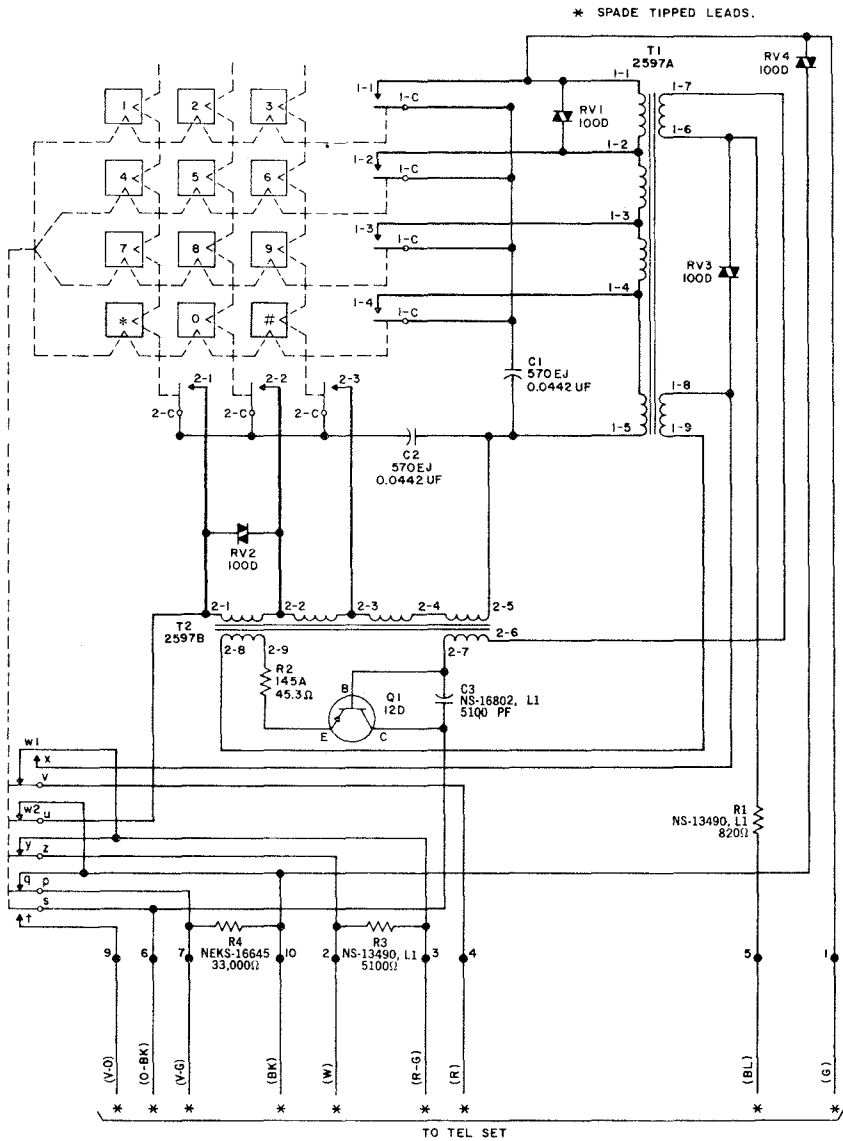


Fig. 5 - 35B3 Dial

\* SPADE TIPPED LEADS.

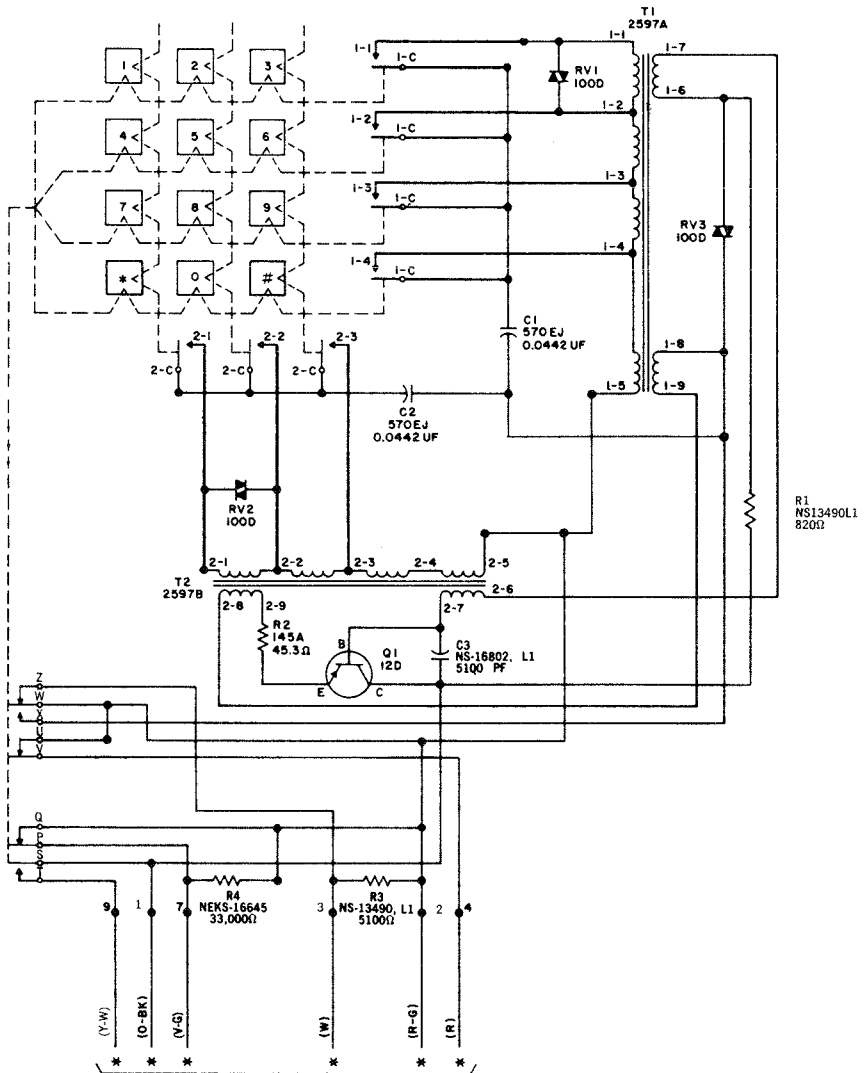


Fig. 5A - 35Q3B Dial

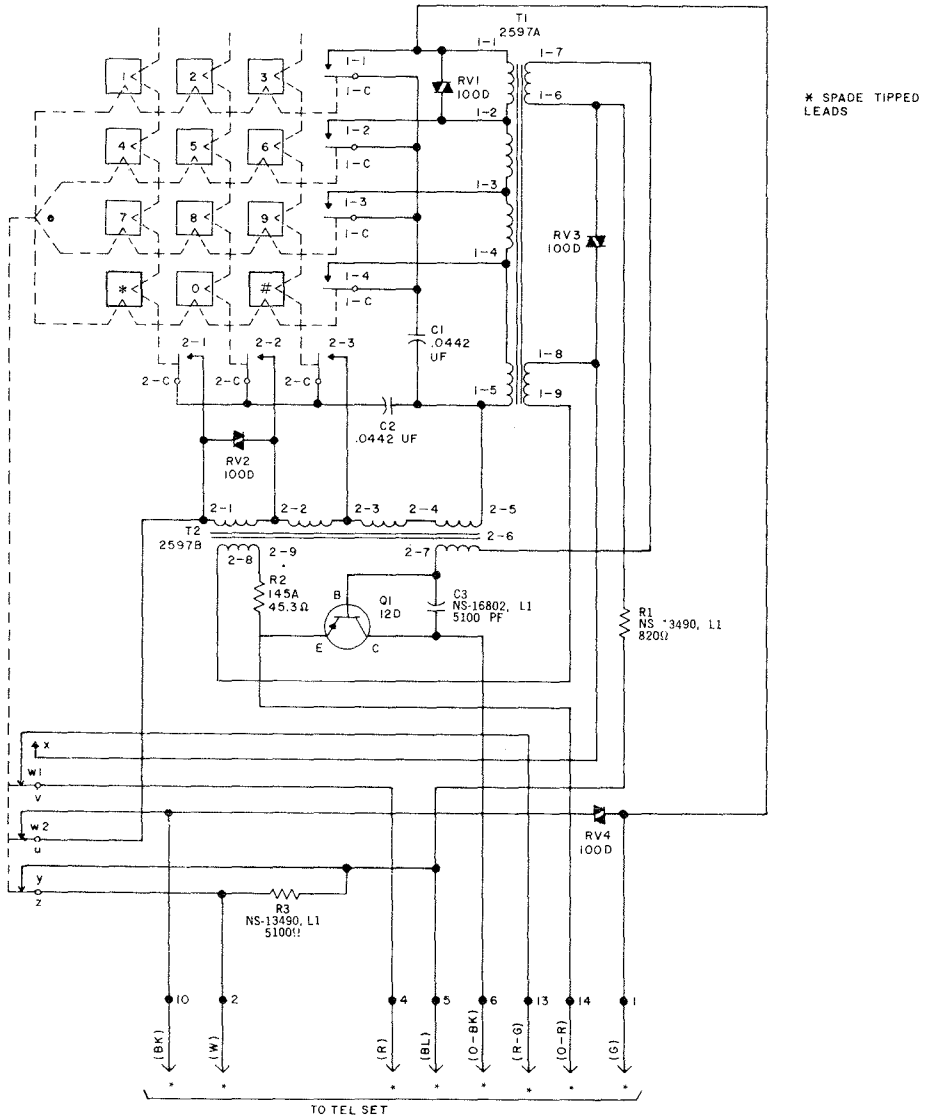


Fig. 6 - 35E3 Dial

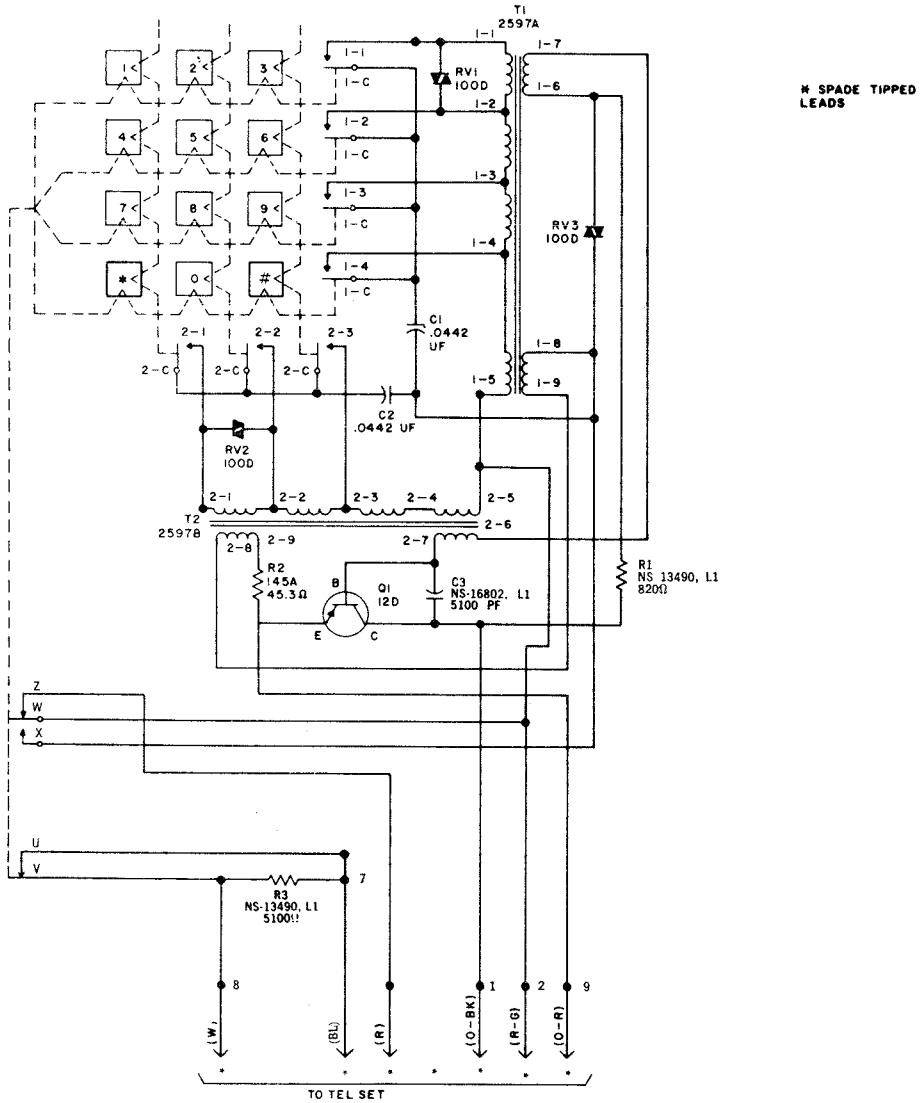


Fig. 6A - 35Q3E Dial

\* SPADE TIPPED LEADS

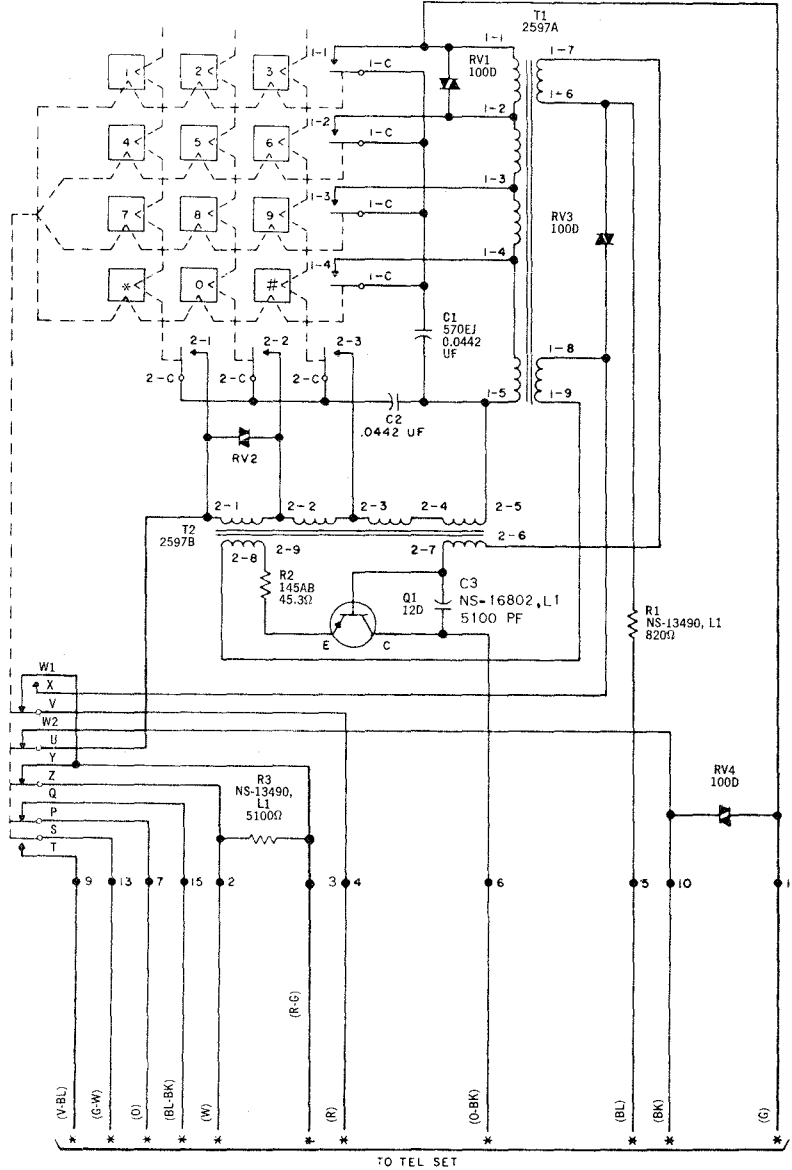


Fig. 7 - 35J3 Dial



SECTION 501-164-115CA

K SPADE TIPPED LEADS

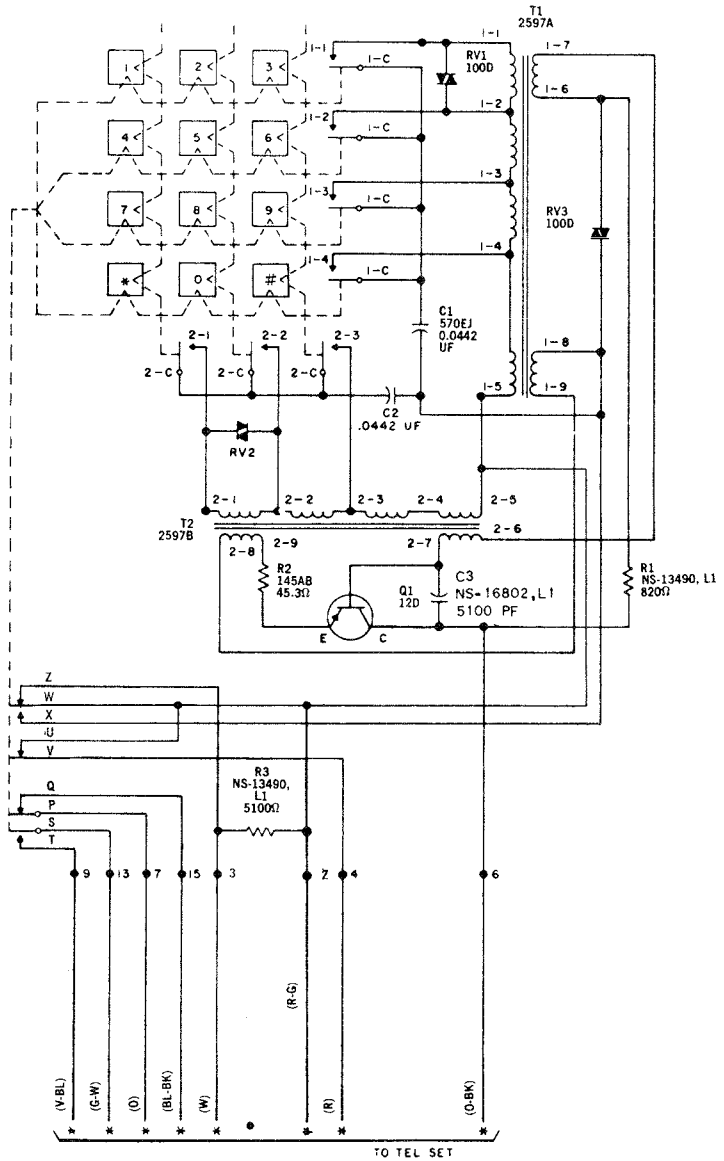


Fig. 7A - 35Q3D Dial

\* SPARE TIPPED LEADS

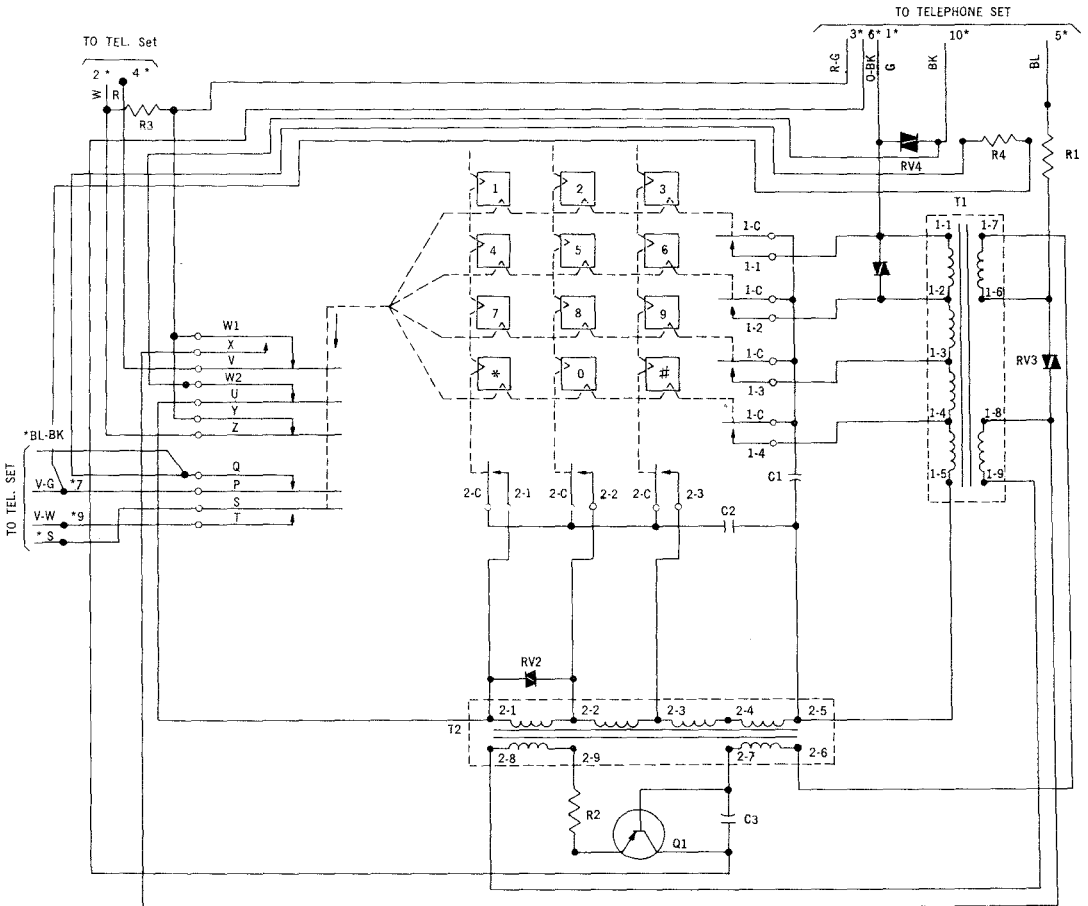


Fig. 8 - 35B3QA Dial

\* SPARE TIPPED LEADS

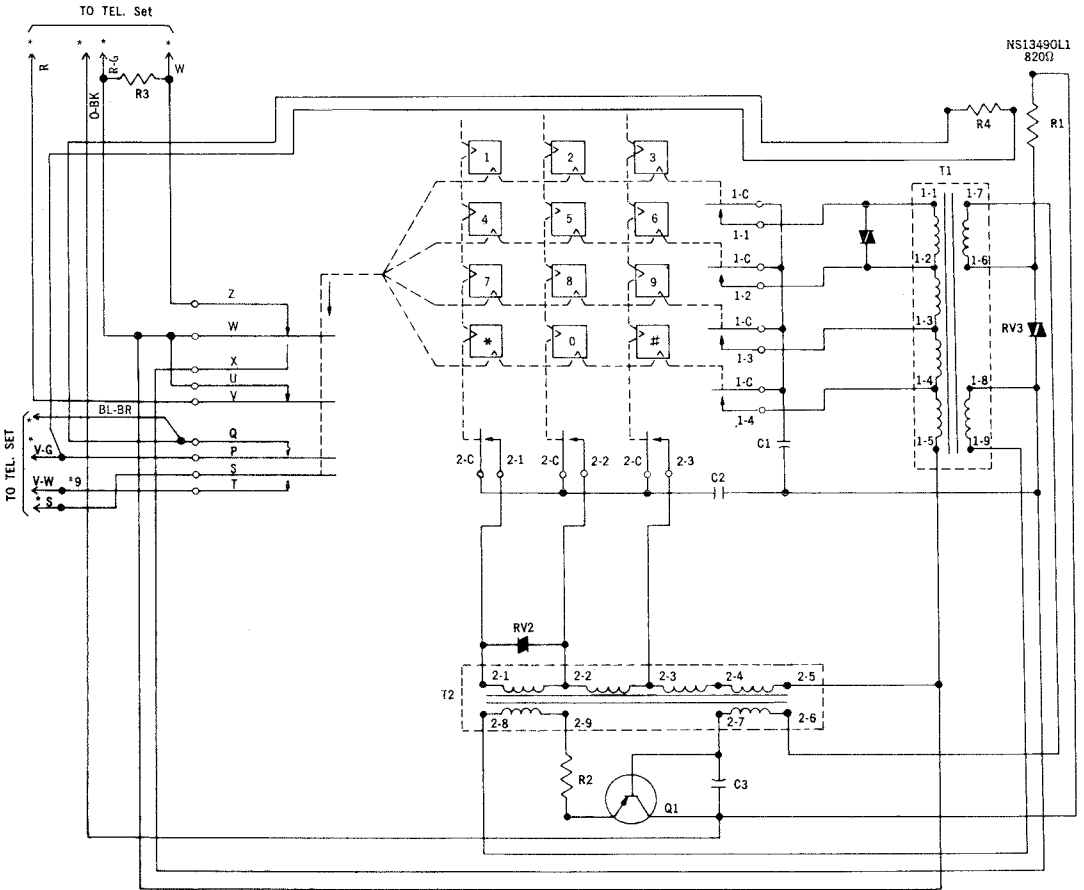


Fig. 8A - 35Q3C Dial

\*Spade Tipped Leads

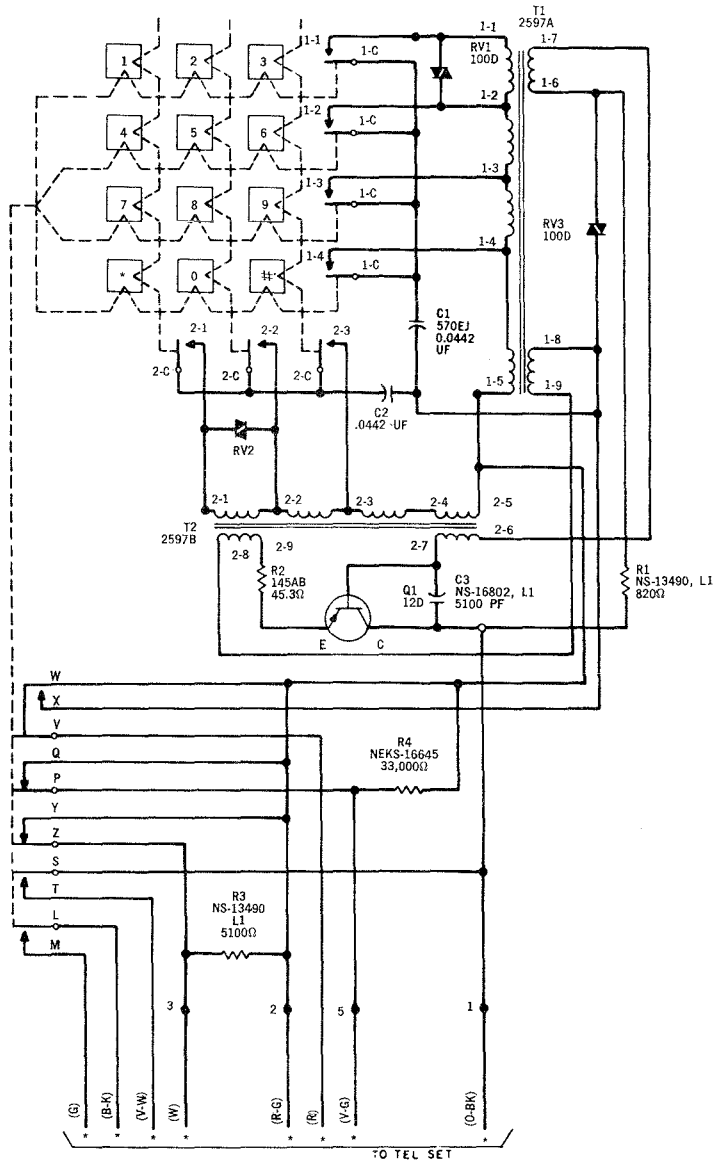


Fig. 9 - 35Q3J Dial



## QCY1A1 BELL CHIME

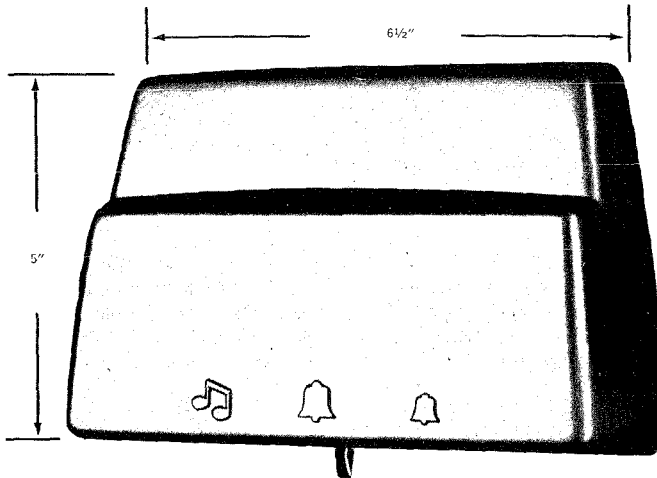


Fig. 1 — QCY1A1 Bell Chime with 125AN Cover in Place

**1. INTRODUCTION**

**1.01** This section covers the Identification, Installation, Maintenance and Connections of the QCY1A1 Bell Chime.

**1.02** This section is reissued to add information on how to secure the connecting block end of a general purpose set mounting cord when the cord is terminated in the QCY1A1 Bell Chime.

**1.03** Due to extensive changes, marginal arrows have been omitted.

**2. IDENTIFICATION**

**2.01** The QCY1A1 Bell Chime is a single coil (two windings) high impedance device equipped with:

- A 7-terminal connecting block
- A 498A network
- A lever to change the sound output from loud to soft or chime
- A cover with gold or ivory finish

**2.02** A QAA1A Adapter plate is available to facilitate mounting.

**3. GENERAL**

*Remove the QCY1A1 Bell Chime from the shipping carton with care prior to installation to avoid changing the adjustment of the interrupter switch assembly (Fig. 2). Handle the Bell Chime using the stop bar attached to the two gongs. Keep the Bell Chime in a plastic bag in the shipping carton prior to installation and when removed from service.*

**DO NOT LEAVE PLASTIC BAG WHERE IT IS ACCESSIBLE TO CHILDREN.**

**3.01** The Bell Chime is installed when covered by a service order. Typical installations would include:

- Centrally located bell chime
- Extension ringer

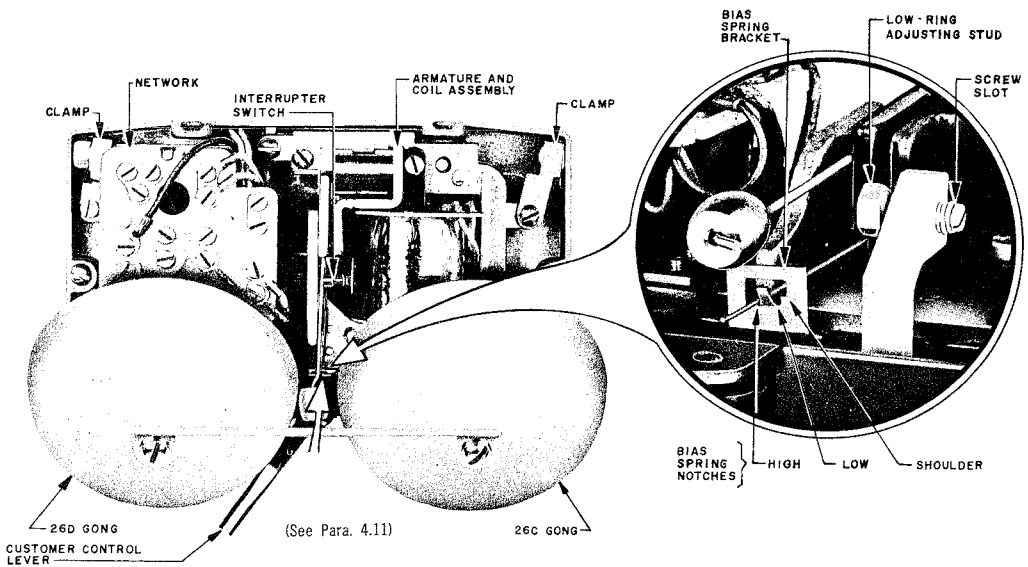
**SECTION 501-252-100CA**

- Ringer for the 701B (Princess Telephone Set)
  - Loud Ringer (substitute for 592A)
  - Common bell with key systems
- 3.02** The Bell Chime may be connected with the following classes of service:
- Individual lines
  - 2-Party lines
  - Regular PBX Stations
- 3.03** The Bell Chime is not intended to be used with any service where code ringing would not be distinguishable in chime position.
- 3.04** When tip party identification is required, it must be obtained through the ringer associated with each station. The connections are shown in the appropriate Bell System Practices section for the particular telephone set used.

**3.05** If tip party identification is required and the bell chime is not associated with a telephone set (located remotely), do not use this ringer for tip party identification. Connect it as a normal tip party ringer and consult the appropriate BSP Section for the telephone set connections for tip party identification with set ringer silenced.

**4. INSTALLATION**

- 4.01** Standard ringing bridge limitations apply to the use of this Bell Chime.
- 4.02** Suggest a location so that the customer can hear chime or low ring in the largest area of the residence. The Bell Chime will usually provide satisfactory coverage when centrally located in the house on the inside partition about 5 feet above the floor with the control lever accessible to the customer.



**Fig. 2 — QCY1A1 Bell Chime — Components**

**4.03** Use care to allow ample space above and to the right side of the Bell Chime when selecting an installation location. Allow enough space for tightening the cover screws on the top and adjusting the low-ring stud on the right side.

**4.04** The Bell Chime may be fastened directly to wall surface with two fasteners. Select length of fastener to provide secure mounting with particular wall material.

\* Use No. 8 RH Wood Screws when fastening to wood, wood studs, or lath.

**4.05** Where the Bell Chime is to be mounted using wall screw anchors, it may be convenient to use the QAA1A Bell Chime Adapter. The adapter can be mounted more readily than the Bell Chime and can be levelled more easily.

**4.06** Installation may be made on a commercial outlet and in locations with concealed wiring. Use the QAA1A Bell Chime Adapter. Note that certain holes in the Bell Chime and Adapter are elongated to assist in levelling the bell chime, (See Fig. 8). An additional wire entrance hole is provided to facilitate the installation of the Bell Chime mounted on a commercial outlet and in locations with concealed wiring. (See Figs. 3 and 4).

**4.07** The inside wire may enter the Bell Chime from the back, bottom, or either side.

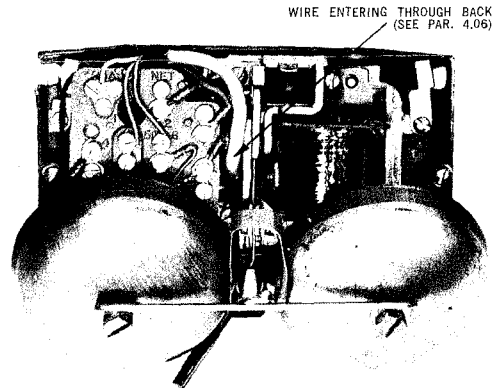
**4.08** When the inside wire enters the Bell Chime from the bottom or back, the mounting cord from the telephone set may be brought into either end of the Bell Chime.

**4.09** When the Bell Chime is used with a telephone set, the inside wire enters from one end and the set cord enters from the opposite end. Secure the set cord to the Bell Chime with the clamps provided.

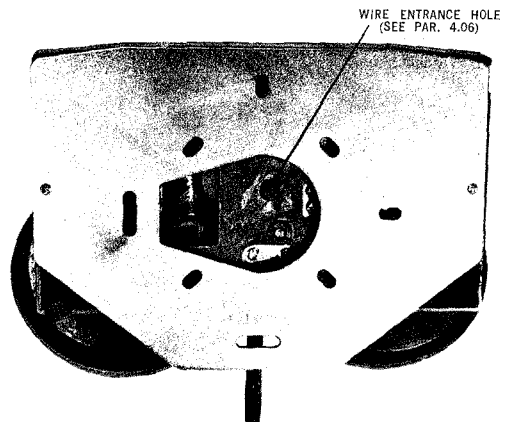
**4.10** The mounting cords of most telephone sets, other than the 701-type, have short leads to the connecting block end. The cord-stay-clamp in the Bell Chime will not keep a pull-strain off the spade tip connections on cords with short leads. To prevent spade tip connection failures in the Bell Chime when using cords with short leads perform one of the following:

(a) Install a QBB1A connecting block using inside wire between the block and the Bell Chime. Terminate the cord in the connecting block.

(b) Put several wraps of friction tape around the cord a few inches from the stay-band. This provides a grommet which should take up the stress against the cord-stay clamp if the cord is pulled.



**Fig. 3 — Front View of Bell Chime Showing Wire Termination (Entering From Back)**

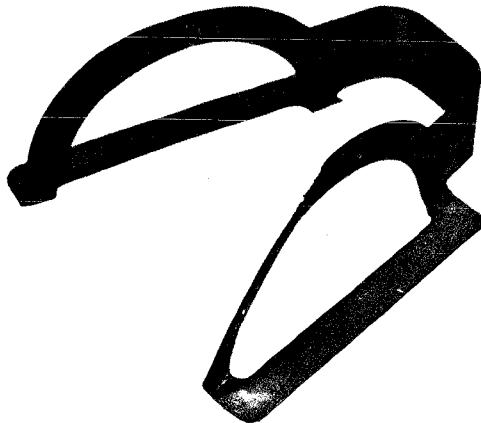


**Fig. 4 — Back View of Bell Chime and Adapter Plate, Showing New Wire Entrance For Outlet or Concealed Wiring Installation**

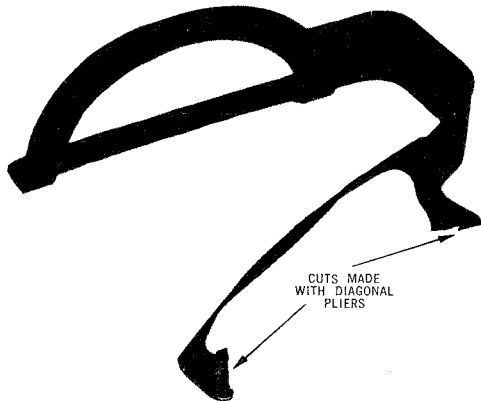


SECTION 501-252-100CA

4.11 Adjust the volume of the low ring by moving the adjusting stud (Fig. 2) right or left; use a small screwdriver in slotted end located beneath the right gong. The volume of the Bell Chime can be toned down in all three positions by the use of the 100B Gong Attachment modified as shown in Fig. 5.



UNMODIFIED



MODIFIED

Fig. 5 — 110 B Gong Attachment

4.12 The attachment should be fitted on the gong as shown in Fig. 6, making sure that no interference exists between the attachment and the control lever mechanism.

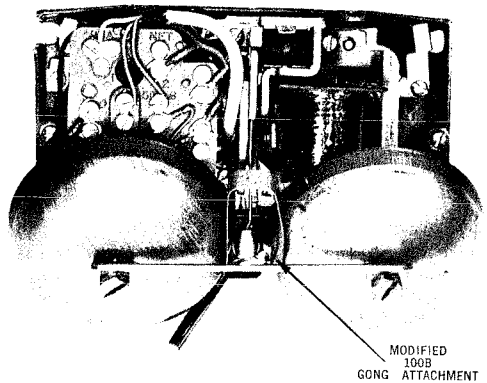


Fig. 6 — 100B Gong Attachment — Installation



*Be sure to acquaint customer with the location and use of the Bell Chime Control Lever.*

TABLE A  
BIAS SPRING POSITION

CLASS OF SERVICE		BIAS SPRING NOTCH	REMARKS
Bridged Ringing Service	Individual Flat, Message Rate and PBX Stations	High	The bias spring may be placed in low notch when double tap is experienced in CHIME position or when operation is not satisfactory with bias spring in high notch. If repositioning bias spring results in dial tap or poor operation, check ringer as outlined in Part 6.
Grounded Ringing Service	2-party Flat	High	

## 5. BIAS SPRING POSITION

**5.01** The Bell Chime is shipped with the bias spring in the high (left) notch. Do not move the bias spring to low notch unless trouble is experienced. The bias spring must never be placed on the shoulder located to the right of the low notch. Table A indicates proper position of bias spring for various classes of service (see Fig. 2).



*Correct bias spring tension has been set at the factory. Do not bend bias spring.*

**CAUTION:** Proper poling of the bell chime is very important to avoid double-tap in the chime position and bell taps while dialing.

**5.02** After completing work, obtain a ringing test in all three positions of subscriber switch. Obtain tests according to local instructions. Check for bell taps while dialing.

## 6. MAINTENANCE

**6.01** On a maintenance visit where Bell Chime fails to operate properly, proceed as follows:

- (1) Check airgap at armature for dirt or foreign material and clean if necessary.
- (2) Make sure all connections are tight and *correct*.

(3) See that all wires are dressed so that they do not interfere with operation of the Bell Chime.

(4) Clean interrupter switch assembly contacts when required, by carefully burnish with a 265C tool.



*Care must be taken to avoid changing adjustment of spring gap and spring tension of interrupter switch.*

**6.02** If the Bell Chime rings properly but armature sticks in operated position when the customer control lever is in CHIME position, replace the Bell Chime.

**6.03** If Bell Chime rings with customer control lever in CHIME position, proceed as follows:

- (1) Shift network mounting plate until interrupter switch stud just touches clapper rod.
- (2) If Step (1) results in double-tap, shift component plate back slightly toward original position.
- (3) If Steps (1) or (2) do not eliminate trouble, replace Bell Chime.

## 7. CONNECTIONS

**7.01** When tip party identification is required, it must be obtained through the ringer associated with each station. The connections are shown in the section for particular telephone set used.

**SECTION 501-252-100CA**

**7.02** If tip party identification is required and customer does not wish telephone set ringer associated with Bell Chime to ring:

- (a) F1A Ringer should not be used to give tip party identification.
- (b) F1A Ringer should be connected as normal tip party ringer.

(c) Telephone set should be connected for tip party identification with the ringer silenced as described in the section related to set.

**7.03** Table B gives connections for the Bell Chime. A circuit drawing is shown in Fig. 7.

**TABLE B**

**LINE AND RINGER CONNECTIONS FOR QCY1A1 BELL CHIME**

Wire or Lead		Colour	Individual or Bridged	Ring Party	Tip* Party
Inside Wire	Ring	R	6	6	1
	Tip	G	4	1	6
	GRD	Y	-	4	4
Ringer		R	7	7	7
		S-R	2	2	2
		S	2	2	2
		BK	4	4	4
Network Straps	G	BL	4	4†	4†
	A	R	7	7	7
	B	G	6	6	6

\* See Para. 3.04 and 3.05.

† Place BL strap on (1) whenever high ground induction is encountered.

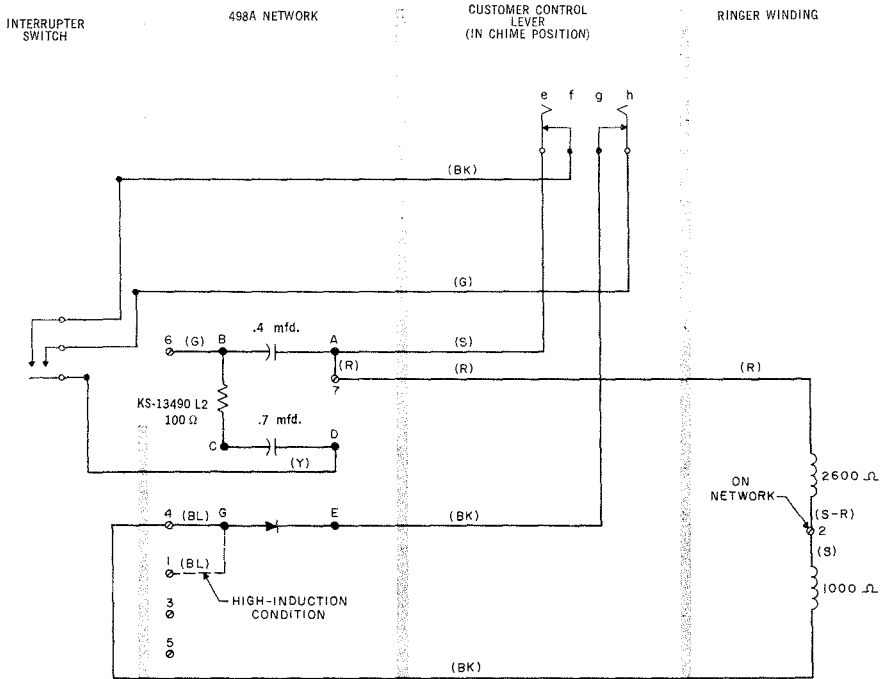


Fig. 7 - QCY1A1 Bell Chime -- Schematic

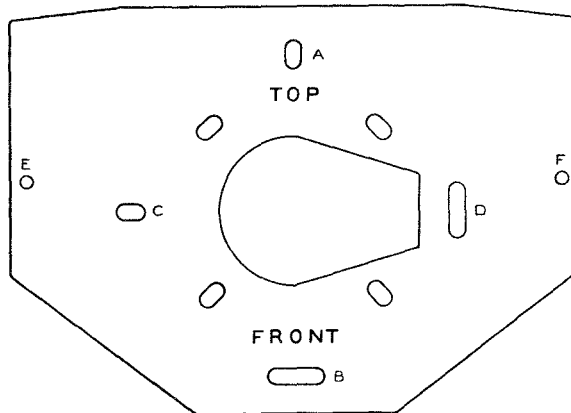


Fig. 8 - QAA1A Bell Chime Adapter

Note:

- A & B or C & D are used to mount the adapter on outlet boxes.
- E & F are used to mount the Bell chime.
- Other holes are for mounting adapter on hollow wall construction.



## RINGER ISOLATOR

(PO895087 KIT OF PARTS)

### IDENTIFICATION

#### 1. GENERAL

**1.01** The ringer isolator is an electronic switch which isolates a grounded ringer from the telephone line. It is intended for use on lines having induced voltage up to 140 volts RMS.

**1.02** The ringer isolator is designed to allow for easy installation in telephone set housings, Bell Chimes and L-type ringers, and subscriber sets. Due to limitations this device cannot be mounted in 701B Princess. Substitute a 702BQ1A, install the ringer isolator under the dial. Disconnect the red ringer lead from the K terminal and splice the yellow lead of a 548A capacitor, using the D161488 or QCM12A connector. Connect white lead of capacitor to black lead of ringer isolator.

**1.03** The isolator may be used on all grounded ringers except those used in 4-party full selective and 8-party semi-selective ringing service.



*One ringer isolator is required for each grounded ringer on the line. Lines equipped with isolators cannot be tested for continuity by conventional test desk procedures.*

#### 2. IDENTIFICATION

**2.01** The ringer isolator must be ordered as a PO895087 Kit, Ringer Isolator which consists of the components shown in Fig. 1.

**2.02** The ringer isolator (Fig. 1) consists of a two-transistor switching circuit mounted on a printed circuit board and encased in a vinyl insulating sleeve. The ringer isolator schematic is shown in Fig. 2. For connections refer to section 500-112-100.

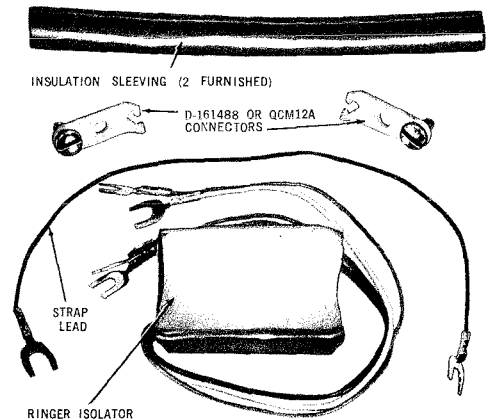


Fig. 1 — PO895087 Kit, Ringer Isolator—Components

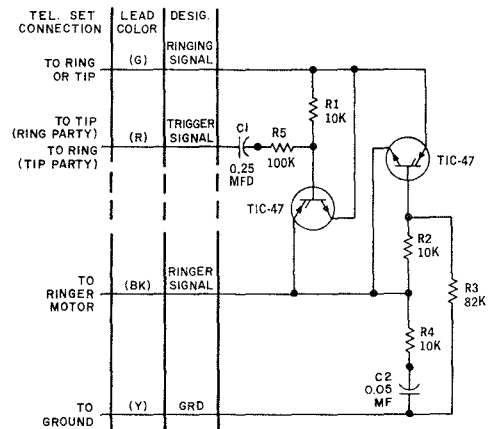
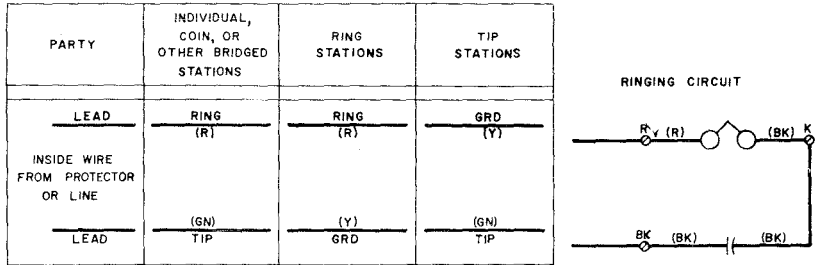


Fig. 2 — Ringer Isolator — Schematic

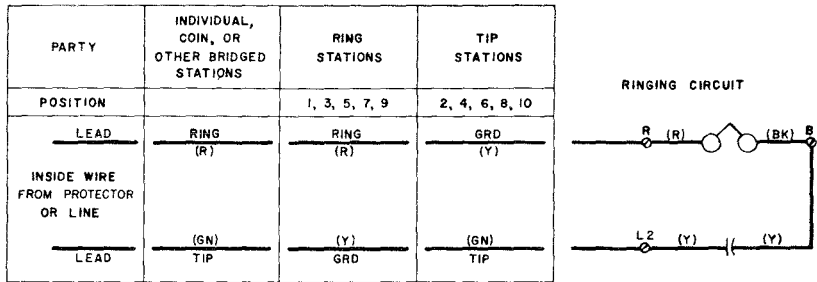


## SUBSCRIBER SETS

### EXTENSION RINGER — CONNECTIONS



**Fig. 1 — 392L and 592A Subscriber Set Connections**



**Fig. 2—584DX Subscriber Set Connections**



SECTION 502-210-400CA

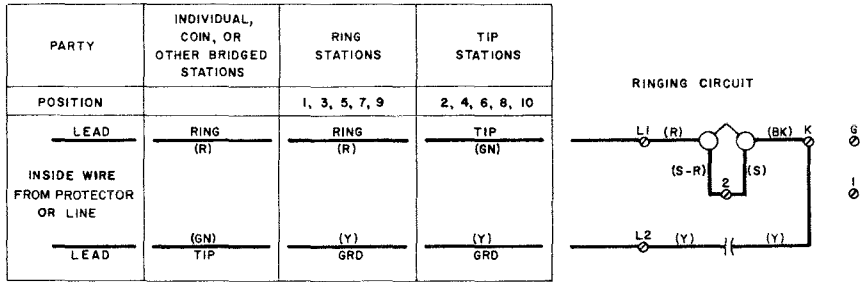


Fig. 3-687A Subscriber Set Connections

TELEPHONE SET

QSK100AX AND QSK2100AX  
 "CONTEMPRA" \*

1. GENERAL

1.01 This section covers description, identification, installation, connection and maintenance information for the QSK100AX and the QSK2100AX Contempra Telephone Sets.

1.02 These sets are significantly different in that the dials are located in the handset.

1.03 The QSK100AX has a rotary dial while the QSK2100AX contains a Touch-Tone Dial.

1.04 Use H3QA Handset for manual service. See Fig. 11 for handset connections.

1.05 This section is reissued to make minor revisions and add connection information for 3A Speakerphone System.

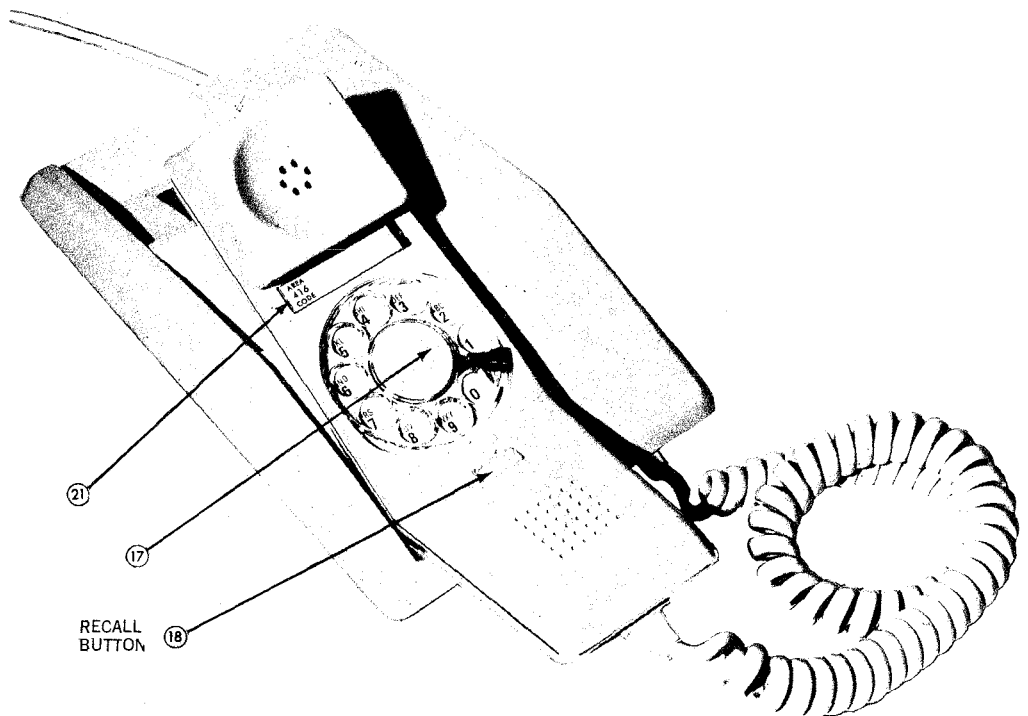


Fig. 1 — Desk Mounted "Off-Hook" Position QSK100AX

\*Trademark of Northern Electric Company Limited

© Bell Canada, 1972  
 Printed in Canada

2. DESCRIPTION

2.01 The QSK100AX, a two-piece telephone set (Fig. 1), consisting of base and handset is a combined desk-wall-type telephone. When used as a desk-type telephone, it rests on the feet provided in the base of the set. When used as a wall-type set, it is mounted using the mounting holes in the baseplate.

2.02 The rotary dial, provided as a component of the handset, is smaller in diameter than the dials in general use. A moveable fingerstop is a feature of the dial that allows the normal space between the "1" and "0" fingerholes of the fingerwheel to be reduced resulting in a more compact dial.

2.03 A 3 Conductor Mounting Cord is provided with the set. Other mounting cords, if

required, may be ordered separately. The code of the cord varies with the service to be provided. (See Para. 3.03).

2.04 The QSK2100AX Touch-Tone version is shown in Fig. 1A.

2.05 When these sets are used as a desk set, the handset, when in place, rests in the recess provided in the base of the set. When used as a wall set and the handset is in place, the lower edge of that portion of the handset that houses the receiver unit engages a projection provided as part of the handset recess.

2.06 The transmission circuit is the same as for the 500-type set.



Fig. 1A — Desk Mounted QSK2100AX "Off-Hook" Position

### 3. IDENTIFICATION

3.01 The telephone set is furnished wired for individual service. Wiring changes are made to allow its use for the following services:



- Tip party flat rate service.
- Ring party flat rate service.
- Use with 1A1 and 1A2 Key Systems.
- Not to be used for Tip Party A.N.I.

3.02 The telephone set is available in the following colours:

- WARM WHITE — 20

- DEEP TURQUOISE — 21
- MAUVE — 22
- BRIGHT RED — 23
- PALE YELLOW — 24
- DEEP BLUE — 25
- IVORY — 50
- GREEN — 51
- BEIGE — 60

3.03 Identification of Parts:

(See Table A)

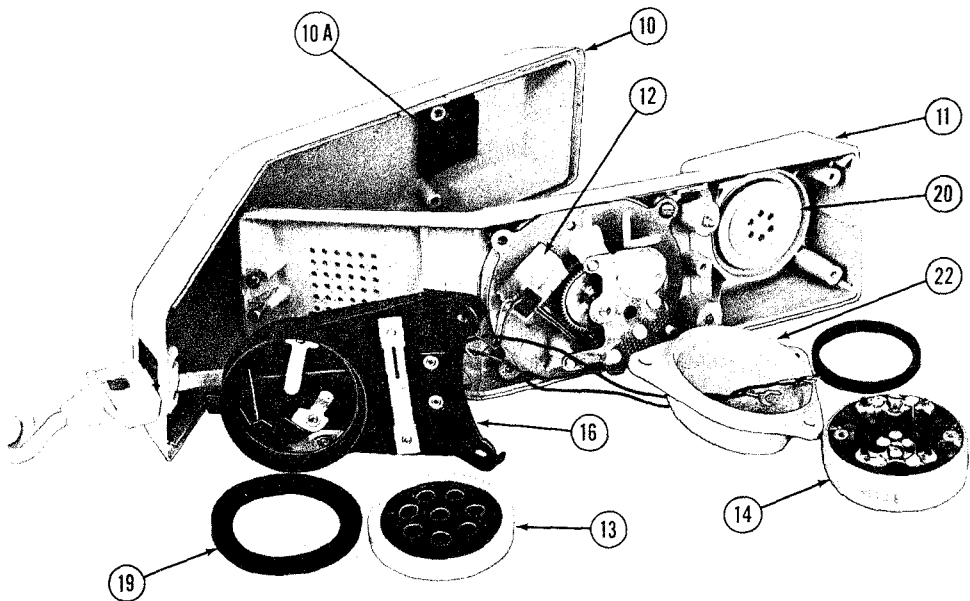


Fig. 2 — Parts, Handset Assembly QSK100AX

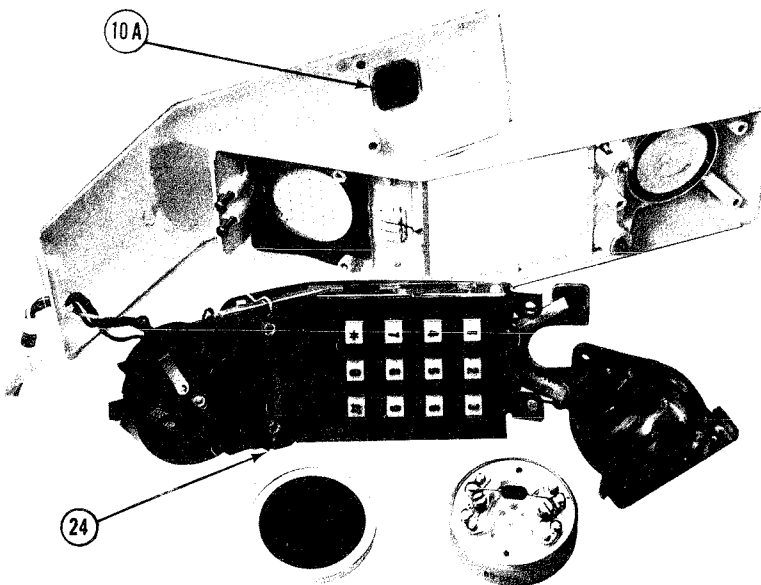


Fig. 2A — Parts Handset Assembly QSK2100AX

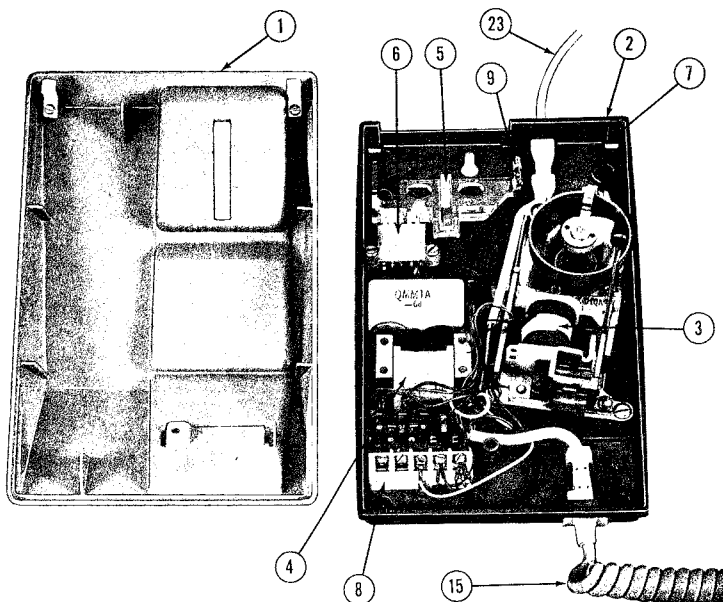


Fig. 3 — Parts, Base Assembly

TABLE A

DETAIL	CODE	DESCRIPTION	REMARKS
1		HOUSING (BASE)	FIG. 3
2		BASE PLATE	"
3	D1QA	RINGER	"
4		NETWORK	"
5	PO96D337	LEVER SWITCHHOOK	"
6	PO894971	ASSEMBLY CONTACT SWITCHHOOK	"
7	PO96D326	FOOT	"
8		ASSEM TERMINAL STRIP	"
9	PO96D322	SPRING	"
10		HANDSET COVER	FIG. 2
10A		PAD	FIG. 2A
11		HANDSET INSTRUMENT SECTION	FIG. 2
12	10QAX	DIAL	"
13	T1	UNIT TRANSMITTER	"
14	U1	UNIT RECEIVER	"
15	H5QE-*	CORD HANDSET	FIG. 3
16	PO96D309	ASSEM TRANSMITTER CUP	FIG. 2
17	PO96E700 to 799*	DISC CENTRE DIAL	FIG. 1
18		RECALL BUTTON	"
19		GASKET TRANSMITTER	FIG. 2
20		GASKET RECEIVER	"
21	PO96D313	CARD HOLDER WINDOW	FIG. 1
22		RECEIVER BRACKET	FIG. 2
23	D3Q5A-*	5' 6" CORD	} NOTE 1 NOTE 2
	D4QC-*	CORD	
	D6QB	CORD	
24	PO896593	ASSEMBLY DIAL (Includes Transmitter Cup)	FIG. 2A

NOTE 1: D4QC cords are available in 5 ft. 6 in. and 13 ft. lengths and will be ordered as required for 1A1 Key Systems or when individual or 2-Party installation includes 13 ft. cord.

NOTE 2: D6QB cords are available in 5 ft. 6 in. and 13 ft. lengths and will be ordered as required for 3A Speakerphone connections. The black lead will be spare and should be insulated.

\* COLOUR SIGNIFICANT: Colour identification code replaces last two digits of P-numbered parts and is added to cord codes.

SECTION 502-321-910CA

**3.04** The telephone sets have a printed circuit-type network, QNB18A, that is equipped with quick connect type terminals. Connections are made by pushing the spade tips into spring-type clips on either side of the terminal. To avoid damage to the leads, use longnose pliers and a slight sideways rocking motion when connecting or disconnecting. *Use caution to assure shank of clip is not bent.*

**3.05** Located in the handset is the recall button which can be used to disconnect for re-dialing, thus eliminating the need to operate the switchhook on each call.

**3.06** To adjust the ringer volume, a wheel that protrudes through the baseplate at the side of the set, has been provided. Moving a screw will allow this wheel to completely silence the ringer. However, ringer cut-off must not be provided unless authorized by a service order. (see Para. 4.04).

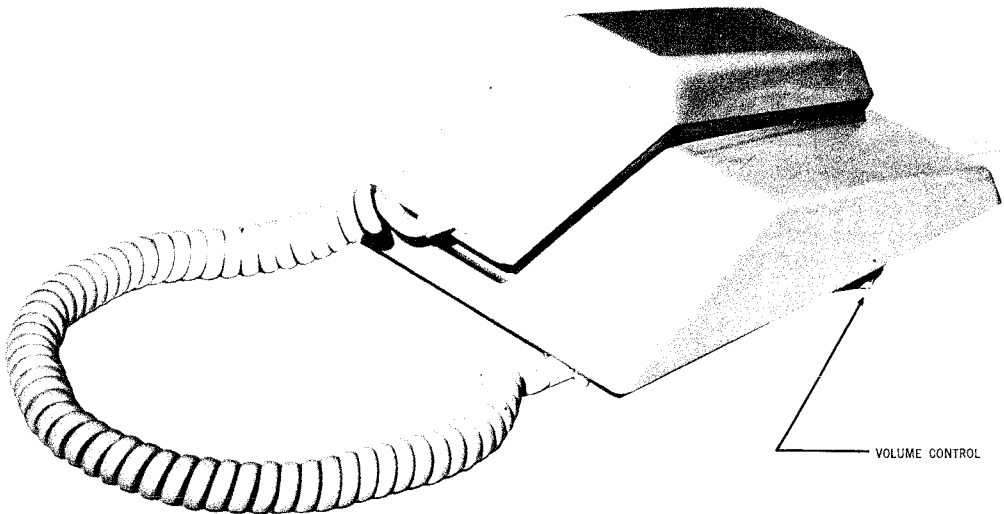


Fig. 4 — Location of Ringer Volume Control Wheel

4. INSTALLATION

4.01 Selection of location and general installation shall be as covered in Sections

502-120-200 and 502-120-201, respectively. However, as the set is a combined desk-wall telephone, additional information is provided.

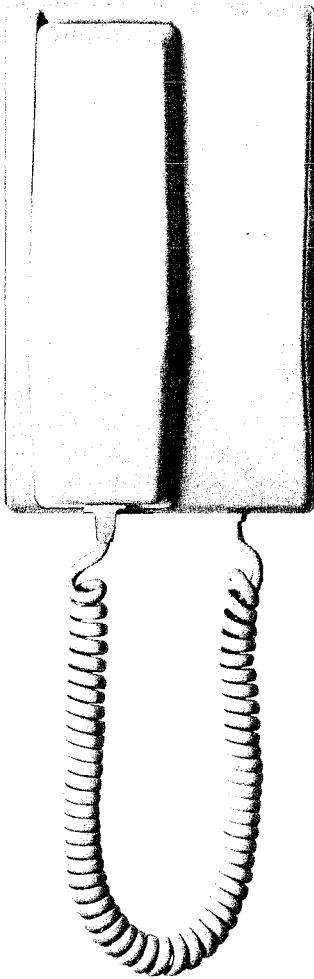


Fig. 5A — Wall Mounted "On Hook"

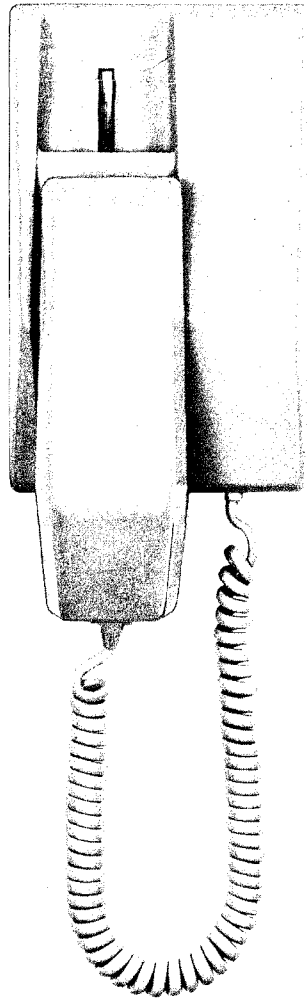


Fig. 5B — Wall Mounted "Off Hook"

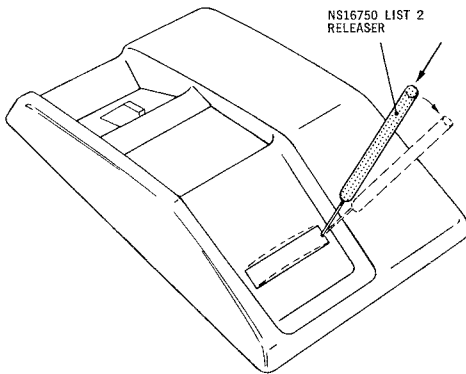


## 4.02 DISASSEMBLY

**To Remove the Moulded Housing From the Base:**

- (a) Remove card retainer (or window), located near the front of the housing.

To remove card retainer, insert the tip of the NS16750 List 2 releaser into the small slotted hole at the edge of the transparent window. Ensure that the tip does not enter the hole by more than one-eighth of an inch as an underlying screw may hinder the lateral movement of the tool. Apply a slight pressure to the handle of the tool, (See Fig. 6). The housing projection provides a fulcrum. This will bow the window upward so that its edges may be grasped with the fingertips of the other hand to spring it out.



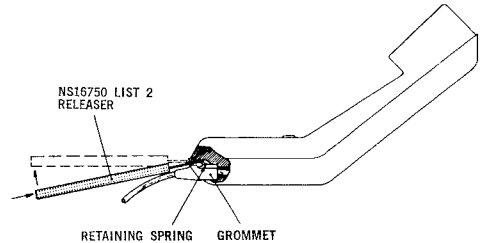
**Fig. 6 – Removal of Card Retainer**

- (b) Remove the number card, if present.
- (c) Loosen the exposed captive screw and run it out sufficiently so that the front of the housing may be lifted free of the base.
- (d) Continued lifting of the cover enables the housing latches to disengage and free the cover.

**To Open the Handset:**

- (a) Remove the card retainer and the number card located above the dial.
- (b) Remove the handset grommet by holding the handset with the back or smooth section in the palm of the hand. Insert about 1/16"

of the tip of the NS16750 List 2 releaser into the small slot adjacent to the grommet (See Fig. 7). Press the handle of the tool towards the grommet and push the shank into the slot as far as it will go. Push the handle of the release tool away from the grommet to release the returning spring and gently ease the grommet out of the handset shell.

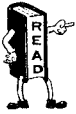


**Fig. 7 – Removal of Handset Grommet**

- (c) Once the grommet has been withdrawn, two screws are exposed. Loosen these two screws by about 3/16" only, as it is not desirable or necessary to remove them.
- (d) Free (do not remove) the two captive screws in the card retainer well. Loosen sufficiently to separate the handset sections at the receiver end, then slide the smooth or back half of the handset housing towards the cord grommet to release this section from the slotted screw holes at the grommet.

**Installation of Line Mounting Cord (D3Q5A)**

- (a) Enter the spade tipped leads at the grommeted end of the line cord through the square hole in the edge of the base.
- (b) Push the grommet through the opening so that the narrow section aligns with the square projections directly in front of the grommet entry.
- (c) Push the grommet firmly down to engage between projections.
- (d) Press the jacketed portion of the cord into the channel beside the D1QA ringer and between the projections located about midpoint on the base. Dress the leads under the existing wiring; loop them around the right side of the housing screw stud and connect to the terminal block, per Table B or D.

**4.03 WALL MOUNTED**

**Ensure that the Right Side of Set is Located Far Enough from Moulding or Door Frames to Permit Operation of Ringer Volume Control.**

Remove line cord. The centre key opening in the base is normally used for the entry of the station wiring.

**Note:** Return the line cord to the storeroom in the plastic bag provided to protect the handset.

The slots at the hookswitch end of the set and the one just below the ringer, are used for normal wall mounting.

For mounting on an outlet box, the key at the centre of the set and the one just below the ringer are used. Additional space may be opened for the entrance of wire from the outlet box, when necessary, by placing the set on a flat surface, placing a screwdriver in the indent adjacent to the centre key and giving the screwdriver a sharp knock downward. This action will shear out an additional opening leading into the centre key.

If a mounting screw fails to hold, knock-outs can be made, as above, near the handset cord or under the switch plunger, as necessary, for the addition of another screw without having to move the complete installation. These knock-outs should not be opened unnecessarily.

If it is necessary to bring the station wire up the wall from the baseboard, an opening can be uncovered for the wire entry by removing the handset cord grommet from the base, rotating it 180° and replacing it.

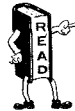
**4.04** To provide the ringer cut-off feature (authorized by service order), change the position of the lever associated with the ringer volume control wheel. With housing of the base off, remove the screw that holds the lever in contact with the wheel, shift the lever to the opposite end of the slot, place the screw in the hole that was under the lever and tighten.

**4.05 REASSEMBLY****Base**

- (a) Dress line cord leads and other wiring away from the housing retaining screw post on the base of the telephone set.
- (b) Locate housing at an angle to the base as shown in Fig. 8.
- (c) Press rear of housing down and towards the back of the base to engage the housing latches with the notches in the base.
- (d) Push front of housing down, ensuring that latches remain in notches, so that the retaining screw enters the tapped post in the base.
- (e) Carefully tighten the screw snugly, without undue force.
- (f) Insert a station card number and the retainer window in the well in the base.

**Handset**

- (a) Align the jacketed portion of the handset cord, which projects beyond the grommet and into the handset, so that it will fit the channel in the transmitter cup assembly.



**(b) Dress Receiver Leads Through Clip To Prevent Interference With Dial QSK100AX Set Only.**

- (c) Slide the two handset sections together so that the two slots at the grommet end slide over the two screws in the apparatus section.
- (d) Carefully align sections so that the two screws in the number plate slot will engage the tapped post holes in the other section.
- (e) Tighten screws; two in the grommet cut-out and two in the number plate well. Tighten the screws snugly without undue force.

## SECTION 502-321-910CA

(f) Slide the grommet into the square hole in the end of the handset housing with the retaining clip facing the instrument section of the handset. Fully seat the grommet so that the clip will engage. The grommet shoulder should be flush with the surface of the housing.

(g) Insert a station number card and retainer window into the well on the handset.

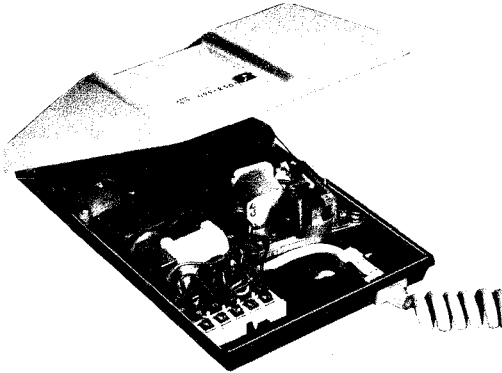


Fig. 8

**4.06** If unable to dial after completing installation check line polarity as Touch-Tone Dial will only function when polarity is correct.

### 4.07 DIAL RESTRICTION

#### QSK100AX Telephone Set

- (a) Connect IN4384 diode between GN and OR terminals of the handset.
- (b) Assume negative battery is on ring and ground is on tip of dialing circuit. With the arrow on diode pointing toward OR terminal, all lines will be restricted. Reverse tip and ring of line, or lines, on which dialing is required. This will remove shunt from across pulsing contacts on these lines.
- (c) With arrow on diode pointed toward GN terminal, no line will be restricted. Reverse tip and ring of line, or lines, on which dialing is to be restricted. This will shunt pulsing contacts on these lines.

## 5. MAINTENANCE

**5.01** Normal maintenance will involve replacement of the following parts. (See Para. 3.03 for identification of parts.)

- DIAL (QSK100AX Only)
- CORDS
- TRANSMITTER
- RECEIVER
- FEET
- SWITCHHOOK (See Caution Note)
- TRANSMITTER CUP (QSK100AX only)
- ASSEMBLY DIAL (includes Transmitter cup) (QSK2100AX Only)

*Caution: Hookswitches and Recall switches in Contempra telephones must not be burnished, as this destroys the gold plating. Use bond paper or contact spray. If these methods fail, replace telephone set.*



*Dial Maintenance consists only of determining if the dial is defective. Do not attempt adjustments of the dial in the field.*

**5.02** To replace Rotary Dial:

- See Para. 4.02 for instructions on opening of handset.
- Remove dial leads from terminals located on transmitter cup.
- Remove 4 mounting screws.
- Replace dial.
- See Para. 4.05 for instructions on reassembly of handset.

**5.03** To replace dial assembly (Touch-Tone).

- See Para. 4.02 for opening of handset.
- Disconnect handset cord and receiver leads.
- Remove 1 screw from each side of transmitter cup.
- The dial and transmitter cup assembly may then be replaced.
- Replace receiver leads and handset cord wiring.

**5.04** To replace transmitter:

- Open handset (see Para. 4.02).
- Remove the 2 screws holding the transmitter cup.
- Lift transmitter cup and replace transmitter.
- Close handset. (Para. 4.05).

**5.05** To replace receiver:

- Open handset (see Para. 4.02).
- Remove 3 screws holding receiver bracket.
- Slide bracket along the leads.
- Disconnect and replace receiver unit.
- See Para. 4.05 for reassembly of handset.

**5.06** *Finger Wheel*

Should finger wheel require replacement, replace the complete dial as replacement in the field may result in permanent damage to the dial. The finger-wheel need not be removed for number tag insertion.

**5.07** *Disc Centre Dial*

Insert the NS16750 L2 releaser in the small hole adjacent to the number 5 hole and pry disc off.

**5.08** *Ringer*

- Open base (see Para. 4.02).
- Loosen screw in volume control and remove ringer mounting screws.
- Replace ringer.

**5.09** *Cord Mounting*

- Mounting cord replacement covered in Para. 4.02.

**5.10** *Cord (Touch-Tone Handset)*

- The outer sheath of the handset cord must be cut back to within 1 inch of the handset grommet. (see Figs. 9 and 10).
- See Tables C and D for base and handset connections.

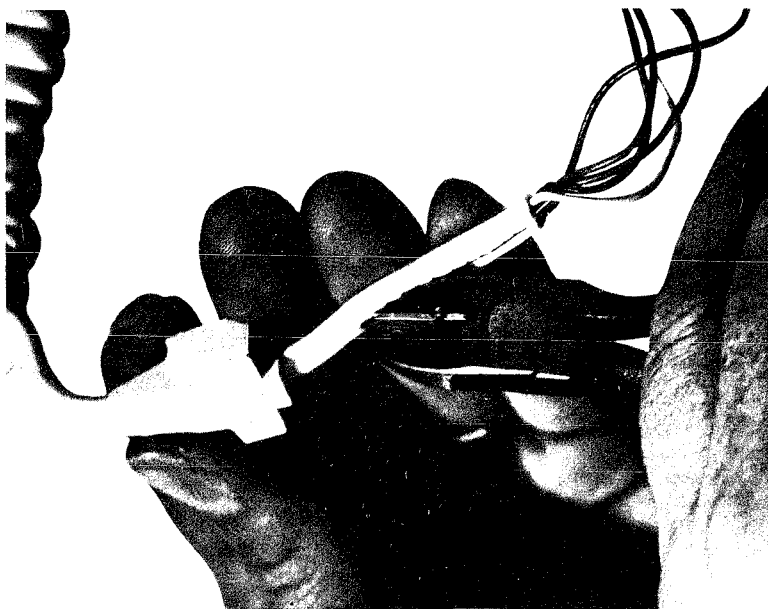


Fig. 9 — Slitting Sheath

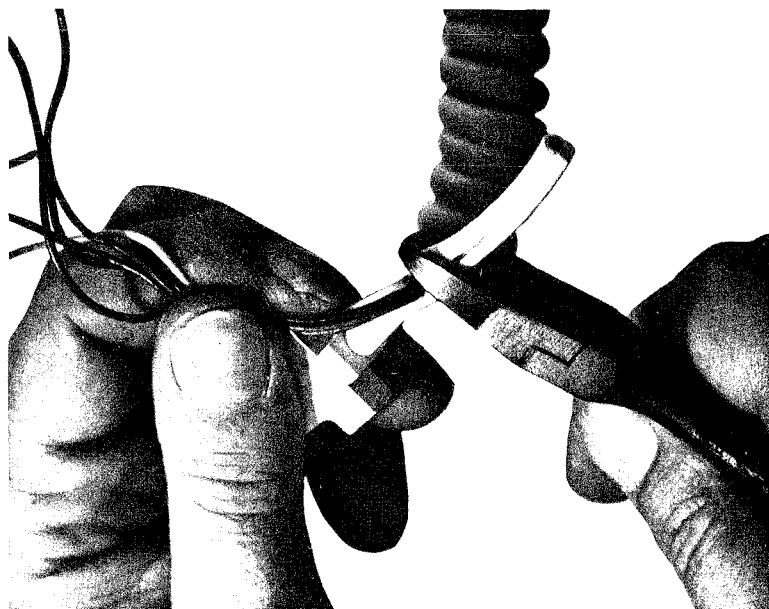


Fig. 10 — Cutting Sheath

TABLE B – ROTARY

QSK100AX Set Wiring	Lead Designation	Colour	Individual or Bridged	Ring Party	TIP Party	1A1 Key System	3A Speaker Phone System
Ringer Leads		R BK S S-R	L2 L1 K A	L2 G K A	L2 G K A	C L1 K A	C L1 K A
Switchhook LEADS		S S-Y S-BR	L3 L2 C	L3 L2 C	L3 L2 C	L3 G L2	L2 Y G
LINE WIRING Private & Party Line Common Battery	TIP RING GRD	G R Y	L1 L2 G	L1 L2 G	L2 L1 G		
1A1 Key System	TIP RING A A1	G R Y BK				L1 C* G L2	
3A Speakerphone SYSTEM See Notes 1 and 2 below Table E.	TIP RING A1 AG LK	G R Y BL W					L1 C** Y G L2

\* For wall mounted sets, connect the Ring (red) incoming line to Y on terminal strip and strap Y to C of network using an M1W Cord.

\*\* For wall mounted sets, connect the Ring (red) incoming line to X on terminal strip and strap X to C of network using a M1W Cord.

TABLE C

QSK100AX		
H5QE Cord Colour	Base	Handset
G	F	GN
Y	RR	Y
BL	GN	BL
BK	R	BK
R	B	R

TABLE D — TOUCH-TONE

QSK100AX Set Wiring	Lead Designation	Colour	Individual or Bridged	Party Ring	Tip Party	1A1 Key System	3A Speaker Phone System
Ringer Leads		R BK S S-R	L2 L1 K A	L2 G K A	G L1 K A	X L1 K A	X L1 K A
Switchhook LEADS		S S-Y S-BR	L3 L2 X	L3 L2 X	L3 L2 X	L3 G L2	L2 Y G
LINE WIRING Private & Party Line Common Battery	TIP RING GRD	G R Y	L1 L2 G	L1 L2 G	L1 L2 G		
1A1 Key System	TIP RING A A1	G R Y BK				L1 X* G L2	
3A Speakerphone SYSTEM See Notes 1 and 2 below.	TIP RING A1 AG LK	G R Y BL W					L1 X Y G L2

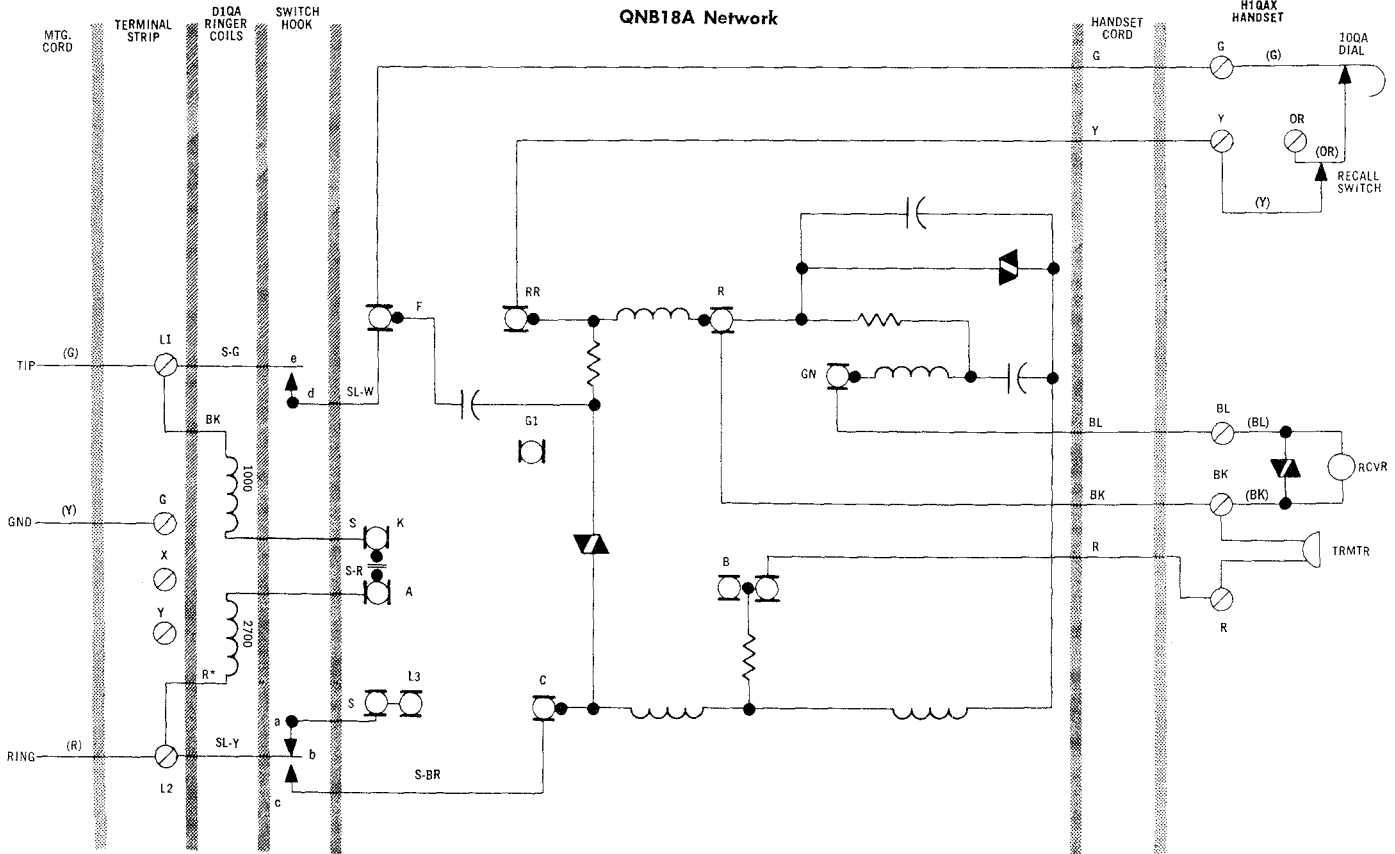
\* For wall mounted set, connect the Ring (red) incoming line to Y on terminal strip and strap Y to X using an M1W Cord.

TABLE E

QSK2100AX SET		
H5QE Cord Colour	Base	Handset
G	X	GN
Y	C	Y
BL	GN	BL
BK	R	BK
R	B	R

**Notes:**

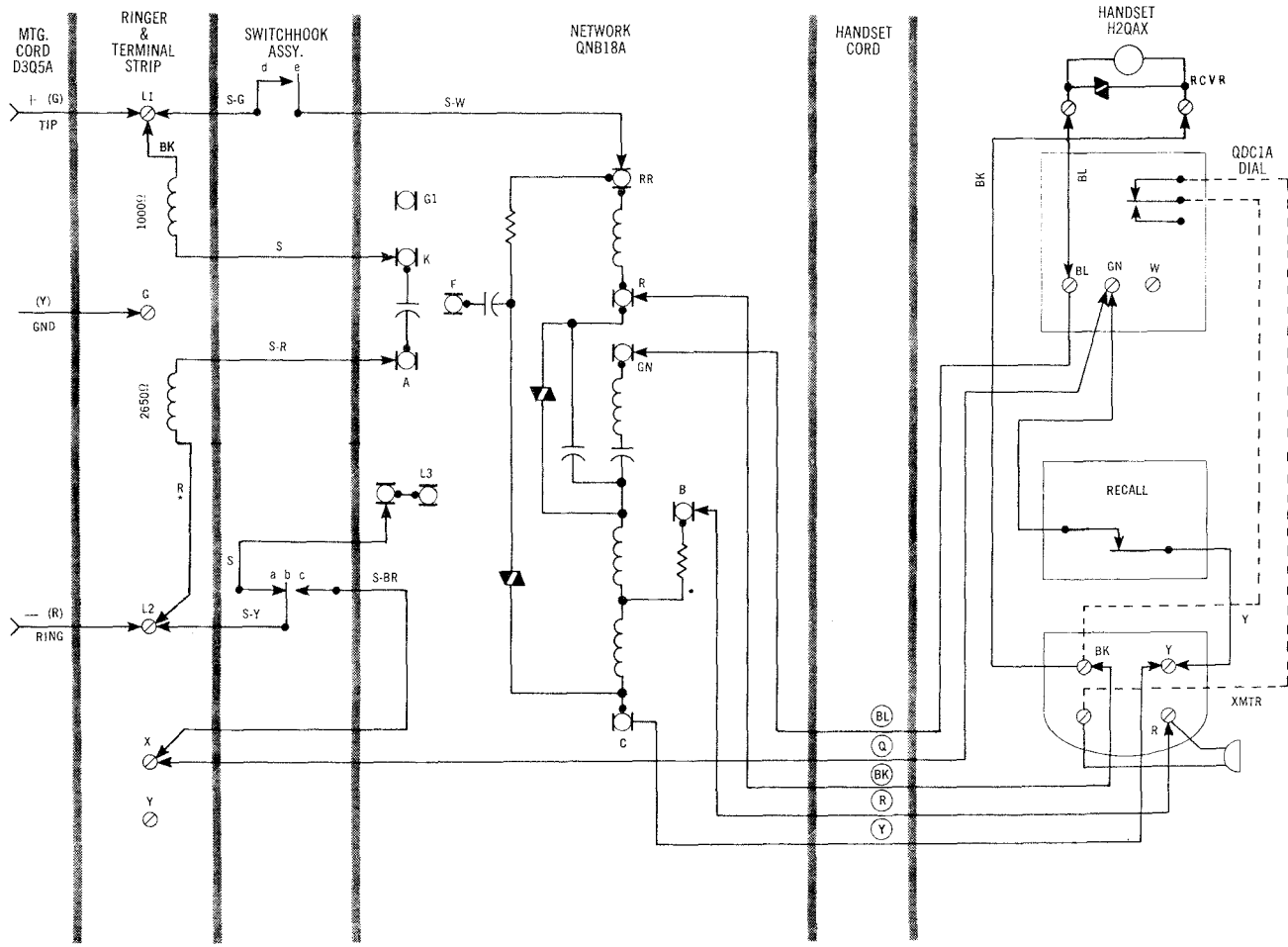
1. For 3A Speakerphone connections, the D6QB line cord is necessary. The black lead should be insulated.
2. When using QSK100 telephone or QSK2100 telephone set with 3 type speakerphone, make outgoing calls with handset off-hook and transfer to the speakerphone when dialing is complete. To transfer depress the "ON" button of the 666 type transmitter and hold it down until the handset is returned to the base.



\*EARLY MODELS MAY HAVE R LEAD CONNECTED TO L3.

**Fig. 11 — Schematic for Individual Line QSK100AX Rotary Dial  
(See Table B for other uses)**





\*EARLY MODELS MAY HAVE R LEAD CONNECTED TO L3.

Fig. 12 — QSK 2100 AX Touch-Tone Bridged Individual

## CONTEMPRA — MESSAGE WAITING

### QSK 100 BX

#### 1. GENERAL

1.01 The section covers identification, installation connections and maintenance for the QSK 100 BX Contempra Message Waiting Telephone.

1.02 This section is reissued to:

- Add Fig. 1.
- Describe the message waiting feature.
- Include maintenance procedures.
- Update functional schematic.

#### 2. IDENTIFICATION

2.01 The QSK 100 BX Telephone Set is equipped with a message waiting lamp (Fig. 1). The red message waiting lamp cap is factory molded into the housing of the telephone set. The lamp protrudes through the housing into the lamp cap.

2.02 The QSK 100 BX Telephone Set is to be used with a PBX which provides the message waiting feature. It is arranged to receive and hold a visual signal under control of an attendant at a PBX. General application for this feature is in a hotel or motel, however, it can be provided for any station under the control of an attendant.

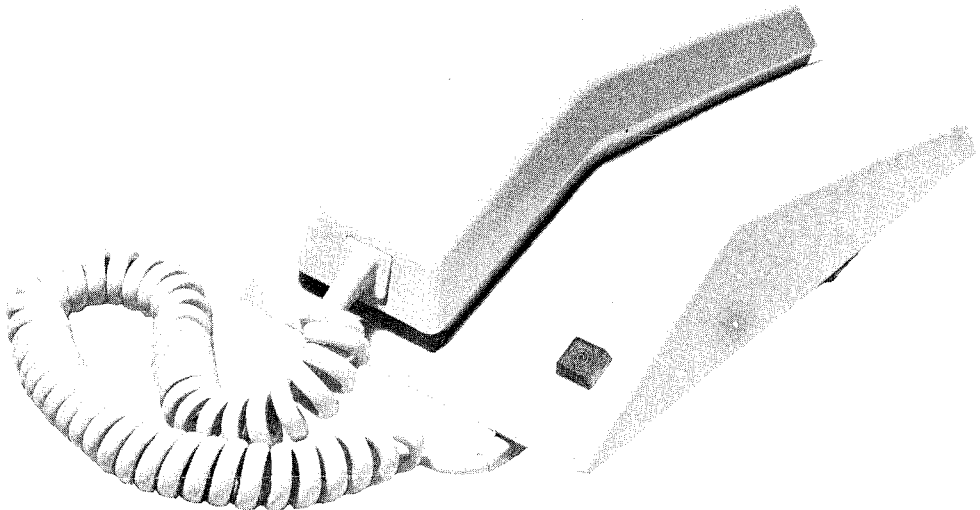


Fig. 1 — Contempra — Message Waiting QSK 100 BX

## **SECTION 502-321-911CA**

### **3. INSTALLATION**

**3.01** The connections for the Message Waiting QSK 100 Telephone Set are shown in Fig. 2. See Section 502-321-910 for installation of the Contempra Telephone Set.

### **4. MAINTENANCE**

**4.01** Replace the message waiting lamp (Kid-5 CM26268) by removing the telephone set housing and replace the lamp in the socket. For the maintenance of other components of the Contempra Telephone Set see Section 502-321-910.

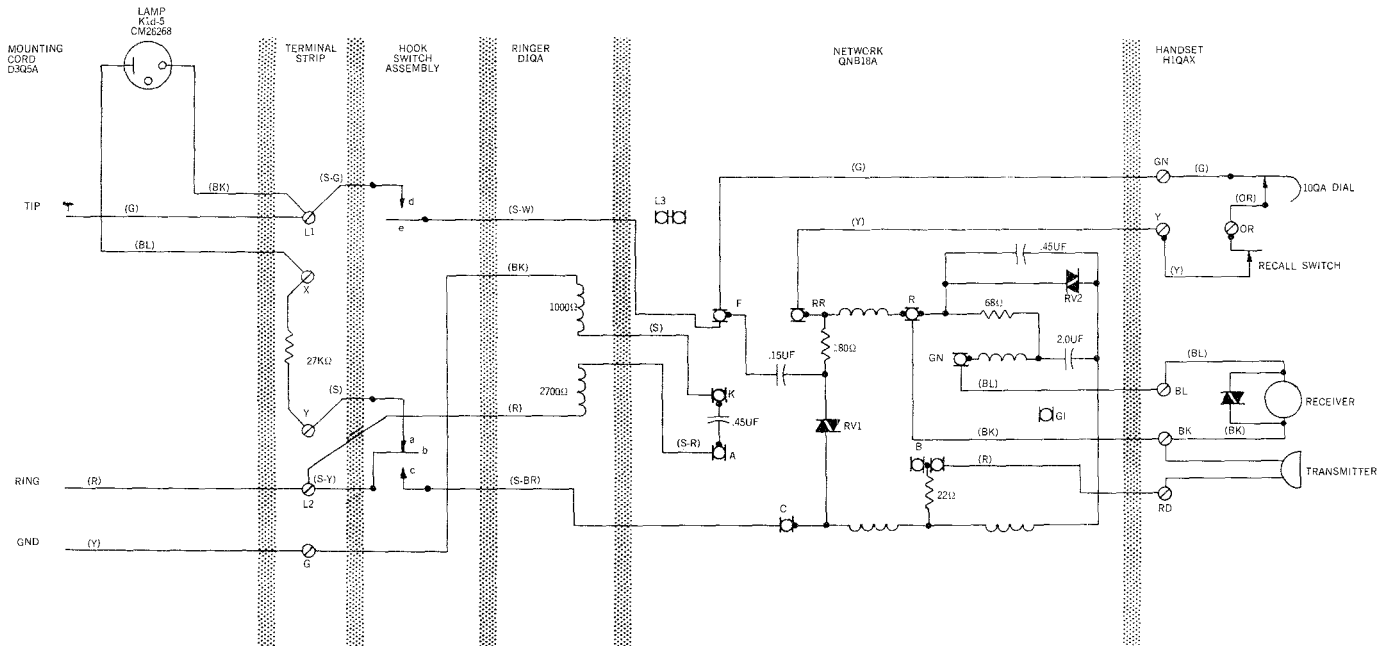
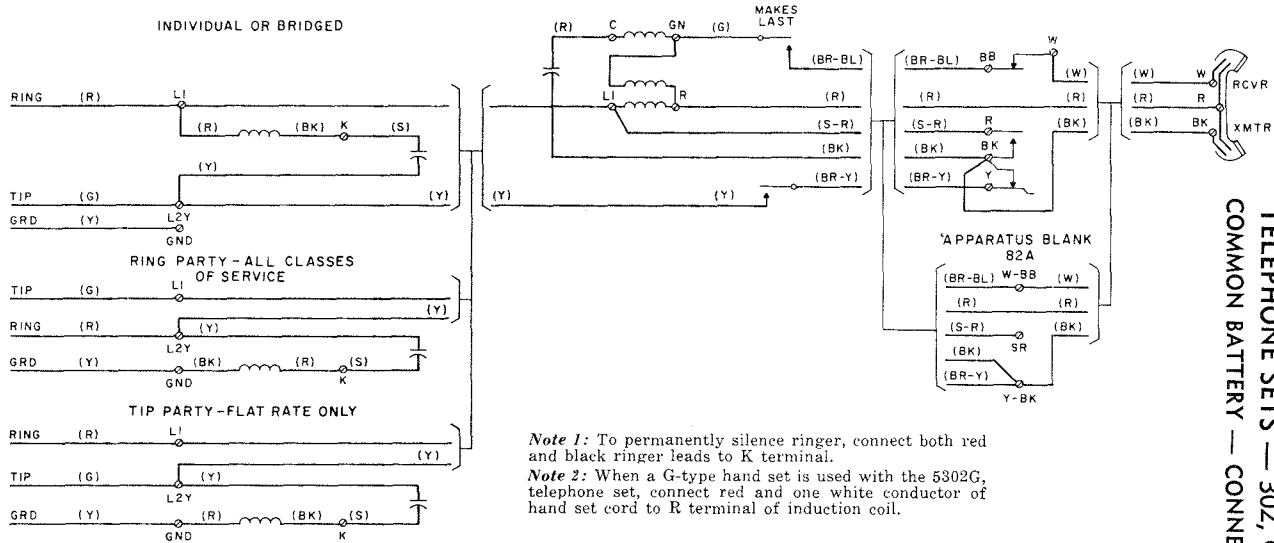


Fig. 2 — QSK 100 BX Schematic



TELEPHONE SETS — 302, G,  
COMMON BATTERY — CONNECTIONS

MOUNTING CORD      RINGER BIAL OR BIA      CAPACITOR 195A      INDUCTION COIL IOIA      SWITCH ASSEMBLY      DIAL 6A, 5H (302) 6H, 5M (5302)      HAND SET FI, F4, OR G



**Note 1:** To permanently silence ringer, connect both red and black ringer leads to K terminal.  
**Note 2:** When a G-type hand set is used with the 5302G, telephone set, connect red and one white conductor of hand set cord to R terminal of induction coil.

TABLE B  
LINE AND RINGER CONNECTIONS

Wire or Lead	Individual or Bridged	Ring Party All Classes of Service	Tip Party Flat Rate
Mounting Cord in Set	R	L1	L1
	G	L2Y	L2Y
	Y	Gnd	Gnd
Ringer Leads	R	L1	K
	BK	K	Gnd
Mounting Cord at Connecting Block	R	R	R
	G	G	G
	Y	Y	Y
Line Wire at Connecting Block	Ring	R	R
	Tip	G	G
	Grd	Y	Y

TABLE A  
FILTER (OPTIONAL)

Type Filter	Filter Leads	Filter Lead Termination
302G	5302G	
61P or 61L	BK	BK of Dial
	Y	Y of Dial
	R	Filter bracket terminal. Also, disconnect BR-Y lead from Y of dial and reconnect to filter bracket terminal.

Fig. 1—302 G, Telephone Sets



## TELEPHONE SETS

### 500 AND 554 TYPES

#### IDENTIFICATION, INSTALLATION AND MAINTENANCE

#### 1. GENERAL

1.01 This section is reissued to:

- Up-date information and include addendum.
- Delete reference to Touch Tone Sets covered in a separate section.
- Add Maintenance information from Section 502-510-300 which is hereby cancelled.

1.02 Selection is covered in the following sections: Station Sets, Common Battery, Selection for General Use and Station Sets, Selection for Specific Use.

1.03 Selection of station apparatus for 1A and 1A1 key telephone systems is shown in the section covering connections for the particular telephone set.

1.04 Description of telephone set components, (i.e., handsets, ringers, networks, and equalizers) may be found in sections pertaining to these items.

1.05 Code numbers, such as 500CR/DR, cover both manual and dial versions of each type of telephone set. This permits converting from dial to manual or manual to dial without changing the code marking. The letter R has been added to indicate that the sets are equipped with spring handset cords. (The R marking has been discontinued on sets of later manufacture).

#### 2. IDENTIFICATION

2.01 The 500- and 554- type telephone sets are for use in common battery areas, manual or dial.

2.02 All parts of the set enclosed by the housing, including the network, line switch (switch-hook), dial, ringer, tube, and cords are mounted on the metal base. The plungers are part of the housing assembly. The housing is fastened to the base with two special round head captive machine screws with lockwashers and can be replaced easily. The network and line switch are riveted to the baseplate and are not to be replaced in the field.

2.03 The 425B Network has been replaced by later models which are identical except that they have additional screw terminals. The later type networks provide for equalization.



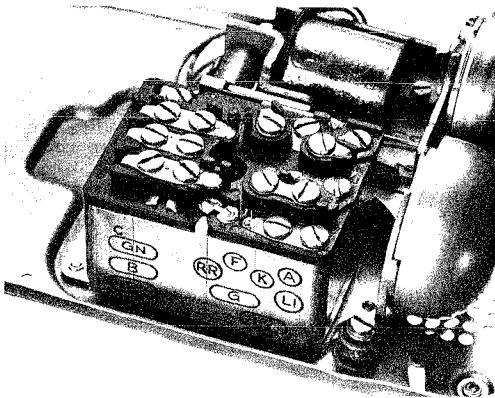
Fig. 1 — 500DR Set, Exterior



**SECTION 502-510-100CA**

**2.04** The card-operated line switch (switch-hook) uses bifurcated springs which are protected by a plastic cover. Since G-type hand sets are too light to operate the switch directly, the necessary force is furnished by a coil spring which is opposed by the contact springs. The handset weight, through lever arms, is required to overcome the force differential between the coil spring and the contact springs.

**2.05** All 500-type telephones are furnished with a 7-type dial. Where required the dial may be replaced, in the field, by an appropriate coloured 95B apparatus blank.

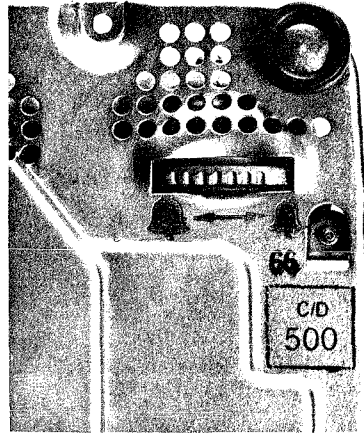


**Fig. 2 — 425E Network**

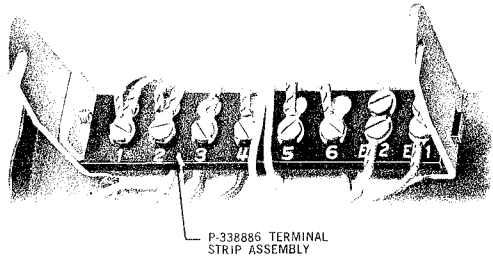
**2.06** All 500- and 554- type sets are manufactured with C4A ringers. The volume of these ringers may be adjusted to one of four levels. (See Fig. 3). A modification can be made to provide bell cutoff when authorized by a Service Order.

**2.07** Provision has been made to mount either a 426A or 425A electron tube to care for conditions of excessive power induction.

**2.08** A code and an assembly date are stamped on the base of each set as shown in Fig. 3.



**Fig. 3 — Base of 500-Type Set**



**Fig. 4 — Terminal Strip**

**2.09 Design Features.**

- (a) The 500 DR is the basic single line set.
- (b) The 500MR telephone set is equipped with a 4-conductor mounting cord and terminal strip (Fig. 4). It is used when a single line station installation is required with a 1A1 key telephone system. The set may also be used at installations which require the ringing circuit

to be brought separately through the mounting cord. The 500MR telephone set is supplied wired for use with the 1A1 key telephone system. Wiring options provide for the ringing circuit to be brought separately through the mounting cord.

(c) The 500FR and 500FRN telephone sets are equipped with a plunger switch and are wired to avoid interference with the dialing or talking of another customer on a divided code ringing line. (See Fig. 5). When the handset is lifted to make a call, only a low-loss receiver circuit is bridged across the line. When it is found that the line is not busy or when an incoming call is to be answered, pulling up the left plunger operates the plunger switch and closes through the talking and/or dialing circuits. Replacing the handset restores the telephone set to normal. Instructions are in English on the 500FR telephone set and in French and English on the 500FRN telephone set.

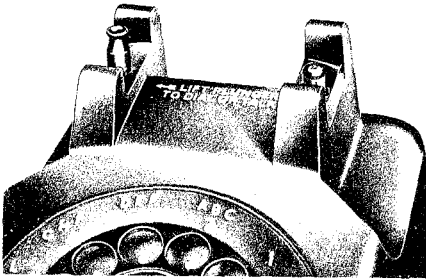


Fig. 5 — 500FR Set

(d) The 500UR sets are equipped with a 584C key and resistor to provide a night light feature with the handset resting in the cradle. When the key is turned to the ON position, the lamp is illuminated at reduced brilliance through the addition of a series resistor in the dial light circuit. When the handset is lifted from the cradle, the switchhook contacts shunt the night light switch and resistor, and full brilliance is obtained from the lamp. With the 584C key in the normal position, illumination is provided only when the handset is removed from the cradle. (See Fig. 6). A 6- to 8-volt ac power

supply must be provided by means of a transformer to light the dial lamp.

(e) The 500WR/YR telephone sets are equipped with a lamp to provide a message-waiting feature (see Fig. 7). They are arranged to receive and hold a visual signal under control of an attendant at a PBX. General application for this feature is in a hotel or motel; however, it can be provided for any station under the control of an attendant. The message-waiting lamp cap is red or amber with a metal insert which provides tongs for engagement with retaining rings in the housing. The lamp is a GE NE 51 which protrudes through the housing into the cap. The lamp cap assembly is LP-11E-100 or #26XP281193 (amber). The words MESSAGE WAITING PHONE are stamped on the bottom of all 500W/YR telephone sets.

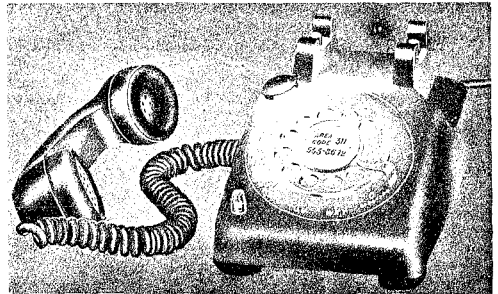


Fig. 6 — 500UR Set

Both 500WR (without dial) and 500YR (with dial) telephone sets, are available on order. However, when advantageous, these sets may be converted to include a dial, and vice versa, in the field.

(f) The 554-type telephone set is designed for wall mounting. With the exception of the switchhook, components are interchangeable with components of 500-type telephone sets. (See Figs. 9 and 10). The housing of the 554-type telephone set is designed as a handset hanger (see Fig. 8).

**SECTION 502-510-100CA**

The switchhook on coloured 554-type telephone sets is chrome plated (P-12E433) and the dial is a 7C that matches the set. Black 554-type telephone sets of current manufacture have a (P-96B637) black plastic switchhook and a black 7C dial. The black plastic switchhook and

black 7C dial are also provided on certain repaired sets. The (P-96B637) switchhook and black 7C dial have replaced the chrome switchhook and 7D dial that were provided on black 554-type sets.



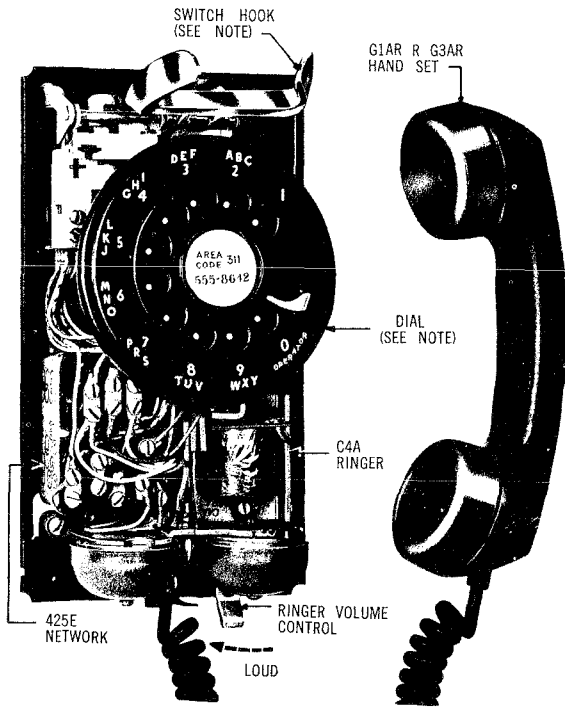
**Fig. 7 — 500YR Set**



**Fig. 8 — 554-Type Set, Housing Handset Rest**



**Fig. 9 — 554BR Exterior**



NOTE: THE TYPE OF SWITCHHOOK AND DIAL ARE COVERED IN PARA. 2.09 (f).

Fig. 10 — 554BR Set, Interior

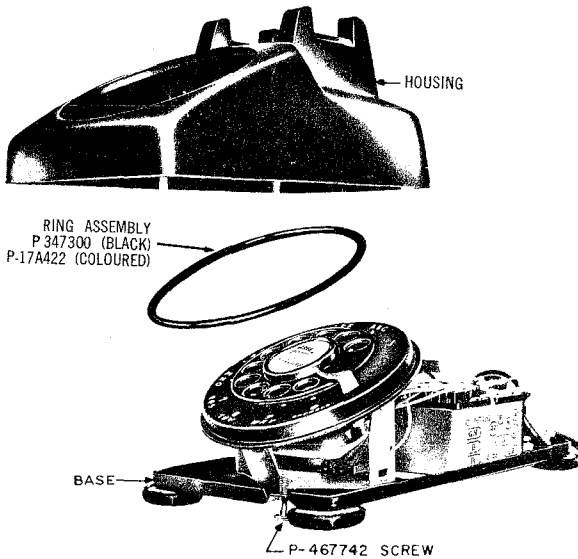


Fig. 11 — 500-Type Set, Housing Assembly

3. INSTALLATION

(a) Housings:

(1) The housing on all 500-type desk sets is secured to the base by two captive mounting screws with lockwashers under the head (see Fig. 11).

(2) To remove housing on wall-type telephone sets, push inward on tab of snap fastener located in the cord slot and, while the tab is depressed, lift the lower part of the housing outward and upward, releasing fastener catch and disengaging latch opening assembly (see Fig. 12 and 13). To replace, slip housing over switchhook and dial, engage the latch spring assembly, then press firmly on lower part of housing to engage snap fastener and catch (see Fig. 14).

(b) Mounting Wall Sets:

(1) Several holes are provided in the baseplate for more flexibility in mounting to minimize backboard use. The telephone set may be mounted directly over a conduit outlet box. (See Fig. 15).

(2) Early production sets have a baseplate which does not provide the proper hole arrangement for fastening directly to conduit outlet boxes as shown in Fig. 15 therefore when required, drill two holes on the baseplate as shown in Fig. 16, using a No. 17 drill point of an Automatic B Push-Drill. An alternate method is to mount the set with wall screw anchors of proper size using the mounting holes at the top and bottom of the baseplate.

(3) Refer to appropriate Section for information on fasteners suitable for mounting wall-type sets directly to wall surfaces.

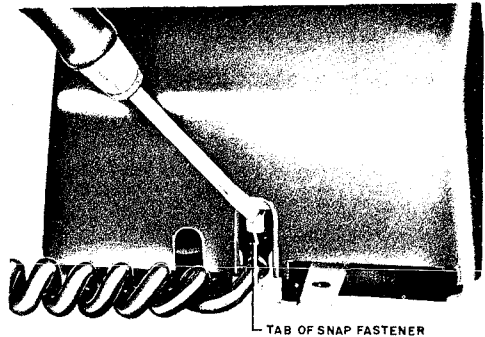


Fig. 12 — Wall-Type Telephone Set, Method of Removing Housing

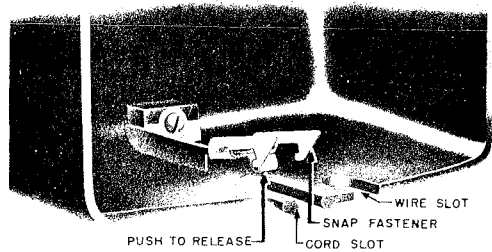


Fig. 13 — 554-Type Set, Cover Interior

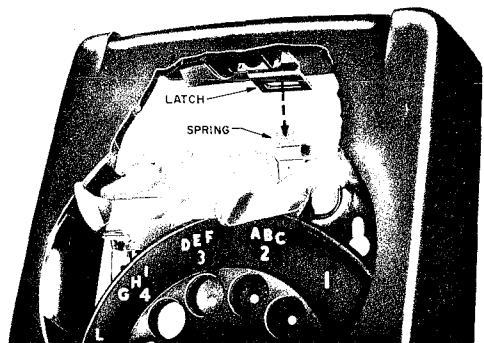


Fig. 14 — Wall-Type Telephone Set, Method of Replacing Housing

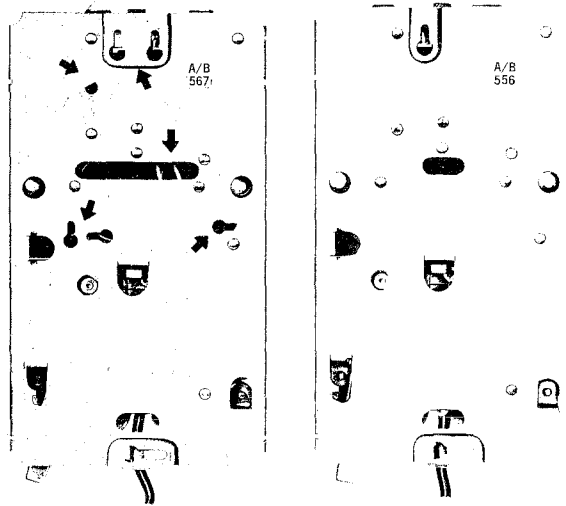


Fig. 15 — Present and Early Production Baseplates

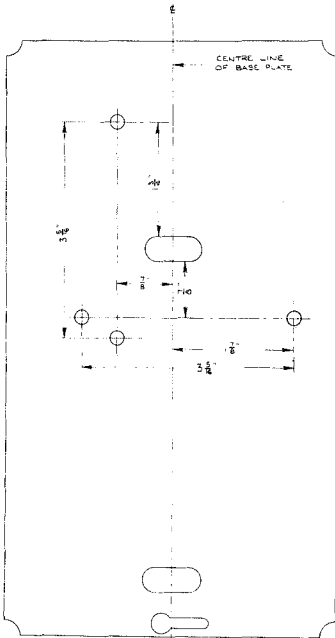


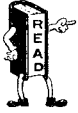
Fig. 16 — Early Production 554 Tel. Set Baseplate Mounting Holes Drilling Location



Fig. 17 — 500-Type Housing with 95B Apparatus Blank Exterior

(c) **Mounting Cords:**

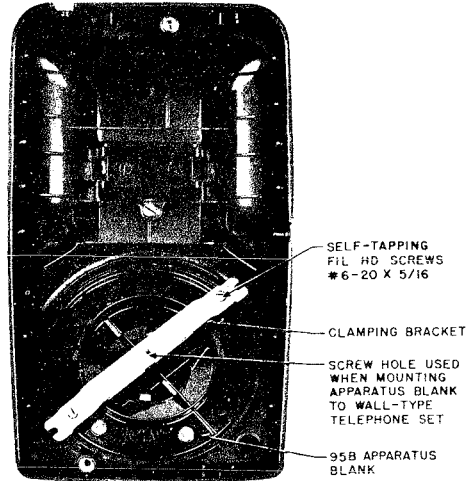
*Spade tips or skinned wires should contact only the terminal to which the connection is made. Electrical contact with the metal tab of the network housing may cause the exposed dial finger stop or handset hook on wall sets to become energized with ringing voltage or dc line voltage.*



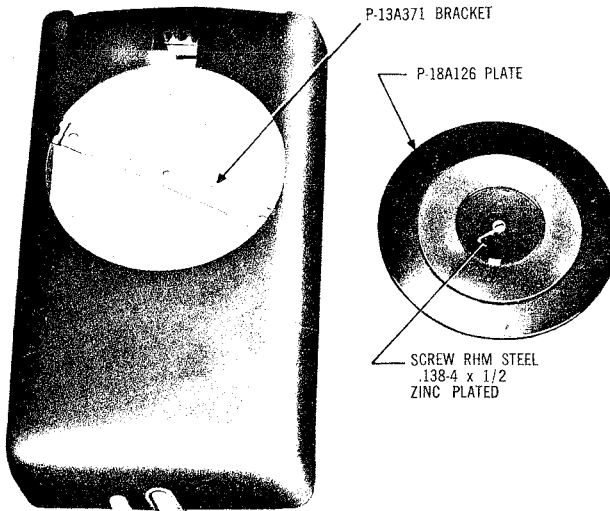
- Dress cord leads to avoid interference with moving parts and ringer gongs.

Three conductor mounting cords may be given a twist (after terminating) before anchoring, to prevent slack from touching ringer gongs.

(d) **Apparatus Blanks:** Figs. 17 and 18 show front and rear views of the 95B apparatus blank assembly in a 500-type desk set. Figs. 19 and 20, show assembly of the 95B apparatus blank in a 554-type set. Note that bracket position is inverted when used on 554-type sets.



**Fig. 18 — 500-Type Housing with 95B Apparatus Blank, Interior**



**Fig. 19 — 554-Type Housing with 95B Apparatus Blank, Exterior**

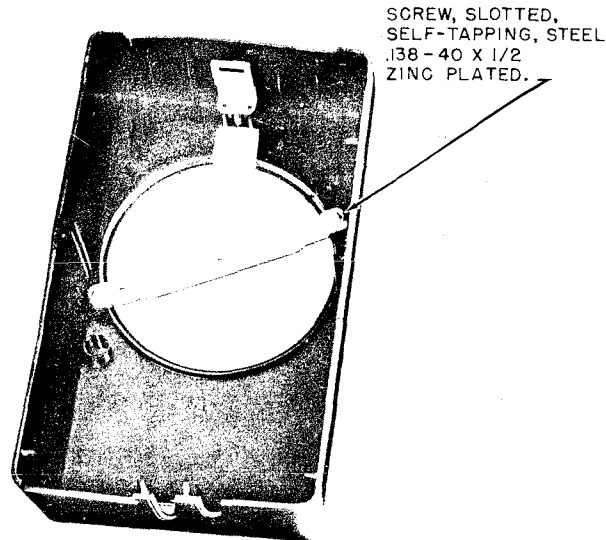


Fig. 20 — 554-Type Housing, Interior

(e) *Ringer:*

(1) Two washer head mounting screws placed through rubber grommets hold the ringer on base of set (see Fig. 21).

(2) The ringer volume-control lever in the 554-type telephone sets is riveted at one end to the base of the set (see Fig. 22). In the 500-type telephone set, the ringer volume-control assembly is part of the ringer.

(3) Cord leads should be dressed to avoid interference with moving parts and ringer gongs. On the 500-type set, anchor the mounting cord beneath the stay hook in the right rear corner of the base to prevent interference with the ringer gong.

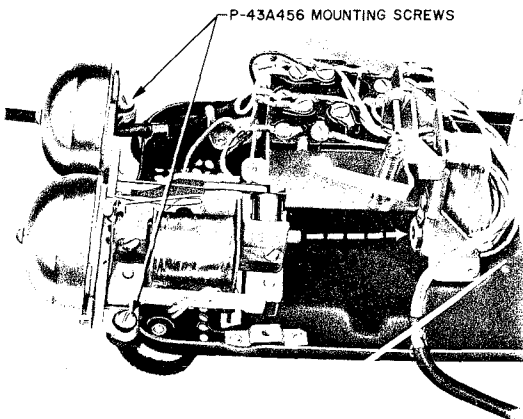


Fig. 21 — 500-Type Set, Ringer Assembly

(f) *Handset:* All 500 and 1500 series telephone sets are equipped with G-type handsets. The handsets may be replaced by a handset containing an amplifier such as the G6AR handset for customers with impaired hearing or the G7AR for customers with impaired speech. A G8Q1A handset can be used in noisy locations.



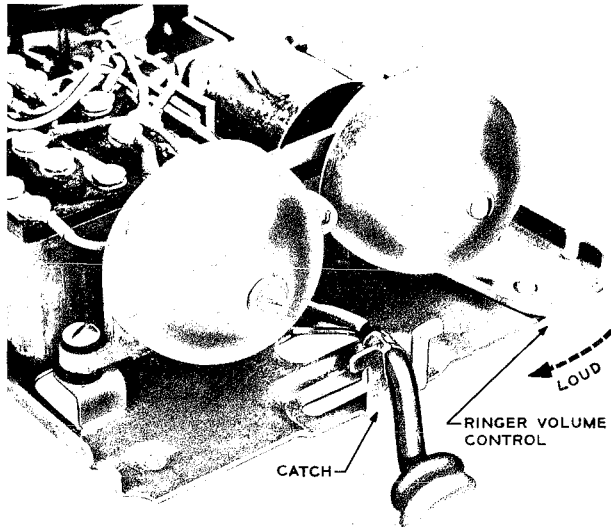


Fig. 22 — 554-Type Set, Ringer Volume-Control Lever

**4. MAINTENANCE**

**4.01** Inspect exterior and interior of the sets for obvious defects such as loose, displaced, or broken parts. Check also for obstruction of moving parts or the presence of foreign matter that may interfere with the proper operation of the set.

**4.02** A KS-8035 Friction Pad is available for use on telephone sets equipped with leather feet. The pad has adhesive on one side which is covered by a removable fabric.

**4.03** If it is necessary to instruct a customer in a method of cleaning his telephone set, suggest wiping with a cloth slightly dampened in a common household detergent. The set should then be immediately dried by wiping with a clean cloth. The customer should be warned not to allow excessive moisture to penetrate the dial, receiver, transmitter and switch-hook areas. Under no circumstances should any other type of cleaning agent be used to clean a telephone set. Many wax and cleaning agents contain silicone oil which will damage plastic housing and set components.

**4.04** Check line and ground terminations before determining trouble causes from Table A.

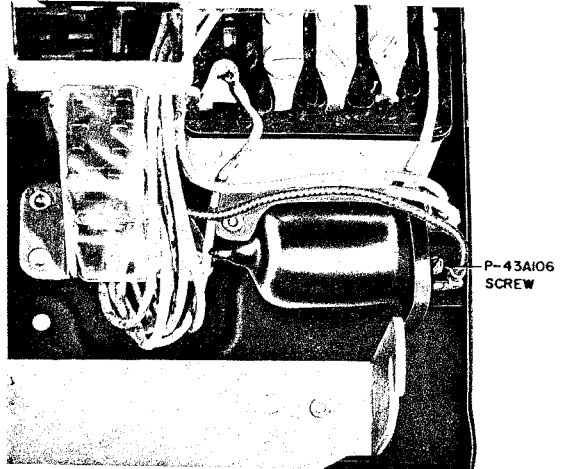


Fig. 23 — 500-Type Set Showing Tube Mounting

**TABLE A**  
**TROUBLES, PROBABLE CAUSES, AND CORRECTIVE MEASURES**

Trouble	Probable Cause	Corrective Measure
Bell Does Not Ring	Ringer disconnected or incorrectly wired in set.	Connect correctly.
	Volume control wheel in cut-off position.	Move control wheel to ring position.
	Open winding.	Replace ringer.
	Metal particles in armature gap.	Remove with Scotch tape or approved equivalent.
	Open tube.	Short-circuit yellow and black tube leads. If ringer operates when ringing voltage of correct polarity is applied, replace tube.
Bell Too Loud	Volume control wheel in wrong position.	Move control wheel to softer position and advise customer on proper use.
Bell Too Soft	Volume control wheel in wrong position.	Move control wheel to louder position and advise customer on proper use.
	Set on sound-absorbent material.	Place set on hard surface.
	Cord touching gong.	Dress cord properly.
Bell Taps While Dialing or Operating Switch	Incorrect wiring.	Check mounting cord and ringer connections.
	Loose gong.	Tighten screw as required.
Bell Rings When Other Party Is Called: Cross Ring or False Ring	Incorrect wiring.	Check mounting cord and ringer connections.
	Biasing tension too low.	Place bias spring in high tension notch. If ringer still cross-rings, replace ringer.
Bell Keeps Ringing When Handset Is Removed	Open handset cord or dial pulse contacts.	Replace handset cord or dial.
	Defective network or open set wiring.	Replace set.
	Line contacts on switch do not close.	Check switch cover and ears. Ears should fit into notches.
No Dial Tone or Set Dead	Open mounting cord or handset cord.	Replace cord.
	Defective receiver unit or varistor shorted.	Replace receiver unit.
	Dial pulse contacts open or off-normal shunt contacts closed.	Replace dial.
(Continued on Page 12)		

**TABLE A (Cont)**  
**TROUBLES, PROBABLE CAUSES, AND CORRECTIVE MEASURES**

Trouble	Probable Cause	Corrective Measure
No Dial Tone or Set Dead	Open induction coil.	Replace telephone set.
	Switch contacts do not operate.	Check switch cover for proper installation.
Cannot Break Dial Tone	Dial pulse contacts do not open.	Replace dial.
	Dial filter capacitor shorted.	Replace telephone set.
Loud Clicks While Dialing	Dial off-normal shunt contacts do not close.	Replace dial.
Cannot Hear	Open or shorted receiver unit or handset cord.	Replace receiver unit or handset cord.
	Dial off-normal shunt contacts closed.	Replace dial.
	Open induction coil or network.	Replace telephone set.
	Switch receiver contacts do not open.	Check switch cover for interference.
Cannot Be Heard	Defective transmitter or open handset cord.	Replace transmitter or handset cord.
High Sidetone	Defective sidetone balancing network.	Replace telephone set.
Dial Lamp Does Not Light	Lamp burned out.	Replace lamp.
	Transformer plug is out of receptacle.	Replace plug.
	Defective transformer.	Replace transformer.
	No power at ac receptacle.	Check with customer for possible blown fuse or for a power-control switch.

**4.05 Electrical Maintenance****(a) Tube Assembly**

- 425A, 4-element tube may be substituted for 426A, to care for cases of excessive power induction. See section on inductive noise.
- Tube assembly is held to base of set with single screw (Fig. 23).
- Wall type telephone mounting is shown in Fig. 24.

**4.06 Mechanical Maintenance:****(a) Plungers**

- Should move freely throughout entire travel without binding or squeaking.
- Accessible when handhold cover is removed (Fig. 25).
- Clean with KS-2423 cloth moistened with KS-7860 petroleum spirits and lubricate with a No. 2 or softer graphite pencil.

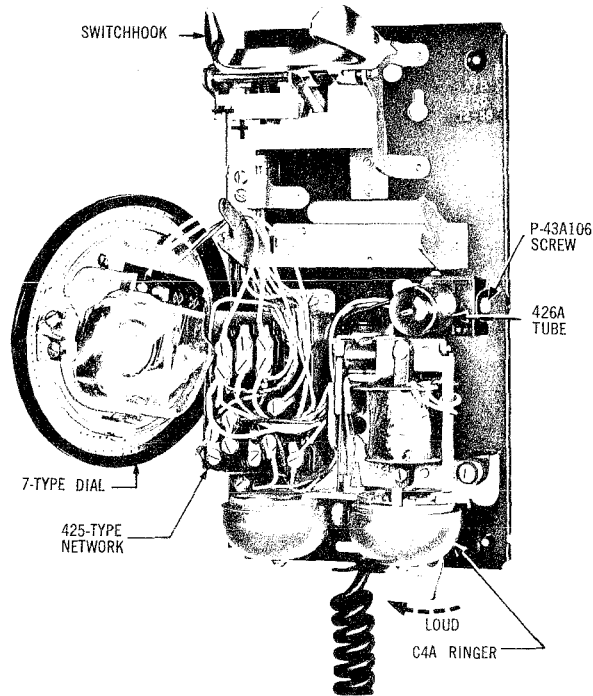


Fig. 24 — Wall Type Telephone  
Showing Tube Mounting

- Replace housing if plungers do not move freely after cleaning and lubricating.

with a No. 2 or softer graphite pencil (Fig. 26 and 27).

(b) *Plunger Switch Assembly*

- If left-hand plunger fails to lock when pulled upward to extreme position, replace set.
- No field maintenance shall be performed other than cleaning.

(c) *Operating Bracket Switch Assembly*

- Should function throughout entire travel without binding or squeaking.
- Clean bosses on operating bracket arms, spring anchor points, operating bracket, and shaft bearing points with KS-2423 cloth moistened in KS-7860 petroleum spirits and lubricate bearing surfaces

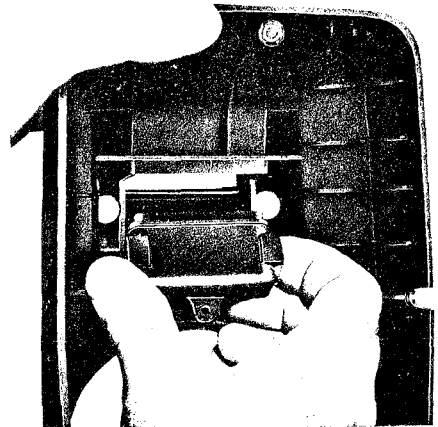


Fig. 25 — Handhole Cover

SECTION 502-510-100CA

(d) *Switch Contacts*

- (1) Line Switch: Remove line switch cover by depressing slides between thumb and index finger and tilting cover up and away from mounting. Clean contacts with 265C tool.
- (2) 584C Key (500U and 501U telephone sets only) — clean contacts of key with 265C tool.

(e) *Switchhook Assembly*

- (1) Do not perform any field maintenance other than replacing cover and cleaning contacts, except as noted in 4 to 6 below.
- (2) Remove switchhook cover by depressing sides between thumb and index finger and tilting cover up and away from mounting (Fig. 31).
- (3) Replace set if any other trouble is encountered in switchhook assembly, except as noted in 4 to 6 below.

**Hookswitch Operating Card**

- (4) Some trouble has been experienced with breakage of the operating card on wall mounted telephones and to a lesser extent on desk telephones. A new card P-339685 has been developed to reduce this trouble. The new card, which is easily identified because of its white colour, is now used on all 500-type telephones of new manufacture.
- (5) When breakage occurs on wall mounted telephones or desk telephones with multi-conductor cords it will generally be found more economical to change the broken operating card than to replace the telephone. No attempt shall be made to replace stationary cards in the field.
- (6) A visual inspection, before removal of the broken card, will reveal the placement of the springs in the card fingers. Exercise care when removing broken card and placing new card. Do not bend or deform the contact springs. Examine the

assembly for correct contact sequence before replacing switch cover. If contact springs are damaged or stationary card is broken replace telephone.

- (f) *Dial Light*: to remove, turn lamp cap and lamp counterclockwise (Fig. 28) and lift out.

**500NN/PN**

- When operator rings, with the special cord, lamp lights.

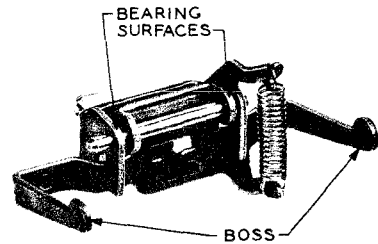


Fig. 26 — Operating Bracket Switch Assembly  
500 Type Telephone Sets

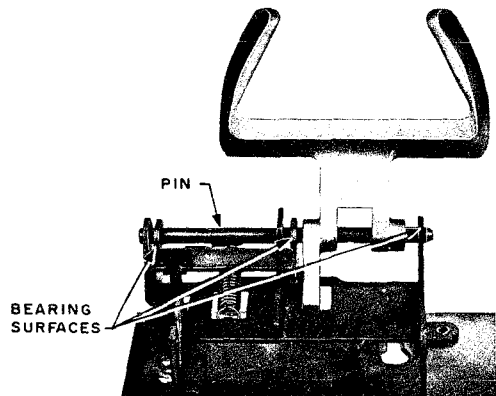


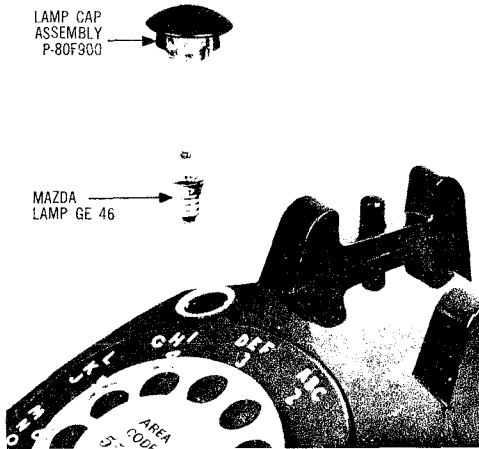
Fig. 27 — Handset Hook Assembly  
554 Type Telephone Sets

- These telephones require an 1820A Lamp and a 26-XP28-1196 Lamp Cap Assembly.

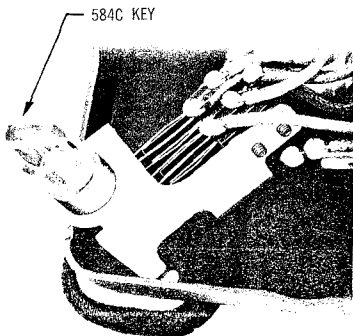
**500U**

- When handset is lifted the dial lamp should light. With the 584C key (see Fig. 29) turned lamp should light. If not see Table A and check line switch or key contacts.

**Lamp Assembly Shown in Fig. 28.**

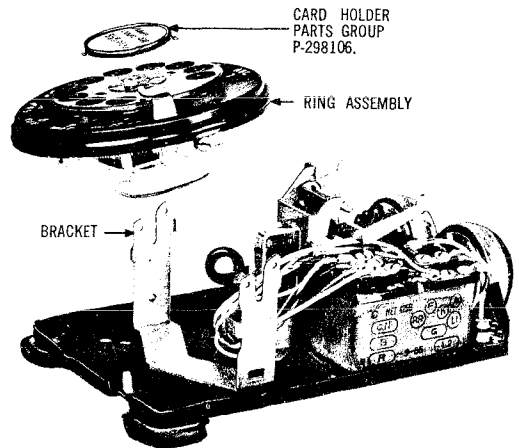


**Fig. 28 — Lamp Assembly, 500UR Set**



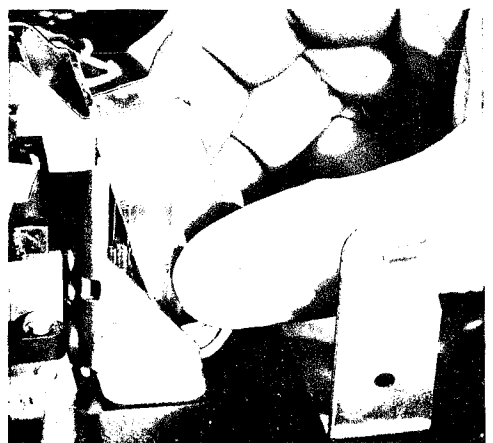
**Fig. 29 — 584C Key**

- (g) **Dial Assembly** (Fig. 30) : The dial is attached to the dial mounting bracket with two or three screws. The current-type dial bracket assembly does not have a front mounting attachment.



**Fig. 30 — Dial Assembly**

- (h) **Other Components**: For maintenance of handsets, dials, and ringers refer to the sections covering these components.



**Fig. 31 — Removing Switch-Cover Assembly**



## TELEPHONE SETS

1500 (M.D.), 1554 (M.D.), 2500 & 2554

### IDENTIFICATION, INSTALLATION, AND MAINTENANCE

#### 1. GENERAL

**1.01** This section is issued to include all general purpose TOUCH-TONE dial desk and wall-type, telephone sets in one section.

**1.02** This section contains information formerly found in Sections 502-510-100 and 502-510-300.

#### 2. IDENTIFICATION

**2.01** The difference between the 1500 and 2500 Type Sets is that the 1500 is equipped with a 10 button TOUCH-TONE® Dial while the 2500 has a 12 button TOUCH-TONE® Dial. All other features exist in both sets.

**2.02** The 2500 and 2554 Type TOUCH-TONE Telephone Sets supersede the 1500- and 1554-Type TOUCH-TONE Telephone Sets which are Manufacture Discontinued.

**2.03** The 2500- and 2554-Type Sets are equipped with the 12-button (35 type) TOUCH-TONE dial. The extra buttons, one marked with an asterisk (\*), the other with a number sign (#), are located respectively to the left and right side of the "0" button.

**2.04** These extra buttons are operational but their application, at this time, is restricted to end-to-end signalling.

**2.05** Sets equipped with 12-button (35 type) TOUCH-TONE Dials are directly interchangeable with sets equipped with 10-button (25 type) TOUCH-TONE Dials. No additional wiring is required.

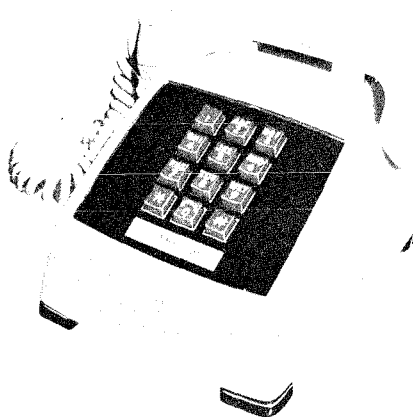


Fig. 1 — 2500 Type Telephone Set

**2.06** The 1500- and 1554-Type Sets are equipped with 25-Type TOUCH-TONE Dials.

#### 1500 TOUCH TONE Telephone Set

**2.07** The 1500-Type TOUCH-TONE Set (Fig. 2) is basically the same as the 500-Type Set except that the dial mounting bracket and set housing have been modified to accommodate the 25-Type TOUCH-TONE Dial. The dial assembly contains a line powered oscillator which generates two frequencies when a button is depressed. These frequencies are transmitted to the central office which must be equipped with a converter.



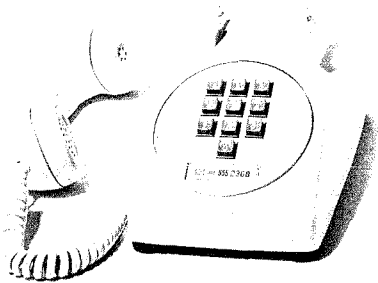


Fig. 2 – 1500 Type Telephone Set

The converter accepts the oscillator signals and translates them into a 2-out-of-5 code for crossbar offices or dial pulses for step-by-step offices.

**1554 TOUCH-TONE Wall Telephone Set**

2.08 The 1554 Wall Telephone Set (Fig. 3) is the TOUCH-TONE version of the 554 Telephone Set.

**TABLE A**  
**COLOUR**

HOUSING, HANDSET, CORD AND MATCHING FACEPLATE COLOUR		FACEPLATE COORDINATED COLOUR	
Black	(—03)	Charcoal	(—70)
Ivory	(—50)	Muted Ivory	(—80)
Green	(—51)	Light Green	(—71)
Red	(—53)	Muted Red	(—69)
White	(—53)	Light Gray	(—73)
Light Beige	(—60)	Muted Beige	(—75)



Fig. 3 – 1554 Wall Telephone Set

*Note:* The 2554 Wall Telephone Set uses the same base and housing but is equipped with a 35-Type TOUCH-TONE dial.

2.09 **Application:** CO, PBX, 1A1 and 1A2 Telephone System Line Circuits.

**2.10 Colour**

- Sets are furnished in standard telephone apparatus colour as shown in Table A.

**3. INSTALLATION**

Use standard procedures.

## 4. MAINTENANCE

4.01 Maintenance procedures for the 1500- and 2500- Type Sets are similar to those for 500-Type Sets.

(a) Maintenance of the telephone sets consists of cleaning exterior surfaces, burnishing and adjusting key contacts, and replacing defective components.

(b) Housings, handset, and dial pushbuttons can be cleaned with a clean KS-2423 cloth moistened with water. Do not use scouring powders or cleaners. Replace coloured sets if cleaning procedures do not result in a satisfactory appearance.

(c) Inspect exterior and interior surfaces of the set for obvious defects such as broken, loose, or displaced parts. Check for obstruction of moving parts or the presence of foreign material that may interfere with the proper operation of the set.

(d) Check line and ground terminations and wiring dress before proceeding with maintenance procedures.

(e) Maintenance of handsets, dials, and ringers is outlined in sections covering these components.

(f) Networks and line switch assemblies are riveted to the baseplate and no attempt should be made to replace them in the field. If defective, replace complete telephone set.

### Plungers

4.02 Plungers should move freely throughout entire travel without binding or squeaking. They are accessible from the underside of the housing when the handhold cover is removed.



*Do not perform any field maintenance other than replacing cover, cleaning contacts, and lubricating bearing points.*

4.03 Remove switch cover by depressing sides between thumb and index finger and tilting cover away from mounting.

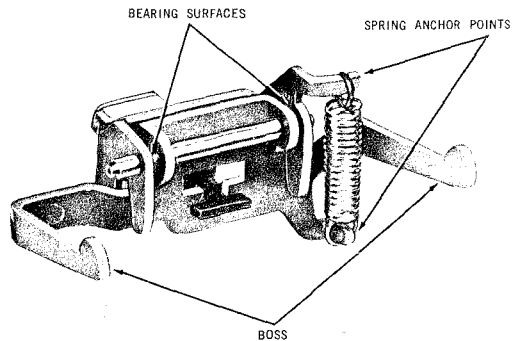


Fig. 4 — Line Switch Assembly

4.04 The operating bracket assembly should function without binding. To eliminate any binding or squeaking, clean bosses on operating bracket arms, spring anchor points, operating brackets, shaft bearing points, and pins with a KS-2423 cloth moistened with KS-7860 petroleum spirits. Lubricate bearing surfaces (Fig. 4) with a No. 2 or softer graphite pencil.

### Dial, 25 and 35 Type

4.05 If no tones are heard when a dial button is depressed, check line polarity.



*Do not attempt repair of TOUCH-TONE® dials in the field. Replace dial.*

*The 25 or 35-Type Dial will function only when the orange-black dial lead is negative (—) and the green lead is positive (+).*

4.06 To check dial, place receiver to the ear. Two tones should be heard when any button is depressed. Dial tone should break when button is released.

4.07 If no tones are heard, check line polarity to the dial. If line polarity is correct, replace dial. Use a 1011 Type Test Set across line terminations to test other components in the telephone set.

SECTION 502-510-121CA

4.08 A modified dial bracket and terminal strip associated with the 25-Type Dial in the 1500 Telephone Set, is shown in Fig. 5.

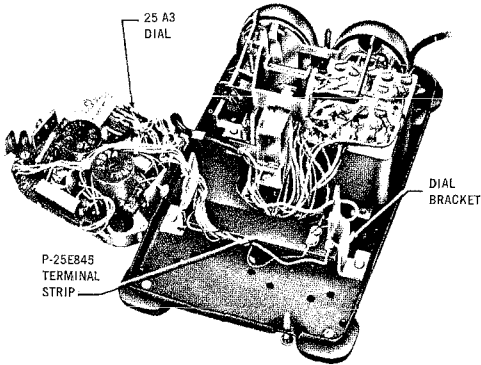


Fig. 5 — 1500 Telephone Set, Interior

5. REPLACEABLE APPARATUS

(Refer to Table B)

REPLACEMENT COMPONENTS

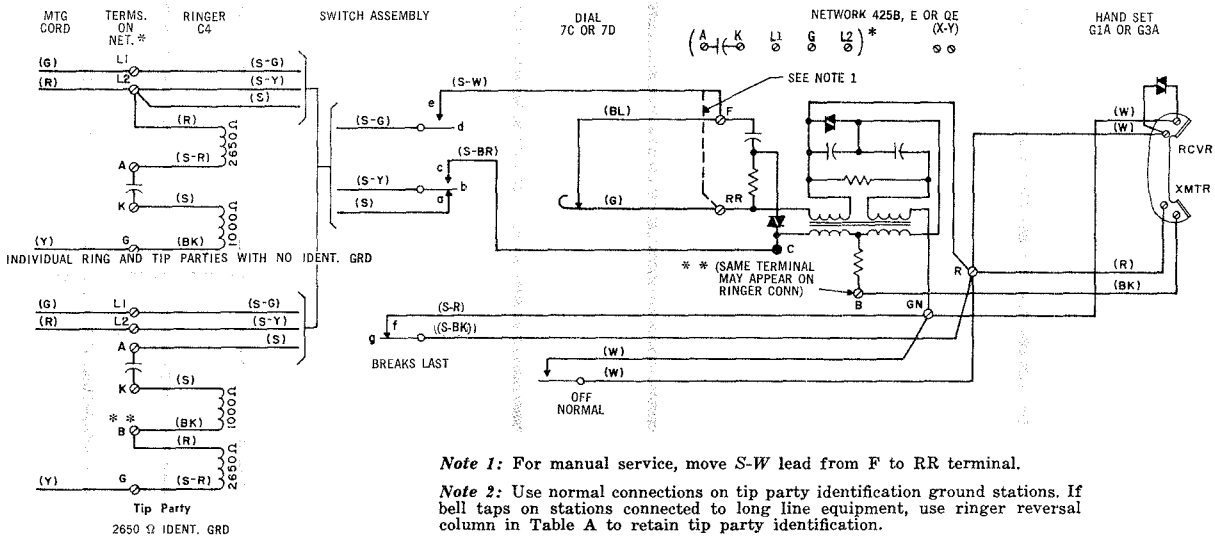
TABLE B

COMPONENT	2500D	1500D
Dial	35A3 or 35Q3A	25A3
Faceplate	P8972*	86D5*
Housing	P-83A3*	
Number Card Window	P-896334	
Ringer	C4A	
Mounting Cord	D3EN*	
Set Hand	G3AR*	
Cord, Set Hand	H4CJ*	

\*Add 2 Digit colour code see Table A.

5.01 *Number Card Holder*: To remove the number card holder use the KS-16750 Type Releaser.

TELEPHONE SETS — 500C, D  
CONNECTIONS



**Note 1:** For manual service, move S-W lead from F to RR terminal.

**Note 2:** Use normal connections on tip party identification ground stations. If bell taps on stations connected to long line equipment, use ringer reversal column in Table A to retain tip party identification.

\*\* Same terminals may appear on ringer connection.

TABLE A  
LINE AND RINGER CONNECTIONS

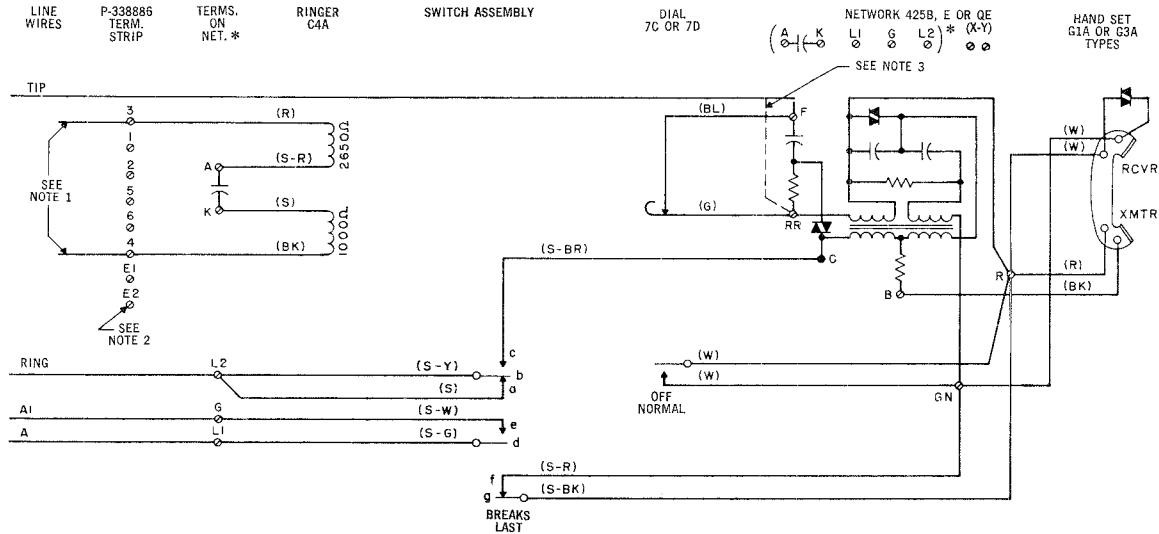
Wire or Lead		Individual or Bridged	Ring Party	Tip Party No Ident. Grd.	Tip Party Ident. Grd. 2650 Ω		
					Normal Conn.	Ringer Reverse	Ringer Silenced
Ringer Leads	R	L2	L2	L2	B	G	B
	BK	G	G	G	B	K	K
	S	K	K	K	K	B	K
	S-R	A	A	A	G	B	G
Switchhook Lead	S	L2	L2	L2	A	A	L2
Mounting Cord in Set	R	L2	L2	L2	L2	L2	L2
	G	L1	L1	L1	L1	L1	L1
	Y	G	G	G	G	G	G
Mounting Cord at Connecting Block	R	R	R	G	G	G	G
	G	G	G	R	R	R	R
	Y	G	Y	Y	Y	Y	Y
Line Wire at Connecting Block	Ring	R	R	R	R	R	R
	Tip	G	G	G	G	G	G
	Grd	Y	Y	Y	Y	Y	Y

To silence ringer for all classes of service except tip party, ground identification, connect yellow mounting cord to same terminal as red mounting cord lead at connecting block.

Fig. 1 — 500C, D Telephone Set



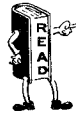
Spade tips or skinned wires should come in contact only with terminal to which connection is made. Electrical contact with metal tab of the network housing may cause the exposed dial finger stop to become energized with ringing current or dc line current.



**Note 1:** To tip and ring for individual line ringer or to common audible signal leads from equipment cabinet.

**Note 2:** Mount PO 338886 terminal strip with PO-338888 retainer and PO 43A376 screws. If the above are not available, connect ringer leads with D-161488 connectors. Tape and store to avoid mechanical interference.

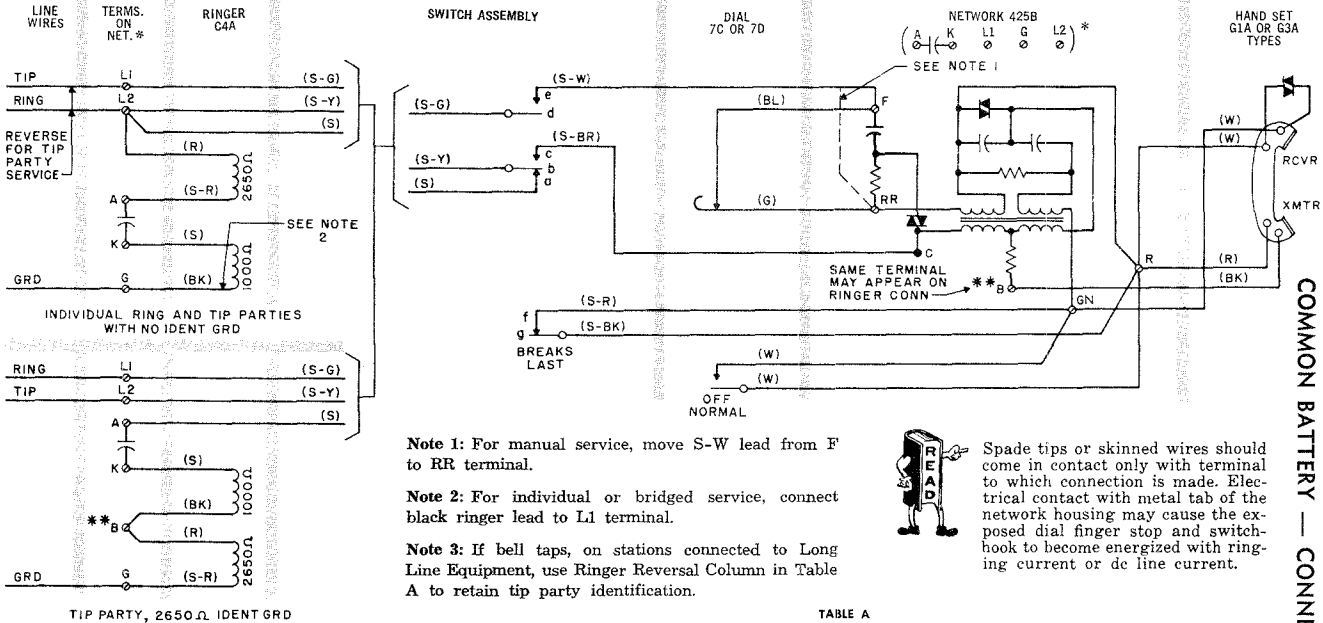
**Note 3:** For manual service, connect tip of line to RR terminal of network.



To prevent false holding condition when handset is restored, switch contacts **cb** must break before **de** breaks.

**Fig. 2 — 500C,D Telephone Set Rewired for A Lead Control**

TELEPHONE SETS 554B  
COMMON BATTERY — CONNECTIONS



**Note 1:** For manual service, move S-W lead from F to RR terminal.

**Note 2:** For individual or bridged service, connect black ringer lead to L1 terminal.

**Note 3:** If bell taps, on stations connected to Long Line Equipment, use Ringer Reversal Column in Table A to retain tip party identification.



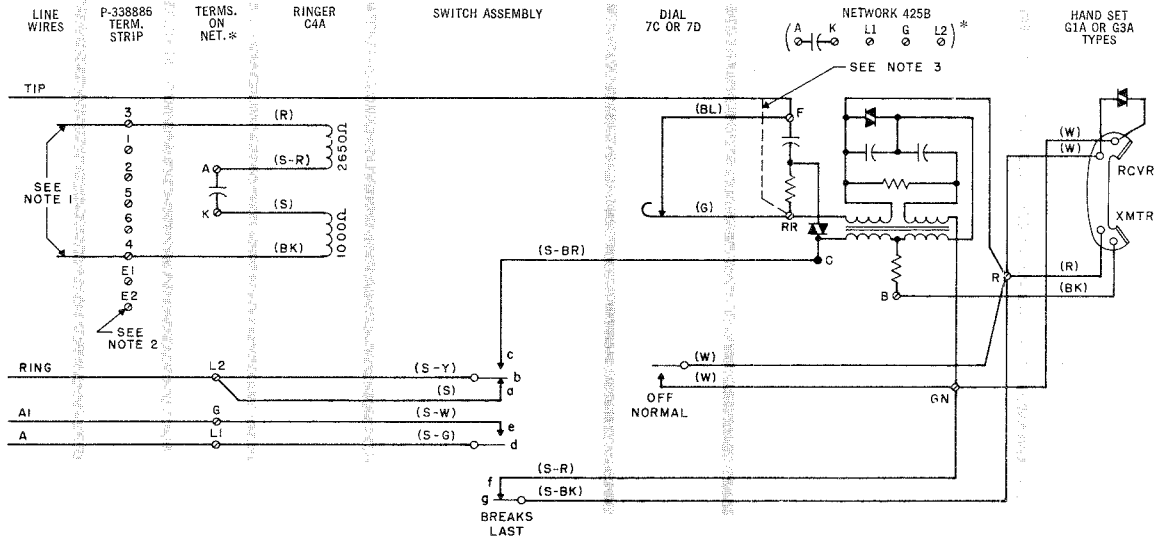
Spade tips or skinned wires should come in contact only with terminal to which connection is made. Electrical contact with metal tab of the network housing may cause the exposed dial finger stop and switchhook to become energized with ringing current or dc line current.

TABLE A  
LINE AND RINGER CONNECTIONS

Wire or Lead	Individual or Bridged	Ring Party	Tip Party No Ident Ground	Tip Party Ident Ground			
				Normal Connections	Ringer Reverse (Note 3)	To Silence Ringer Permanently	
				2650Ω		2650Ω	
Ringer Leads	R	L2	L2	L2	B	G	B
	BK	L1	G	G	B	K	K
	S	K	K	K	K	B	K
	S-R	A	A	A	G	B	G
Switchhook Lead	S	L2	L2	L2	A	A	L2
Line Wire in Set	Ring	R	L2	L2	L1	L1	L1
	Tip	G	L1	L1	L2	L2	L2
	Grd	Y	G	G	G	G	G

To silence ringer for all classes of service except tip party ground identification, connect S and BK ringer leads on K terminal of 425B network.

Fig. 1 — 554B Telephone Set



**Note 1:** To tip and ring for individual line ringer or to common audible signal leads from equipment cabinet.

**Note 2:** Mount PO 338886 terminal strip with PO 338888 retainer and PO 43A376 screws. If the above are not available, connect ringer leads with D-161488 connectors. Tape and store to avoid mechanical interference.

**Note 3:** For manual service, connect tip of line to RR terminal of network.



To prevent false holding condition when handset is restored, switch contacts *cb* must break before *de* breaks.

Fig. 2 — 554B Telephone Set Rewired for A Lead Control

TELEPHONE SETS — 1500D, 2500D, 1554B AND 2554B  
CONNECTIONS



**TABLE A**  
**LINE AND RINGER CONNECTIONS**

Wire or Lead		▽ Individual or Bridged	▽ Ring Party	Tip Party	
				(X) No Idfy. Grd.	Identifying Ground #2650Ω
Mounting Cord In Set	R	L2	L2	L2	L2
	G	L1	L1	L1	L1
	Y	G	G	G	G
Ringer Leads	R	L2	L2	L2	B
	BK	G	G	G	B
	S	K	K	K	K
	S-R	A	A	A	G
Switchhook Leads	S	L2	L2	L2	A
	S-W	RR	RR	C	C †
	S-BR	C	C	RR	RR †
Mounting Cord At Connecting Block	R	R	R	G	G
	G	G	G	R	R
	Y	G	Y	Y	Y
Line Wire at Connecting Block or In Set	Ring	R	R	R	R
	Tip	G	G	G	G
	Grd	Y	Y	Y	Y

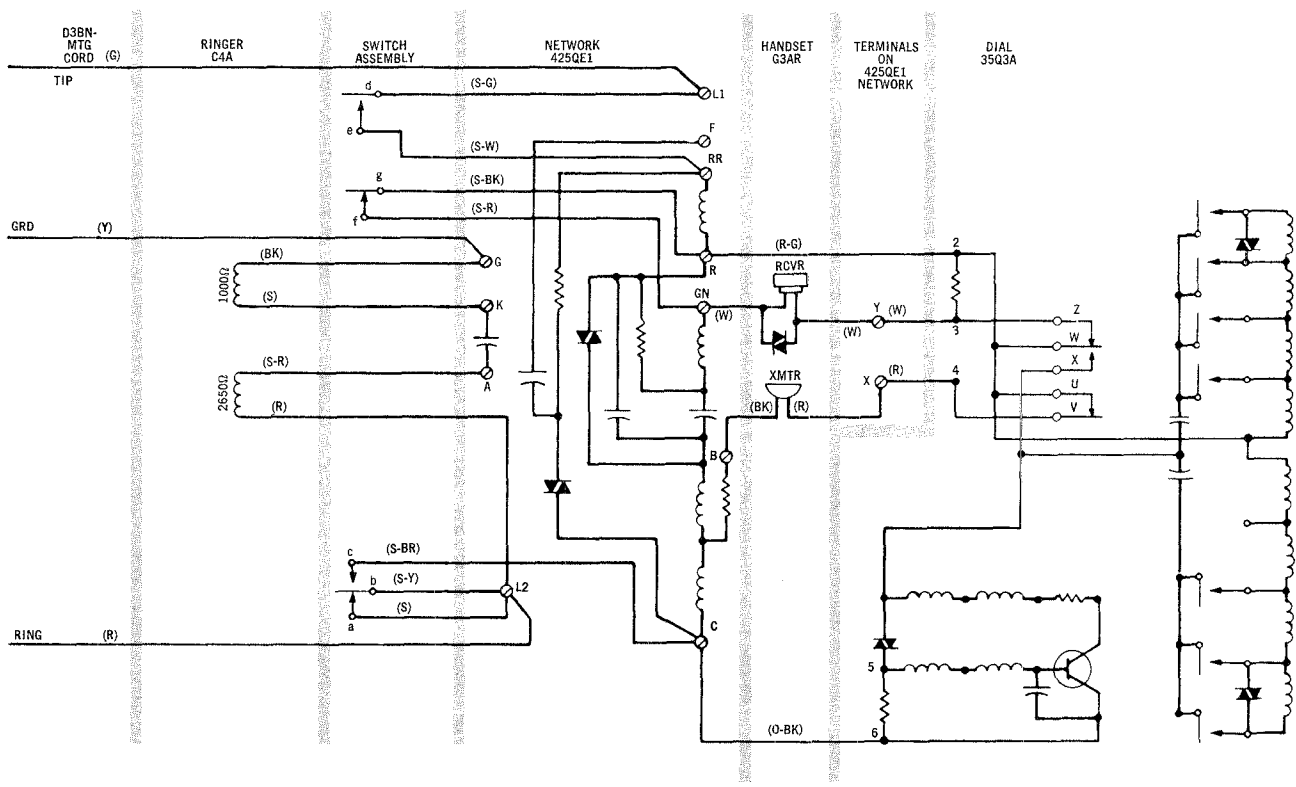


Fig. 1 — 1500D, 2500D and 2554B Telephone Sets, Connections with 35Q3A Dial

**TABLE B**  
**LINE AND RINGER CONNECTIONS**

Wire or Lead			▽ Individual or Bridged
Mounting Cord In Set		R	L2
		G	RR
		Y	L1
		BK	G
Ringer Leads		R	L2
		BK	RR
		S	K
		S-R	A
Switchhook Leads		S	L2
		S-W	G
		S-BR	C
Mounting Cord At Connecting Block		R	R
		G	G
		Y	Y
		BK	BK
Line wire at Connecting Block or In Set	Ring	R	L2
	Tip	G	RR
	A	Y	L1
	A1	BK	G

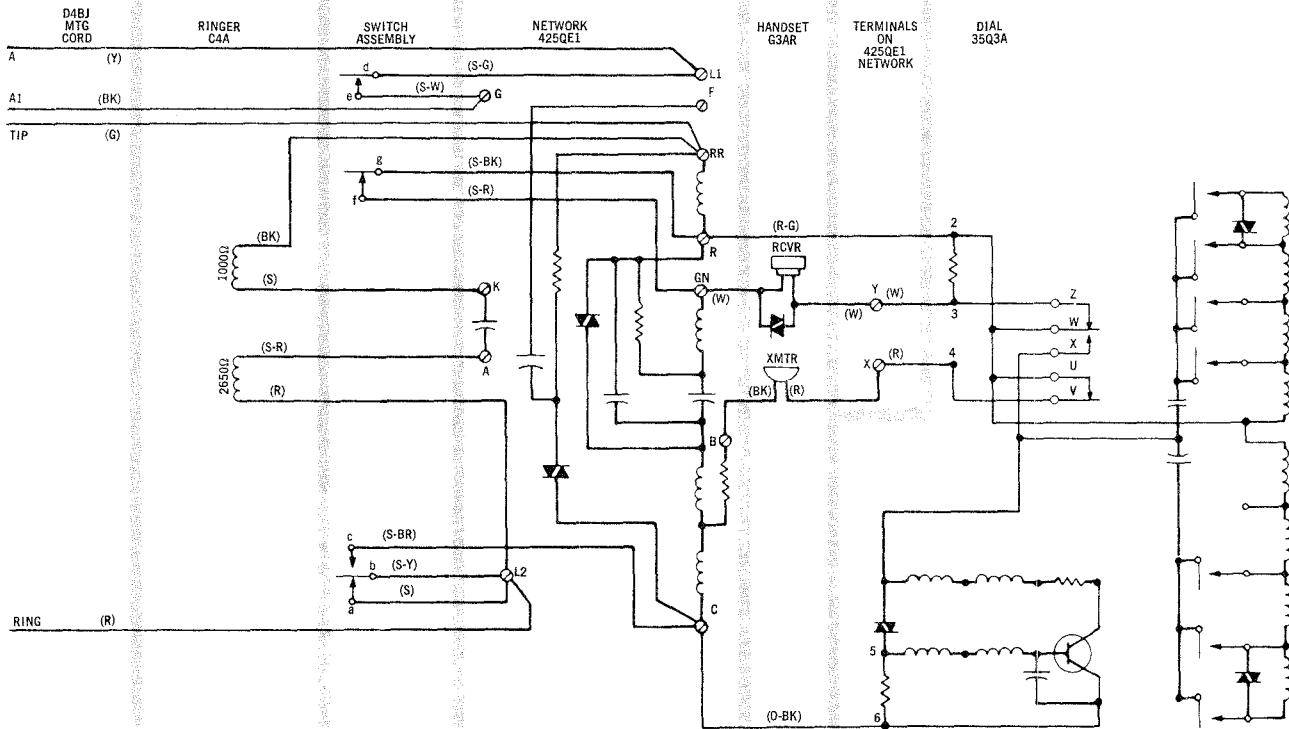


Fig. 2 — 1500D, 2500D, 1554B and 2554B Telephone Sets Rewired for "A" Lead Control Connections With 35Q3A Dial

**TABLE C**  
**LINE AND RINGER CONNECTIONS**

Wire or Lead		▽ Individual or Bridged	▽ Ring Party	Tip Party	
				(X) No Idfy. Grd.	Identifying Ground #2650Ω
Mounting Cord In Set	R	L2	L2	L2	L2
	G	L1	L1	L1	L1
	Y	G	G	G	G
Ringer Leads	R	L2	L2	L2	B
	BK	G	G	G	B
	S	K	K	K	K
Switchhook Leads	S-R	A	A	A	G
	S	L2	L2	L2	A
	S-W	F	F	C	C †
Mounting Cord At Connecting Block	S-BR	C	C	F	F †
	R	R	R	G	G
	G	G	G	R	R
Line Wire at Connecting Block	Y	G	Y	Y	Y
	Ring	R	R	R	R
	Tip	G	G	G	G
	Grd.	Y	Y	Y	Y

**TABLE D**  
**RINGER LEAD CONNECTIONS**  
**TO SILENCE RINGER PERMANENTLY**

Tip Party Identifying Ground	Ringer Lead			
	Red	Black	Slate	S Red
OHMS				
2650	B	K	K	G
For all classes of service except that listed above.				
Connect yellow mounting cord lead to same terminal as red mounting cord lead at Connecting Block.				

**NOTES:**

- SET TO BE WIRED AS SHOWN IN CONNECTING DIAGRAM (INDIVIDUAL OR BRIDGED AND RING PARTY).
- RINGER CUT-OFF CONTROL BY CUSTOMER:  
BEND STOP NEXT TO DETENT OR RINGER VOLUME CONTROL SO THAT IT COMPLETELY CLEARS THE RIM OF THE RINGER FRAME. THIS PROVIDES A FURTHER POSITION ON VOLUME CONTROL WHICH PREVENTS ARMATURE MOVEMENT.
- WHEN THE HANDSET IS REMOVED FROM THE CRADLE, CONTACT GF BREAKS LAST.
- IN TABLE A AND C, CONNECTIONS FOR INDIVIDUAL OR BRIDGED AND RING PARTIES ARE FOR FLAT AND MESSAGE RATE SERVICE.
- (X) IN TABLE A AND C, CONNECTIONS ARE FOR TIP PARTY EXCEPT MESSAGE RATE.
- WHERE DIFFICULTY IS EXPERIENCED IN REVERSING THESE LEADS, USE QCM9A CONNECTORS AND MIW CORDS TO LENGTHEN THEM.
- IN TABLE A AND C, CONNECTIONS ARE FOR STEP-BY-STEP WITH AUTOMATIC TICKETING, STEP-BY-STEP WITH AUTOMATIC MESSAGE ACCOUNTING AND MODIFIED CROSSBAR WITH AUTOMATIC MESSAGE ACCOUNTING.

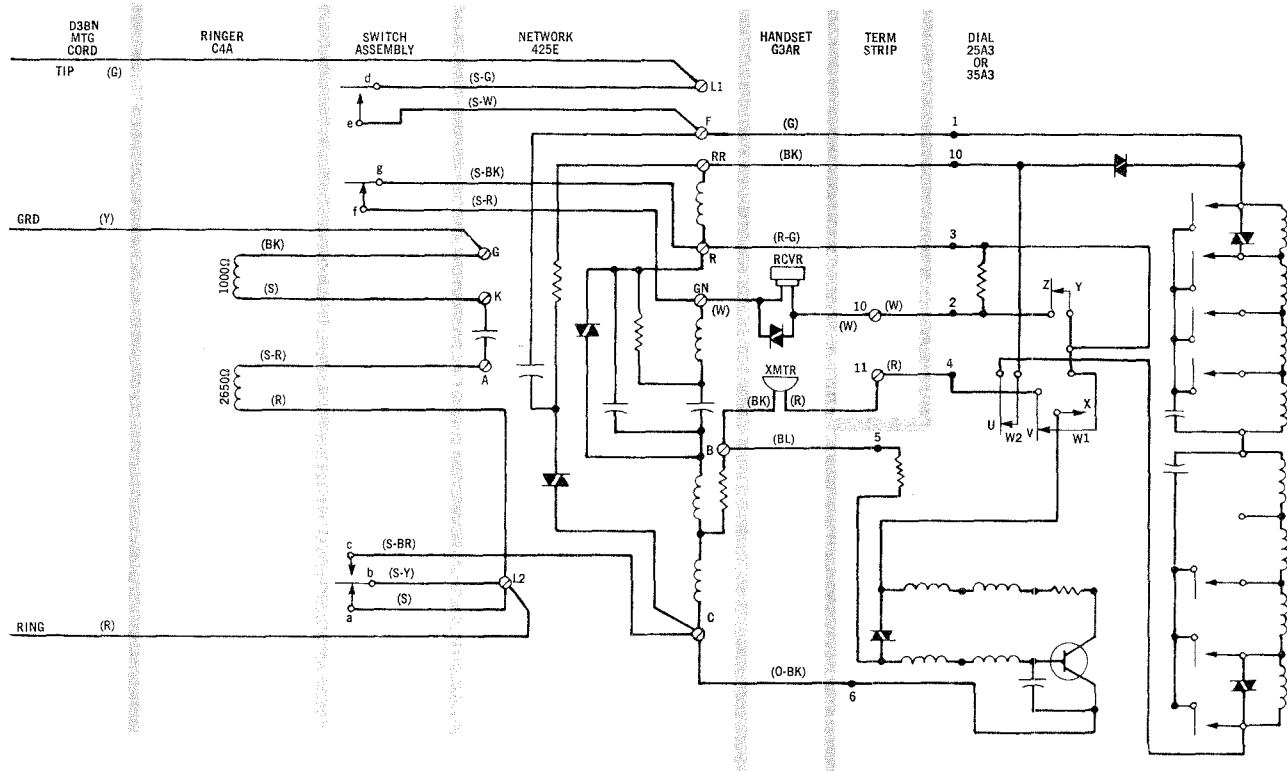


Fig. 3 — 1500D, 2500D, 1554B and 2554B Telephone Sets. Connections With 25A3 or 35A3 Dial. (M.D.)

**TABLE E**  
**LINE AND RINGER CONNECTIONS**

Wire or Lead			▽ Individual or Bridged
Mounting Cord In Set		R	L2
		G	F
		Y	L1
		BK	G
Ringer Leads		R	L2
		BK	F
		S	K
		S-R	A
Switchhook Leads		S	L2
		S-W	G
		S-BR	C
Mounting Cord At Connecting Block		R	R
		G	G
		Y	Y
		BK	BK
Line Wire at Connecting Block or In Set	Ring	R	L2
	Tip	G	F
	A	Y	L1
	A1	BK	G

**NOTES:**

1. SET TO BE WIRED AS SHOWN IN CONNECTING DIAGRAM (INDIVIDUAL OR BRIDGED AND RING PARTY).
  2. RINGER CUT-OFF CONTROL BY CUSTOMER: BEND STOP NEXT TO DETENT OR RINGER VOLUME CONTROL SO THAT IT COMPLETELY CLEARS THE RIM OF THE RINGER FRAME. THIS PROVIDES A FURTHER POSITION ON VOLUME CONTROL WHICH PREVENTS ARMATURE MOVEMENT.
  3. WHEN THE HANDSET IS REMOVED FROM THE CRADLE, CONTACT GF BREAKS LAST.
- ▽ IN TABLE E, CONNECTIONS FOR INDIVIDUAL OR BRIDGED PARTIES ARE FOR FLAT AND MESSAGE RATE SERVICE.
4. TO SILENCE RINGER PERMANENTLY, TERMINATE BK RINGER LEAD ON TERMINAL K OF NETWORK.

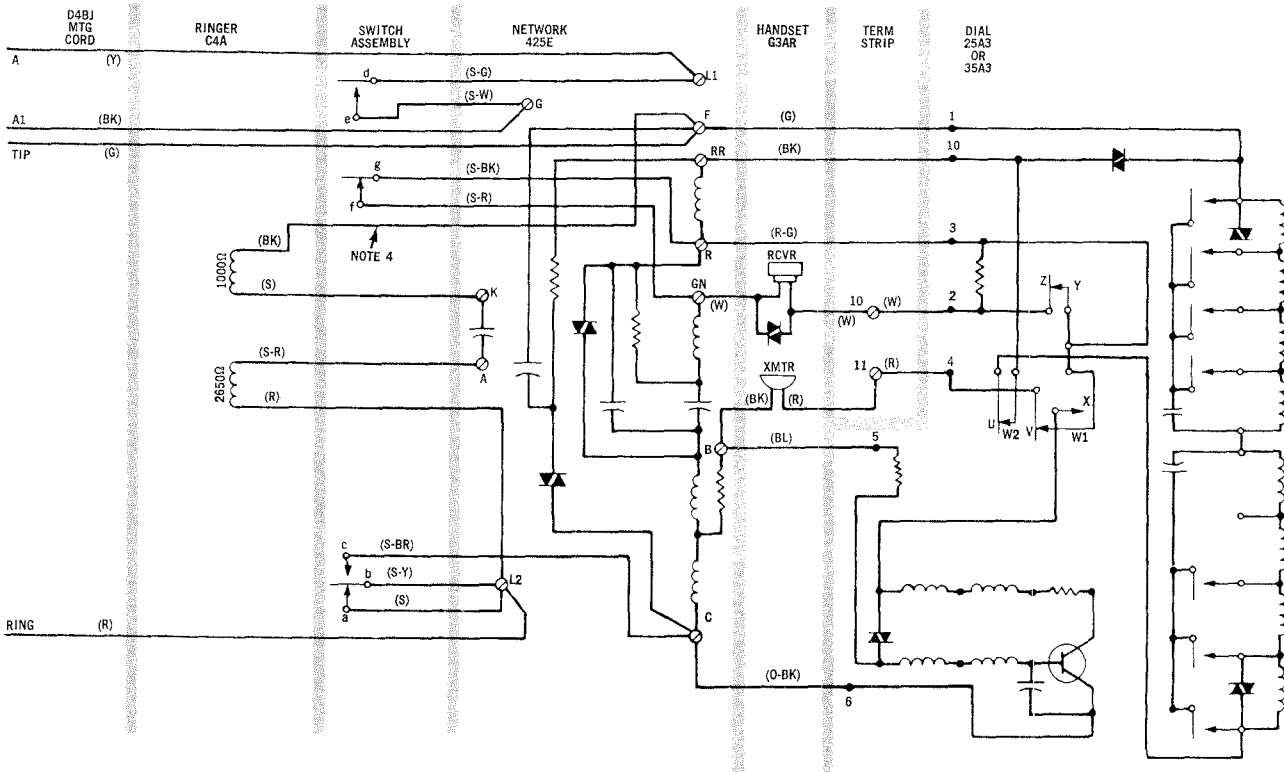


Fig. 4 — 1500D, 2500D, 1554B and 2554B Telephone Sets. Connections With 25A3 or 35A3 Dial. Rewired for "A" Lead Control.





**TELEPHONE SETS**  
**1511 DQA (M.D.) 2511 DQA TYPES**  
**IDENTIFICATION, INSTALLATION, AND MAINTENANCE**

**1. IDENTIFICATION**

**1.01** The difference between 1511 and 2511 type sets is that the 1511 is equipped with a 10 button TOUCH-TONE® dial while the 2511 has a 12 button TOUCH-TONE® dial. All other features exist in both sets.

**1.02** This section is reissued to include information on the 35Q3B dial.

**ORDERING GUIDE**

Set Telephone 2511 DQA\*.

**TABLE A**  
**REPLACEABLE COMPONENTS**

Component	2511 DQA	1511 DQA
Dial	35Q3B	35B3 (MD) 25B3
Faceplate		P8973* P8993*
Housing		P-83A3*
Number Card Window		P-896334
Ringer		C4A
Exclusion Switch		P-19A410
Term. Strip & Key Assembly		P-89029
Mounting Cord		D16QA*
Set Hand		G3AR*
Cord, Set Hand		H4CJ*

\* Add 2 digit colour code see Table B.

**DESIGN FEATURES**

- Exclusion Switch
- 2 Line Pickup
- Signalling

**APPLICATION**

CO, PBX, 1A1 and 1A2 telephone system line circuits.

**COLOUR**

2511 Type Set

- Sets are furnished in standard telephone apparatus colour with coordinated colour faceplates as shown in Table B.

1511 Type Set

- Sets are furnished in standard telephone apparatus colour and matching faceplates.

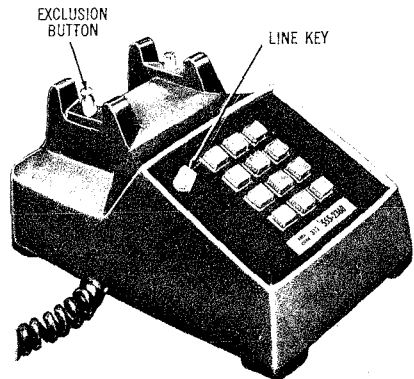


Fig. 1 — 2511 DQA Telephone Set

**TABLE B**  
**COLOUR**

Housing, Handset, Cord		Faceplate Coordinated Colour	
Black	(—03)	Charcoal	(—70)
Ivory	(—50)	Muted Ivory	(—80)
Green	(—51)	Light Green	(—71)
Red	(—53)	Muted Red	(—69)
White	(—58)	Light Gray	(—73)
Light Beige	(—60)	Muted Beige	(—75)

## OPERATING FEATURES

- **Exclusion switch**—pull up left-hand line switch plunger to cutoff extension stations.
- **Line pickup key**—turnbutton portion of key. Turn to connect talking circuit to either of two lines as desired.
- **Signalling key**—pushbutton portion of line pickup key. Depress to activate external signalling device, if provided.

## 2. INSTALLATION

Use Standard Procedures.

## 3. MAINTENANCE

- (a) Maintenance of 1500 and 2500-series telephone sets consist of cleaning exterior surfaces, burnishing and adjusting key contacts, and replacing defective components.
- (b) Housings, handset, and dial pushbuttons can be cleaned with a clean KS-2423 cloth moistened with water. Do not use scouring powders or cleaners. Replace coloured sets if cleaning procedures do not result in a satisfactory appearance.
- (c) Inspect exterior and interior surfaces of the set for obvious defects such as broken, loose or displaced parts. Check for obstruction of moving parts or the presence of foreign material that may interfere with the proper operation of the set.
- (d) Check line and ground terminations and wiring dress before proceeding with maintenance procedures.
- (e) Maintenance of handsets, dials, and ringers is outlined in sections covering these components.
- (f) Networks and line switch assemblies are riveted to the baseplate and no attempt should be made to replace them in the field. If defective, replace complete telephone set.

## EXCLUSION SWITCH AND PLUNGER UNIT



*Do not perform any field maintenance other than cleaning contacts with a 265C tool.*

## 3.01 The exclusion plunger shall:

- (a) Remain in operated position when pulled up to the full extent of its stroke.
- (b) Return to fully depressed position when the handset is placed on the cradle.
- (c) Drop by its own weight from the mid position to the fully depressed position when the right plunger is depressed.

## 3.02 With set housing removed:

- (a) Normally closed contacts of exclusion switch shall have perceptible follow when the switch is operated manually.
- (b) Normally open contacts shall have a minimum separation of 0.015 inch; gauge by eye. The thickness of three sheets of a Bell System Practice is approximately 0.015 inch.

## 3.03 Replace set if exclusion switch fails to meet these requirements.

## TURNBUTTON/PUSHBUTTON KEY



*Adjust this key only if replacement of the complete telephone set is impracticable.*

## 3.04 Use a 363 tool to adjust key. Be sure there is adequate light. Pay particular attention to turnbutton contact operating sequence. If any adjustment is made on the contact springs, recheck all requirements applicable to the key. If springs cannot be adjusted, replace the telephone set.

## 3.05 Requirements of the key include:

- (a) The pushbutton shall operate freely in either turnbutton position and return to normal after being depressed to the limit of its stroke.

- (b) When plunger is fully depressed, there shall be perceptible clearance between bottom pushbutton contacts and set baseplate.
- (c) Contacts for turnbutton operation shall not be made or broken by operation of the plunger as a pushbutton.
- (d) The pushbutton contacts shall have a minimum separation of 0.030 inch. Gauge by eye.
- (e) It shall not be possible to make or break the contacts by any side thrust against the plunger in either the operated or unoperated position.
- (f) All springs, including those which make when the key is unoperated, shall have perceptible follow (approximately 0.010 inch).
- (g) All normally closed contacts shall break before any normally open contact makes.
- (h) Normally closed turnbutton contacts shall have a break of at least 0.015 inch. Normally open contacts shall have a break of at least 0.025 inch.

**PLUNGERS**

**3.06** Plungers should move freely throughout entire travel without binding or squeaking. They are accessible from the underside of the housing when the handhold cover is removed.

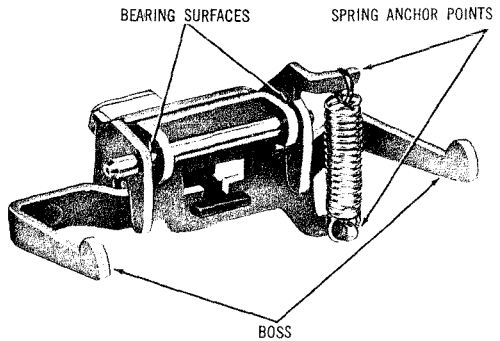
**LINE SWITCH ASSEMBLY**



*Do not perform any field maintenance other than replacing cover, cleaning contacts, and lubricating bearing points.*

**3.07** Remove switch cover by depressing sides between thumb and index finger and tilting cover away from mounting.

- 3.08** Clean contacts with a 265C tool.
- 3.09** The operating bracket assembly should function without binding or squeaking.
- 3.10** To eliminate any binding or squeaking, clean bosses on operating bracket arms, spring anchor points, operating brackets, shaft bearing points, and pins with a KS-2423 cloth moistened with KS-7860 petroleum spirits. Lubricate bearing surfaces (Fig. 2) with a No. 2 or softer graphite pencil.



**Fig. 2 — Line Switch Assembly**

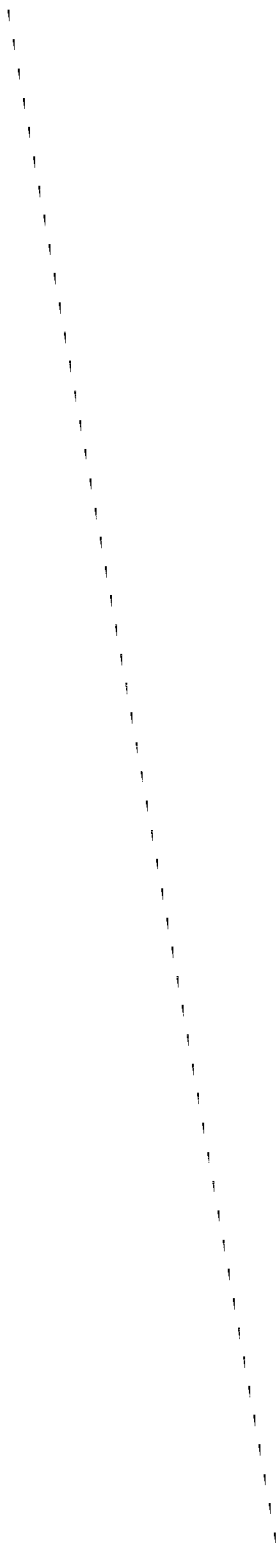
**DIAL**

**3.11** If no tones are heard when a dial button is depressed, check line polarity.



*Do not attempt repair of TOUCH-TONE® dials in the field. Replace dial.*

**3.12** When replacing a 35B3 dial with a 35Q3B dial connect the O-BK, V-W, V-G, R, RG and W leads to the same locations and move the S-G Key lead from LI to RR on the network.



TELEPHONE SETS  
502, 510, AND 511 TYPES  
COMMON BATTERY — CONNECTIONS

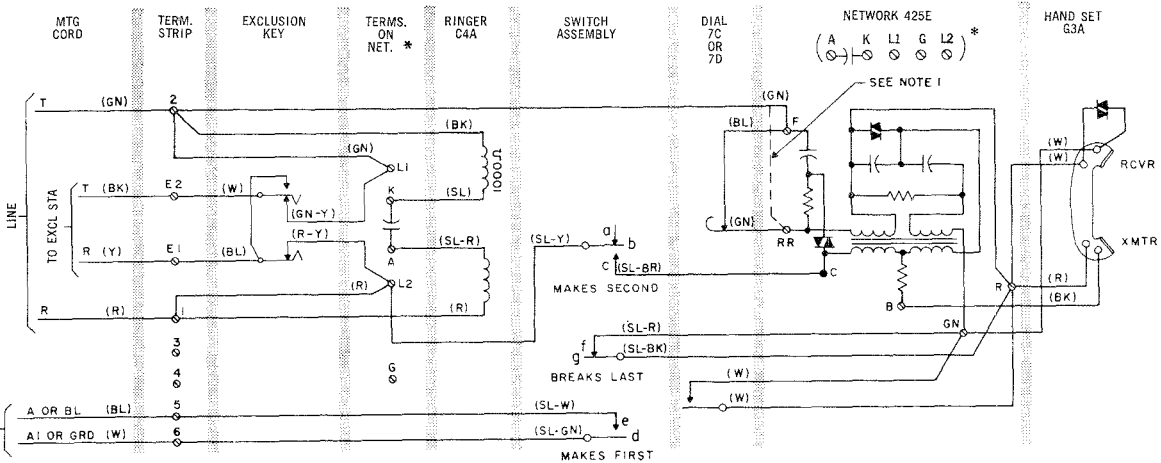


TABLE A  
502B LINE AND RINGER CONNECTIONS

Features		Connections to Terminals Inside Set												External Connections for Mounting Cord										
Number of Lines Picked Up	Ringer in Set Used As	Exclusion Key Used to Cut Off	Mounting Cord Leads			Exclusion Key Leads			Ringer Leads (Notes 3 and 4)			Line		Exclusion Circuit		Com or Pvt Line Ringer Circuit		Key Equip. or Sta Busy Lamp Circuit						
			R	GN	Y	BK	BL	W	R-Y	GN-Y	BL	W	R	BK	SL	SL-R	Ring	Tip	Ring	Tip	R	B	A or BL	A1 or GRD
1	•	•	1	2	E1	E2	5	6	L2	L1	E1	E2	1	2	K	A	R	GN	Y	BK			BL	W
1	•	•	1	2	E1	E2	5	6	4	3	E2	3	E1	4	A	A	R	GN			Y	BK	BL	W

Note 1: GN lead is connected to F terminal in dial sets and to RR terminal in manual sets.

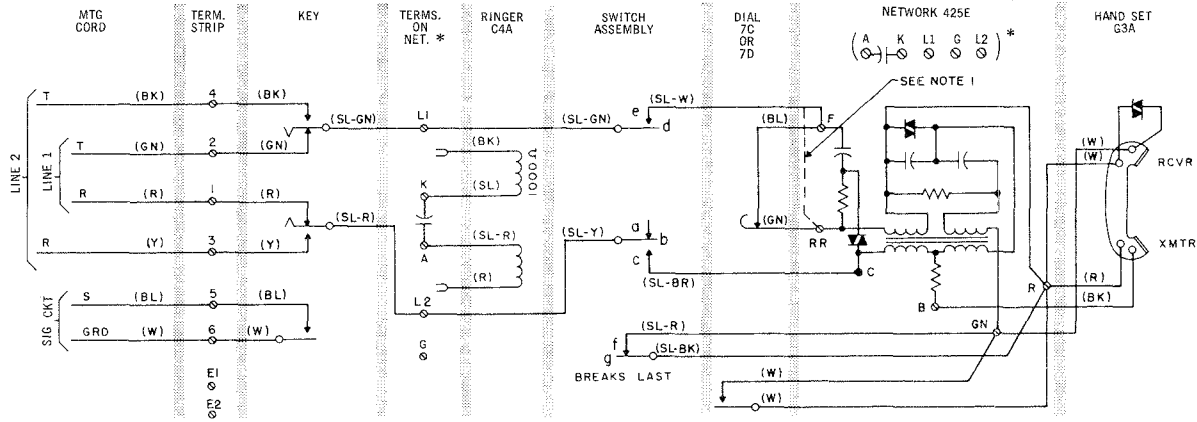
Note 2: When A and A1 control leads are used with station busy lamp circuit, use 511D telephone set.

Note 3: A 7 or QBX1A buzzer may be substituted for the ringer as a common or private line audible signal. A 44B bracket is required with a 7-type buzzer.

Note 4: To silence ringer permanently, connect BK ringer lead to terminal K on network.

FIG. 1 — 502B TELEPHONE SET  
(Exclusion and Control Leads)

OR KEY EQUIP LAMP CKT  
OR STA BUSY LAMP CKT  
(SEE NOTE 2)



**Note 1:** SL-W switch lead is connected to F terminal in dial sets and to RR terminal in manual sets.

**Note 2:** Two-line pickup connections in Tables B and C provide for ringing on line 1. For ringing on line 2, connect R and BK ringer leads to terminals 3 and 4, respectively.

**Note 3:** A 7 or QBX1A buzzer may be substituted for the ringer as a common or private line audible signal. A 44B bracket is required with a 7-type buzzer.

**Note 4:** To silence ringer permanently, connect BK ringer lead to terminal K on network.

**FIG. 2 — 510B, F TELEPHONE SET  
(Two-line Pickup and Signalling)**

**TABLE B**  
**510 B LINE AND RINGER CONNECTIONS**  
 (EQUIPPED WITH 4-CONDUCTOR MOUNTING CORD)

Features (Ringer in Set Used as Line Ringer)					Corrections for Terminals Inside Set										External Connections for Mounting Cord							
Number of Lines Picked Up	Signaling	Turn Key Used to Cut Off			Mounting Cord Leads				Turn Key Leads		Ringer Leads (Notes 2 and 4)				Line 1		Line 2		Signal Circuit		Cutoff Circuit	
		Ext Sta or Ext Line Ringer	Ringer in SW	Auxiliary Receiver	2	GN	Y	BK	SL-R	SL-GN	R	BK	SL	SL-R	Ring	Tip	Ring	Tip	S	GRD	Ring	Tip
1	•				L2	L1	5	6	L2	L1	L2	L1	K	A	R	GN			Y	BK		
1	•		•		L2	L1	5	6	L2	L1	1	2	K	A	R	GN			Y	BK		
1		•			L2	L1	3	4	L2	L1	L2	L1	K	A	R	GN					Y	BK
1		•	•		L2	L1	3	4	L2	L1	1	2	K	A	R	GN					Y	BK
1				•	L2	L1	3	4	GN	R	L2	L1	K	A	R	GN					Y	BK
2					1	2	3	4	L2	L1	1	2	K	A	R	GN	Y	BK				

**TABLE C**  
**510F LINE AND RINGER CONNECTIONS**  
 (EQUIPPED WITH 6-CONDUCTOR MOUNTING CORD)

Features						Connections to Terminals Inside Set										External Connections for Mounting Cord																	
Number of Lines Picked Up	Signaling	Ringer in Set Used as		Turn Key Used to Cut Off		Mounting Cord Leads						Turn Key Leads				Ringer Leads (Notes 2, 3, and 4)				Line 1		Line 2		Signal Circuit		Cutoff Circuit		Com or Pvt Line Ringer Circuit					
		Line Ringer	Com or Pvt Line Ringer	Ext Sta or Ext Line Ringer	Ringer in Set	Auxiliary Receiver	R	GN	Y	BK	BL	W	SL-R	SL-GN	R	BK	SL	SL-R	Ring	Tip	Ring	Tip	S	GRD	Ring	Tip	R	B					
1	•	•		•								L2	L1	3	4	5	6	L2	L1	L2	L1	K	A	R	GN			BL	W	Y	BK		
1	•	•		•	•							L2	L1	3	4	5	6	L2	L1	1	2	K	A	R	GN			BL	W	Y	BK		
1	•	•				•						L2	L1	3	4	5	6	GN	R	L2	L1	K	A	R	GN			BL	W	Y	BK		
2	•	•										1	2	3	4	5	6	L2	L1	1	2	K	A	R	GN	Y	BK	BL	W				
2		•										1	2	3	4	E1	E2	L2	L1	E1	E2	A	A	R	GN	Y	BK					BL	W

510B, F TELEPHONE SET (Cont)



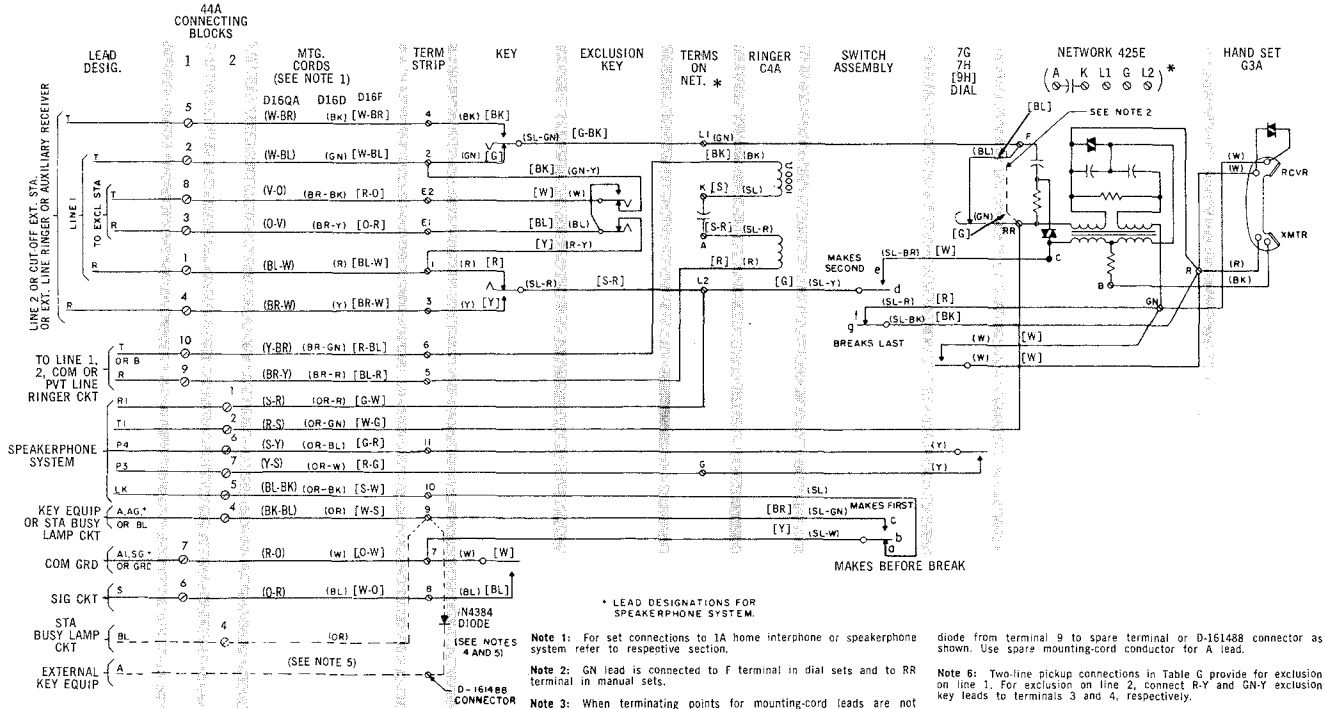


FIG. 3 — 511D TELEPHONE SET  
(Two-line Pickup, Signaling, Exclusion, and Control Leads)

TABLE D  
SPEAKERPHONE CONNECTIONS

Load Desig.	R1	T1	F6	E6	LK	A0	A1 or SG
Mtg. Cord D16D	OR-R	OR-GN	OR-W	OR-BL	OR-BK	OR	W
Mtg. Cord (D16QA)	S-R	R-S	Y-S	S-Y	EL-BK	BK-EL	R-O

TABLE E  
511D LINE AND RINGER CONNECTIONS  
(INTERNAL CONNECTIONS)

Features (Signaling Included With All Features)										Connections to Terminals Inside Set																												
Number of Lines Picked Up	Ringer in Set Used as		Turn Key Used to Cut Off			Exclusion Key Used to Cut Off			Mounting Cord Leads														Turn Key Leads	Exclusion Key Leads (Note 6)			Ringer Leads (Note 7)											
	Line Ringer	Ringer in Set	Conn. of Pkt Line Ringer	Ext Sta or Ext Line Ringer	Ringer in Set	Auxiliary Receiver	Ext Sta or Ext Line Ringer	Ringer in Set	D16QA Cord																													
									BL-W	W-BL	BR-W	W-BR	O-R	R-O	BR-Y	Y-BR	O-V	V-O	S-R	R-S	BL-BK	S-Y								Y-S	BK-BL							
	D16D Cord														R	GN	Y	BK	BL	W	BR-R	BR-GN								BR-Y	BR-BK	OR-R	OR-GN	OR-BK	OR-BL	OR-W	OR	SL-R
1	•			•			•		L2	L1	3	4	8	7	5	6	E1	E2	L2	RR	10	11	G	9	L2	L1	L2	L1	E1	E2	5	6	K	A				
1	•		•				•		L2	L1	3	4	8	7	5	6	E1	E2	L2	RR	10	11	G	9	L2	L1	L2	L1	E1	E2	1	2	K	A				
1	•			•			•		L2	L1	3	4	8	7	5	6	E1	E2	L2	RR	10	11	G	9	L2	L1	L2	L1	E1	E2	3	4	K	A				
1	•				•		•		L2	L1	3	4	8	7	5	6	E1	E2	L2	RR	10	11	G	9	GN	R	L2	L1	E1	E2	5	6	K	A				
2	•						•		1	2	3	4	8	7	5	6	E1	E2	L2	RR	10	11	G	9	L2	L1	1	2	E1	E2	5	6	K	A				
2		•					•		1	2	3	4	8	7	5	6	E1	E2	L2	RR	10	11	G	9	L2	L1	1	2	E1	E2	5	6	A	A				
2			•				•		1	2	3	4	8	7	5	6	E1	E2	L2	RR	10	11	G	9	L2	L1	5	6	E1	E2	E1	E2	A	A				

**TABLE F**  
**511D LINE AND RINGER CONNECTIONS**  
**(EXTERNAL CONNECTIONS)**

44A Connecting Blocks Terminations	External Connections for Mounting Cord (Notes 1 and 3)																
	D16QA Cord																
	BL-W	W-BL	BR-W	W-BR	O-R	R-O	BR-Y	Y-BR	O-V	V-O	S-R	R-S	BL-BK	S-Y	Y-S	BK-BL	
	D16D Cord																
	R	GN	Y	BK	BL	W	BR-R	BR-GN	BR-Y	BR-BK	O-R	O-GN	O-BK	O-BL	O-W	O	
	Line 1		Line 2 or Cut-off Circuit		Signal Circuit		Ringer Circuit * *		Exclusion Circuit		Speakerphone					"A" Lead or B.L. *	
Ring	Tip	Ring	Tip	S	A1 or SG	R	T or B	Ring	Tip	RI	TI	LK	P4	P3	A or BL		
BLOCK #1	1	2	4	5	6	7	9	10	3	8							
BLOCK #2												1	2	5	6	7	4

\* See Notes 4 & 5  
 \*\* See Note 8

**511D TELEPHONE SET**

TELEPHONE SETS  
558, B, AND D TYPES  
COMMON BATTERY — CONNECTIONS

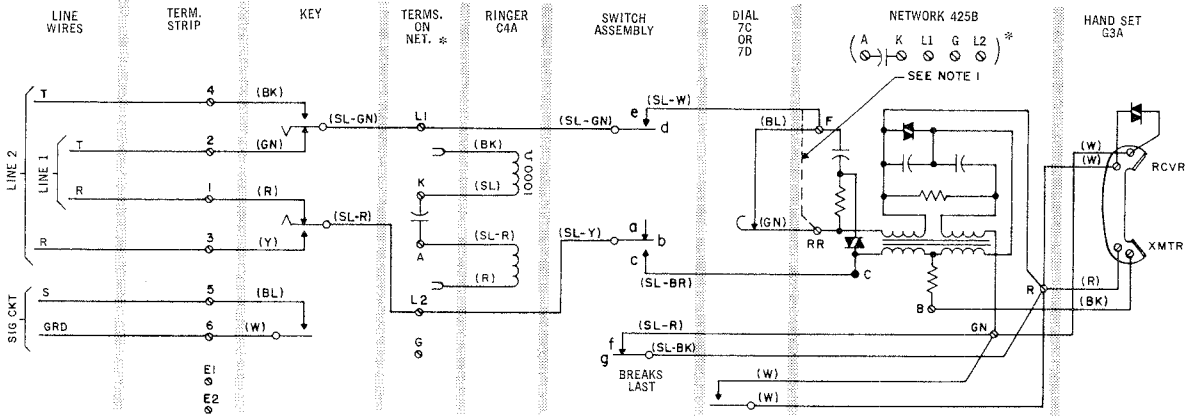


TABLE A  
558B LINE AND RINGER CONNECTIONS

Features (Signaling Included With All Features)							Connections to Terminals Inside Set					Connections for Inside Wire in Set										
Number of Lines Picked Up	Ringer in Set Used as		Turn Key Used to Cut Off				Turn Key Leads					Line 1		Line 2		Signal Circuit		Cutoff Circuit		Common or Private Line Ringer Circuit		
	Line Ringer	Com or Pvt Line Ringer	Ext Sta or Line Ringer	Ext Com or Pvt Line Ringer	Com or Pvt Line Ringer in Set	Auxiliary Receiver	SL-R	SL-GN	R	BK	SL	SL-R	Ring	Tip	Ring	Tip	S	GRD	Ring or R	Tip or B	R	B
1	•		•				L2	L1	L2	L1	K	A	L2	L1			5	6	3	4		
1	•				•		L2	L1	3	4	K	A	L2	L1			5	6				
1	•		•		•		L2	L1	1	2	K	A	L2	L1			5	6	3	4		
1		•	•				L2	L1	E1	E2	A	A	L2	L1			5	6	3	4	E1	E2
1		•			•		E1	E2	3	4	A	A	L2	L1			5	6			E1	E2
1	•			•		•	GN	R	L2	L1	K	A	L2	L1			5	6	3	4		
2	•						L2	L1	1	2	K	A	1	2	3	4	5	6				
2	•						L2	L1	E1	E2	A	A	1	2	3	4	5	6			E1	E2

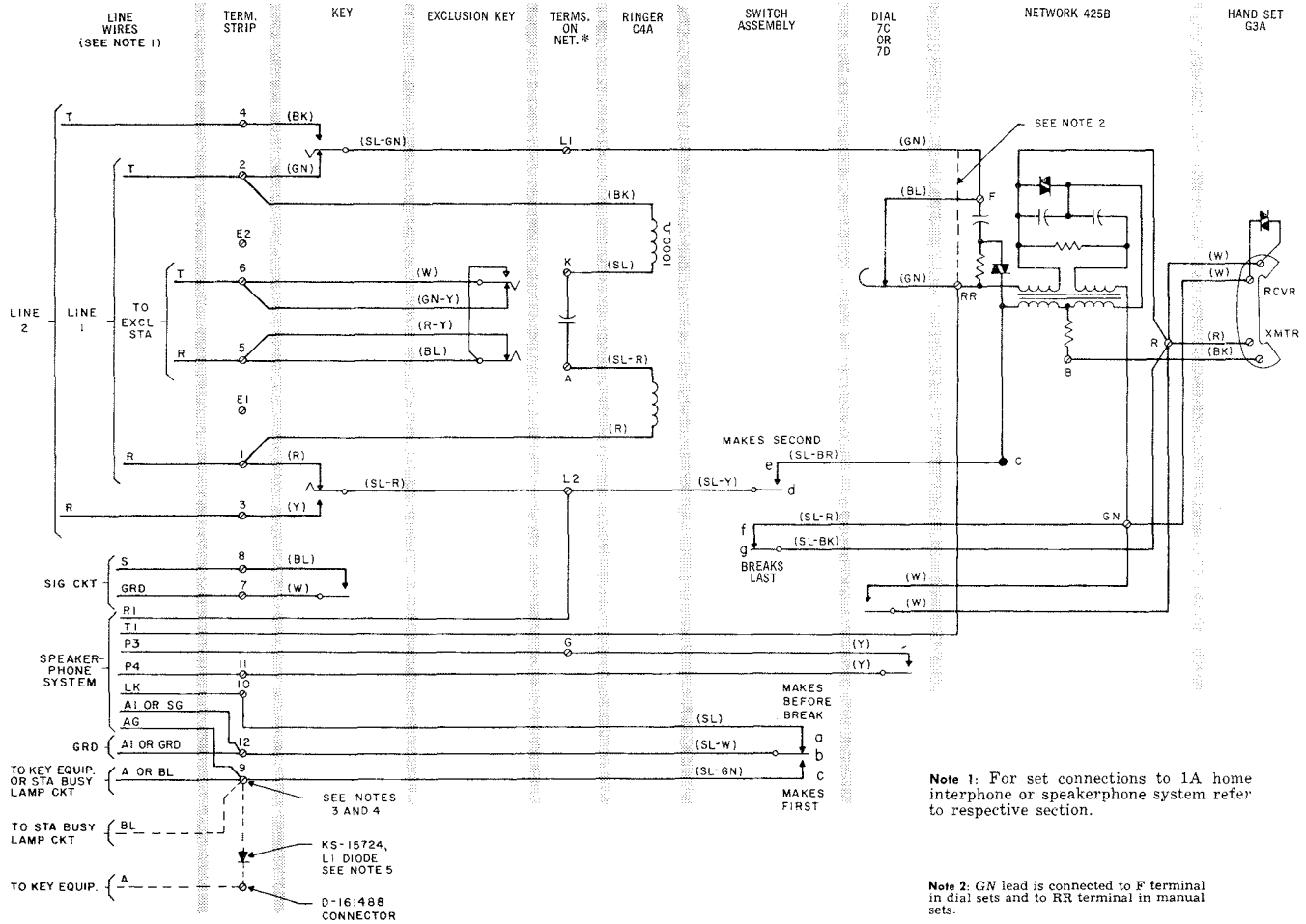
Note 1: SL-W switch lead is connected to F terminal in dial sets and to RR terminal in manual sets.

Note 2: Two-line pickup connections in Table A provide for ringing on line 1. For ringing on line 2, connect R and BK ringer leads to terminals 3 and 4, respectively.

Note 3: A 7-type buzzer on a 44B bracket may be substituted for the ringer as a common or private line audible signal.

Note 4: To silence ringer permanently connect BK ringer lead to terminal K on network.

FIG. 1 — 558B TELEPHONE SET  
(Two-line Pickup and Signaling)



**FIG. 2 — 558D TELEPHONE SET**  
**(Two-line Pickup, Signaling, Exclusion, and Control Leads)**

TABLE B  
SPEAKERPHONE CONNECTIONS

Lead Desig	R1	T1	P3	P4	LK	AG	A1 or SG
Terms in Set	L2	RR	G	11	10	9	12

Note 3: Use A and A1 control leads on 1-line pickup features only.

Note 4: SL-W switch lead is factory-wired to terminal 9. Transfer this lead from terminal 9 to terminal 12, as required.

TABLE C  
558D LINE AND RINGER CONNECTIONS  
(INTERNAL CONNECTIONS)

Features (Signaling Included With All Features)										Connections to Terminals Inside Set									
Number of Lines Picked Up	Ringer in Set Used as		Turn Key Used to Cut Off				Exclusion Key Used to Cut Off		Turn Key Leads		Exclusion Key Leads (Note 6)				Ringer Leads (Notes 7, 8, and 9)				
	Line Ringer	Com or Ext Line Ringer	Ext Sta or Line Ringer	External Com or Ext Line Ringer	Ringer in Set	Auxiliary Receiver	Ext Sta or Ext Line Ringer	Ringer in Set											SL-R
1	•		•				•		L2	L1	L2	L1	5	6	L2	L1	K	A	
1	•				•		•		L2	L1	L2	L1	5	6	3	4	K	A	
1	•		•		•		•		L2	L1	L2	L1	5	6	1	2	K	A	
1		•	•				•		L2	L1	L2	L1	5	6	E1	E2	A	A	
1		•			•		•		E1	E2	L2	L1	5	6	3	4	A	A	
1		•		•	•		•		E1	E2	L2	L1	5	6	1	2	A	A	
1	•					•	•		GN	R	L2	L1	5	6	L2	L1	K	A	
2	•						•		L2	L1	1	2	5	6	1	2	K	A	
2		•					•		L2	L1	1	2	5	6	E1	E2	A	A	
2		•						•	L2	L1	E1	E2	5	6	5	6	A	A	

Note 5: Use dotted-line connections when A and A1 control leads and station busy lamp circuit are used together. Install KS-15724, List 1 diode from terminal 9 to spare terminal or D-161488 connector as shown.

Note 6: Two-line pickup connections in Table C provide for exclusion on line 1. For exclusion on line 2, connect R-Y and GN-Y exclusion key leads to terminal 3 and 4, respectively.

Note 7: Two-line pickup connections in Table C provide for ringing on line 1. For ringing on line 2 connect R and BK ringer leads to terminals 3 and 4, respectively.

Note 8: A 7-type buzzer on a 44B bracket may be substituted for the ringer as a common or private line audible signal.

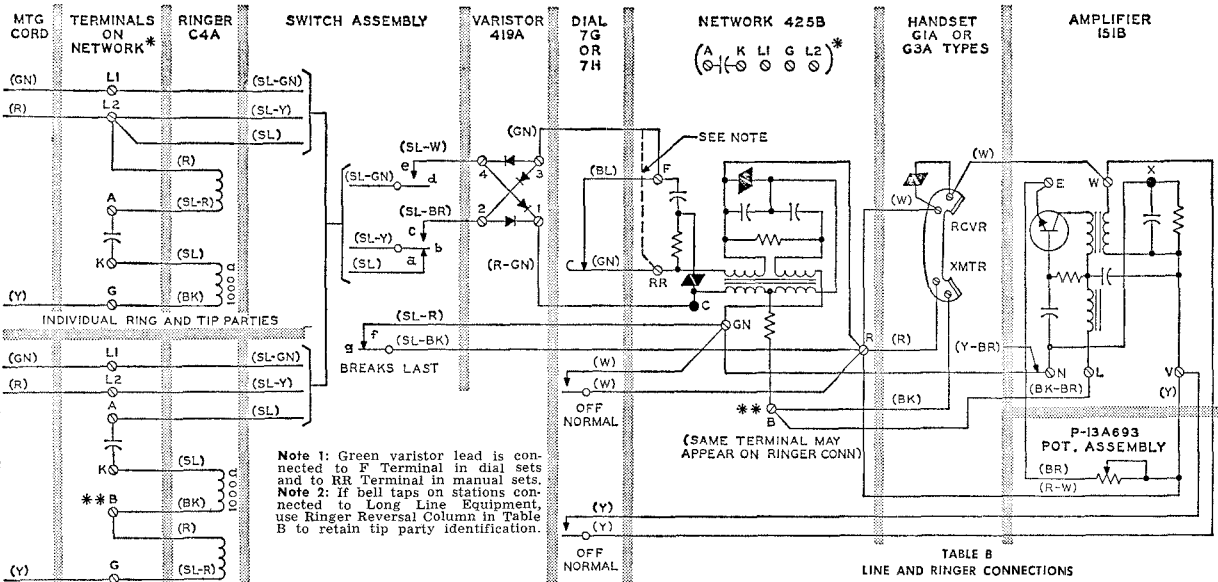
Note 9: To silence ringer permanently, connect BK ringer lead to terminal K on network.

TABLE D  
558D LINE AND RINGER CONNECTIONS  
(INSIDE WIRE CONNECTIONS)

Number of Lines Picked Up		Features (Signaling Included With All Features)								Connections to Inside Wire in Set													
		Ringer in Set Used as		Turn Key Used to Cut Off			Exclusion Key Used to Cut Off			Line 1		Line 2		Signal Circuit		Exclusion Circuit		Cutoff Circuit		Com or Pvt Line Ringer Circuit		Key Equip. or Sta Busy Lamp Ckt (Notes 3, 4, and 5)	
		Line Ringer	Com or Pvt Line Ringer	Ext Sta or Ext Line Ringer	External Pvt Line Ringer	Ringer in Set	Auxiliary Receiver	Ext Sta or Ext Line Ringer	Ringer in Set	Ring	Tip	Ring	Tip	S	GRD	Ring	Tip	Ring or R	Tip or B	R	B	A or BL	A1 or GRD
1	•		•				•		L2	L1			8	7	5	6	3	4			9	12	
1	•						•		L2	L1			8	7	5	6					9	12	
1	•		•				•		L2	L1			8	7	5	6	3	4			9	12	
1		•	•					•	L2	L1			8	7	5	6			E1	E2	9	12	
1		•					•		L2	L1			8	7	5	6			E1	E2	9	12	
1		•		•			•		L2	L1			8	7	5	6	3	4	E1	E2	9	12	
1	•					•		•	L2	L1			8	7	5	6	3	4			9	12	
2	•							•	1	2	3	4	8	7	5	6					9	12	
2		•						•	1	2	3	4	8	7	5	6			E1	E2	9	12	
2		•						•	1	2	3	4	8	7					E1	E2	9	12	

558D TELEPHONE SET (Cont'd)

TELEPHONE SETS — 532B,  
(AMPLIFIER SETS FOR IMPAIRED HEARING) — COMMON BATTERY — CONNECTIONS



Note 1: Green varistor lead is connected to F Terminal in dial sets and to RR Terminal in manual sets.  
Note 2: If bell taps on stations connected to Long Line Equipment, use Ringer Reversal Column in Table B to retain tip party identification.

TABLE A  
RINGER LEAD CONNECTIONS  
TO SILENCE RINGER PERMANENTLY

Class of Ringing Service	Ringer Leads			
	Red	Black	Slate	Sl-Red
Tip Pky with 2650 Ω Idfy Grd	B	K	K	G
Bridged when used with 1A1 Key Tel System	L2	L2	K	A

For all classes of service except those listed above:  
Connect yellow mounting cord lead to same terminal as red mounting cord lead at connecting block.

532B TELEPHONE SET

TABLE B  
LINE AND RINGER CONNECTIONS

Wire or Lead	Individual or Bridged †	1A1 Key Tel Sys ‡						Tip Party Identification 2650Ω			
		Party	No Ident. Grd.	Normal Connection	Ringer Reverse (Note 2)						
Mounting Cord in Set	R	L2	L2	L2	L2	L2	L2	L2			
	GN	L1	4	L1	L1	L1	L1	L1			
	Y	G	G	G	G	G	G	G			
	BK	L1									
Ringer Leads	R	L2	L2	L2	L2		B	G			
	BK	G	4	G	G		B	K			
	SL	K	K	K	K		K	B			
Switchhook Leads	SL-R	A	A	A	A		A	B			
	SL	L2	L2	L2	L2		A	A			
	SL-W	4	G	4	4		4	4			
Mounting Cord at Connecting Block	R	R	R	R	G		G	G			
	GN	G	G	G	R		R	R			
	Y	G	Y	Y	Y		Y	Y			
Line Wire at Connecting Block	BK	B	B	B							
	R	R	R	R	R		R	R			
	GN	G	G	G	G		G	G			
	Y	Y	Y	Y	Y		Y	Y			
	A	BK		B							

† Not recommended for use with 1A key telephone system on long loops.  
‡ Place 4-conductor mounting cord.



When telephone set is used with 1A1 key telephone system, switch contact **ed** must break last when handset is restored.





## TELEPHONE SETS

### 701, 702, AND 711 TYPES

#### IDENTIFICATION, INSTALLATION, AND MAINTENANCE

#### 1. GENERAL

1.01 This section covers PRINCESS® telephone sets equipped with rotary dials (Fig. 1).

1.02 Information contained in this section was formerly found in Section 502-710-100, 502-710-200, and 502-710-300 which have been cancelled.

#### 2. IDENTIFICATION

2.01 These sets are equipped with a concealed lamp which illuminates the dial when the handset is removed. This lamp also serves as a

night light under control of a slide switch located in the base at rear of set (Fig. 2).

2.02 The transmission circuit for the 700-type telephone set is the same as for the 500-type telephone set. However, since the ringer is always external with a 701 and 711-type telephone set, there is no ringing capacitor in the network. The 702 type however, incorporates the capacitor and an M1A ringer.

2.03 Table A lists the major components of 700-series PRINCESS telephone sets.

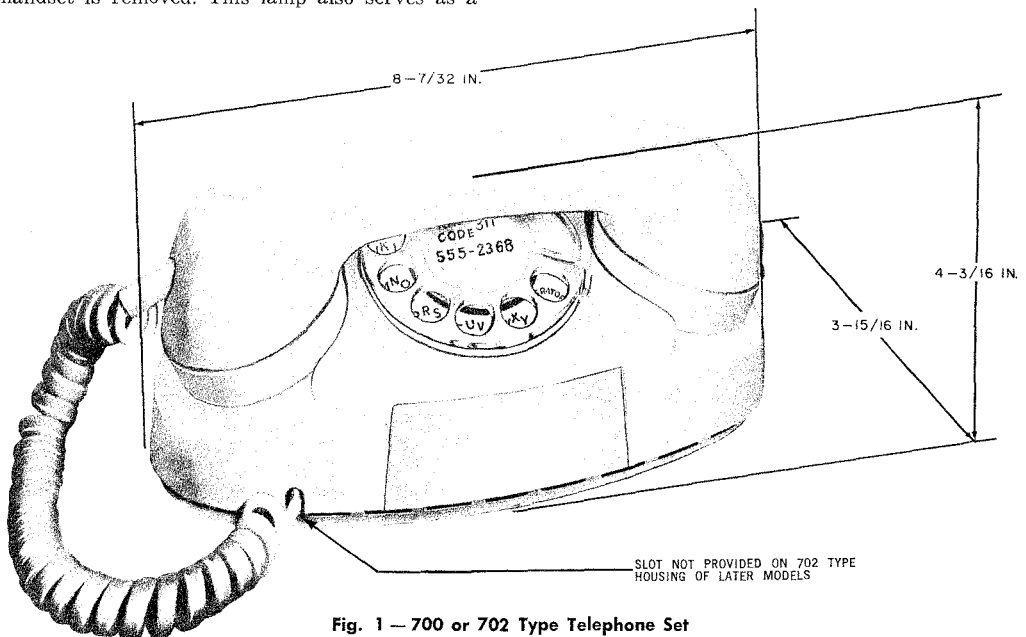


Fig. 1 — 700 or 702 Type Telephone Set

**SECTION 502-710-101CA**

**TABLE A**  
**COMPONENTS AND FEATURES — 700-SERIES PRINCESS STYLE TELEPHONE SET**

TYPE SET	MOUNTING CORD	NETWORK	INTERNAL RINGING	MESSAGE WAITING LAMP*	USED WITH 1A KTS	USED WITH 1A1, 1A2 KTS
701B	D6AB	495A	No	No	Yes	Yes
701D	D6AB	495A	No	KS-16893L1	Yes	No
702BQ1A (a)	D5Q2A	QNB4A-2	Yes	No	Yes	Yes
702BQ1A (b)	D5Q2A	QNB17A	Yes	No	Yes	Yes
711B	D14H	495A	No	No	No	No

\*Lamp Socket - KS16894 List 1.

(a) Manufactured before Jan. 1, 1970.

(b) Manufactured after Jan. 1, 1970.

(c) When equipped with 1635A Inductor.

**TABLE A (Cont)**  
**COMPONENTS AND FEATURES — 700-SERIES PRINCESS STYLE TELEPHONE SET**

TYPE SET	3-TYPE SPEAKER PHONE	1A HOME INTERPHONE	BUSINESS INTERPHONE	EQUIPPED WITH EXCLUSION SWITCH	TIP PARTY IDENT.
701B	No	No	No	No	Yes (c)
701D	No	No	No	No	No
702BQ1A (a)	Yes	No	No	No	No
702BQ1A (b)	Yes	No	No	No	Yes
711B	Yes	Yes	Yes	Yes	

**Note:** The following components are common to all 700-series PRINCESS telephone sets:

- Dial 8A
- Dial lamp, Mazda GE46
- Dial lamp, socket, P96W200 for 702BQ1A and P11E410 for other 701 and 702 types
- Handset, G3AR
- Handset cord, H4CJ

**2.04** The 700-type telephone sets are available in the following colours:

- |                 |                   |
|-----------------|-------------------|
| White (-58)     | Aqua blue (-62)   |
| Rose pink (-59) | Turquoise (-64)   |
|                 | Light beige (-60) |

**701-Type Telephone Set**

**2.05** The 701-type telephone sets are rated Manufacture Discontinued (MD).

**2.06** The 701B and 701D telephone sets are not equipped with an internal ringer. When a ringer is required, an E1-type external ringer may be used.

**2.07** The 701B sets are factory wired for individual line or 2-party flat rate service. Internal wiring changes must be made when other services are to be provided. See sections covering telephone set connections.

**2.08** 701B telephone sets may be used with the following services:

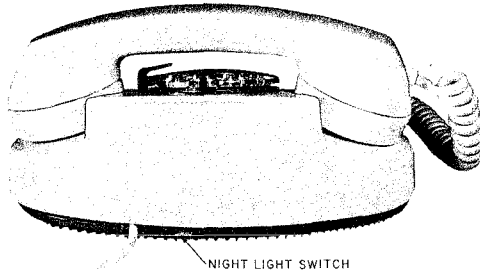


Fig. 2 — 700-Series Telephone Set, Rear View

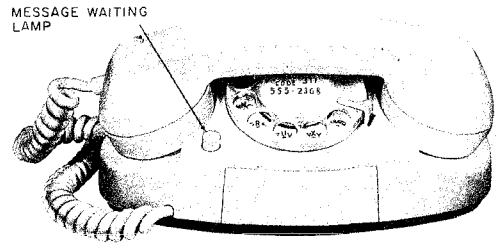


Fig. 3 — 701D-Type Telephone Set

- Tip-Party Identification.

If no ringer is in place, the 1635A inductor must be used for identification. (See Fig. 13 and 14).

- 1A1 and 1A2 key telephone systems
- 3-type speakerphone system

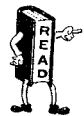
**2.09** The 701D telephone set is equipped with a message waiting lamp (see Fig. 3 & 4). This set is intended for use with PBX which provides message waiting feature.

#### 702 Type Telephone Set

**2.10** The 702 type telephone set Fig. 5. is similar to the 701 type except that an internal ringer (MIA) is provided in the base of the set.

**2.11** The 702B type telephone set replaces the 701B type set.

**2.12** The 702B type differs from the 701 and 711 types, in that it uses a printed circuit type network and quick connect terminals. Cord connections are made to the networks by pushing spade tips into split terminals, Figs. 10 and 11. 702B Sets manufactured before Jan. 1, 70 are equipped with the QNB4A-2 network and after that date, the QNB17A network.



**2.13** When inserting or removing spade tips from quick-connect terminals, longnose pliers must be used. For detailed instructions, see Para. 3.02.

**2.14** The QNB17A Network has provision for a modification which provides protection from spurious detection of radio frequency signals which may interfere with telephone conversations in certain locations. The modification is accomplished by adding two NS169921 capacitors in the holes designated C5 and C6 on the printed circuit board.

**2.15** The 702B and 702BQ1A telephone sets with QWB4A-2 Networks are *not* designed for use with:

- 1A1 and 1A2 Key Telephone Systems.
- *Tip Party identification.* The 702BQ1A set equipped with the QNB17A Network facilitates wiring changes within the telephone to allow its use for these services and also with 3 type Speakerphone.

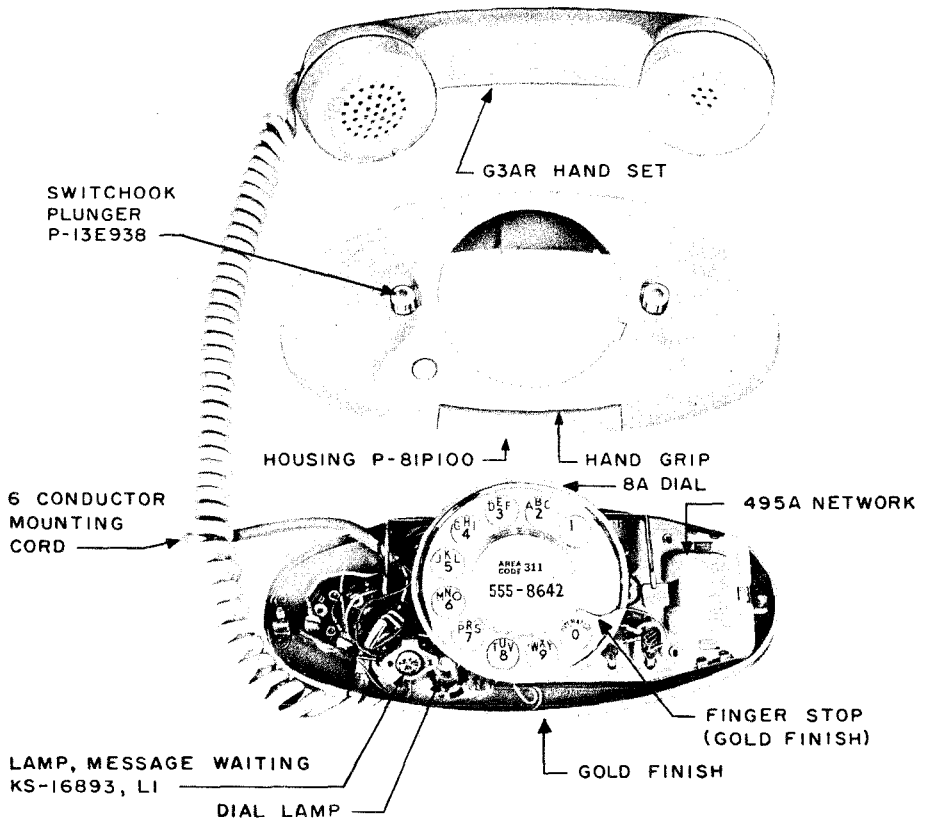


Fig. 4 - 701D Telephone Set with Housing Removed

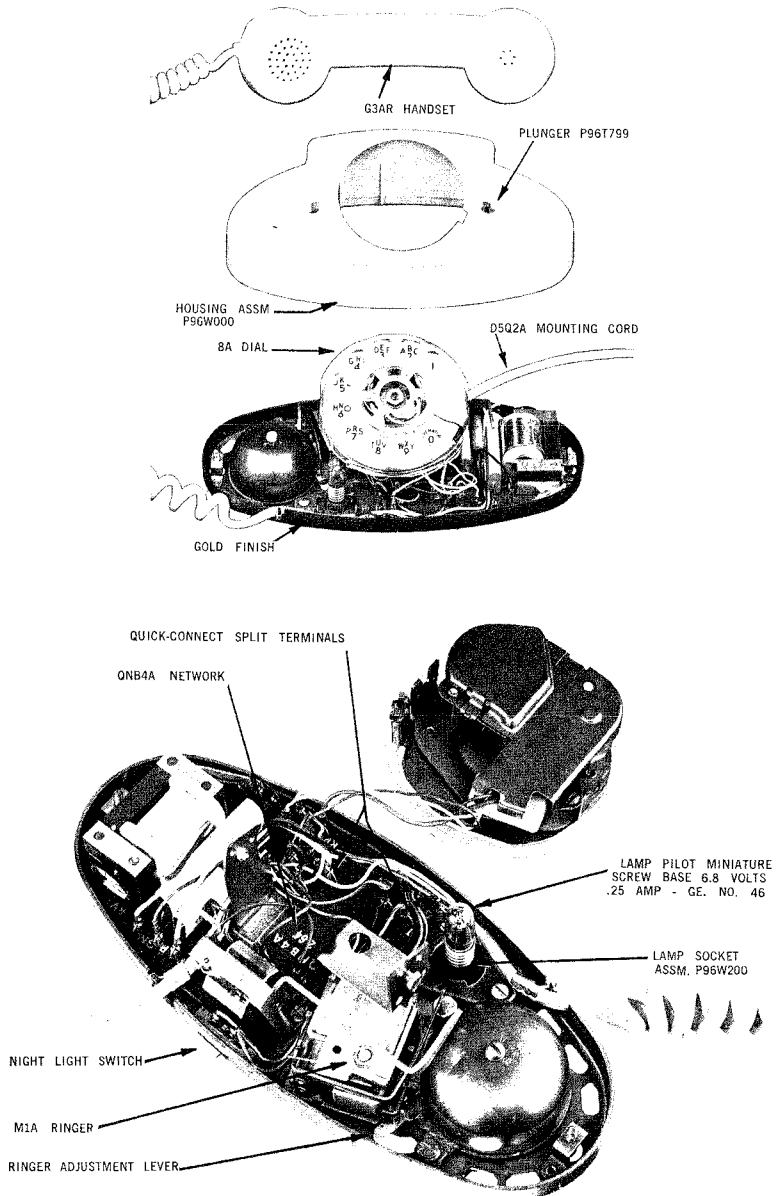


Fig. 5 - 702BQ1A Telephone Set Showing Circuit Board Network

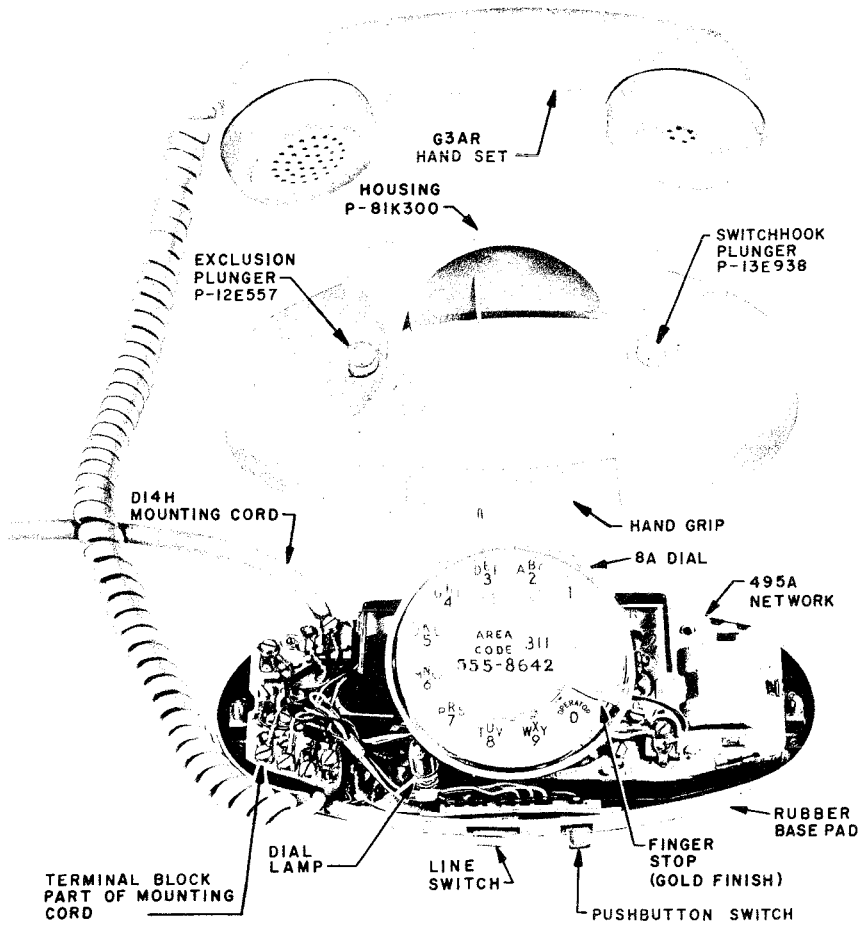


Fig. 6 - 711B Telephone Set with Housing Removed

### 711B Telephone Set

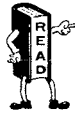
- 2.16 The 711B telephone set (Fig. 6) is not equipped with an internal ringer. When a ringer is required, an E1-type external ringer may be used.
- 2.17 The 711B telephone set is equipped with a slide switch for line selection and a switch (push-to-operate) for signaling.
- 2.18 This set is factory wired for 2-line pickup, exclusion, and signaling. The exclusion feature is operated by raising the left switch hook plunger.
- 2.19 This set may also be used with the following services:
- 1A HOME INTERPHONE system
  - BUSINESS INTERPHONE system (F)
  - 3-type speakerphone system
- 2.20 This set is not equipped for "A" lead control and cannot be used with 1A1 or 1A2 key telephone systems, or for Tip-party Identification.

### 3. INSTALLATION

3.01 Insofar as possible, be guided by the customer's wishes in placing apparatus. Consider the following:

- Safety for yourself, customer, and maintenance personnel.
- Availability of power outlet for transformer.
- Location of telephone set so ringer volume is adequate for area.
- General appearance of installation.

### Quick-Connect Terminals



3.02 When inserting or removing spade tips from quick-connect terminals of the 702 type telephone, long-nose pliers must be used. On the early design of clip, the cross slot type, always grasp the spade tip by the wing. *To remove* the spade tip grasp the wing of the spade with the pliers held vertically. Insert the tip of the C or D type screwdriver under the tip of the longnose pliers and twist screwdriver so as to lever the pliers upward. *To insert* the spade tip, place it loosely in the quick-connect terminal. Then press it firmly into place with one tip of the pliers on each wing of spade tip. (See Fig. 10) On the later design, dual clip type, *to remove* the spade tip, grasp the spade tip by the shank with long-nose pliers. Use the blade of a screwdriver as a fulcrum to lift the end of the pliers and spade tip clear of the clip. (See Fig. 11) *To insert* spade tip, place it easily in place with the long-nose pliers. Care must be taken to dress all set wiring so as to prevent it from interfering with the switch assembly or dial mechanism. (See Fig. 12)

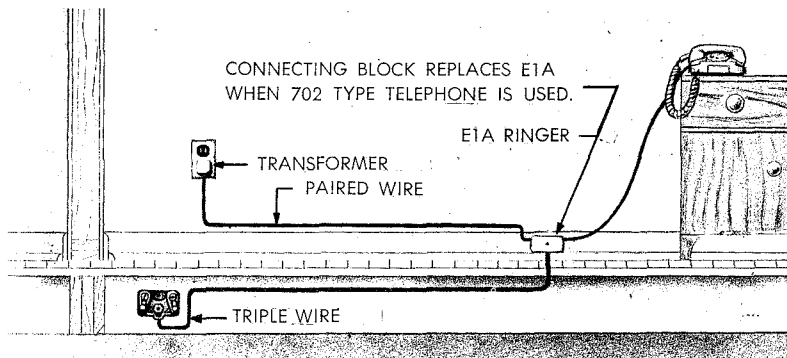


Fig. 7 — Typical Installation of 701B or 702BQ1A Telephone Set



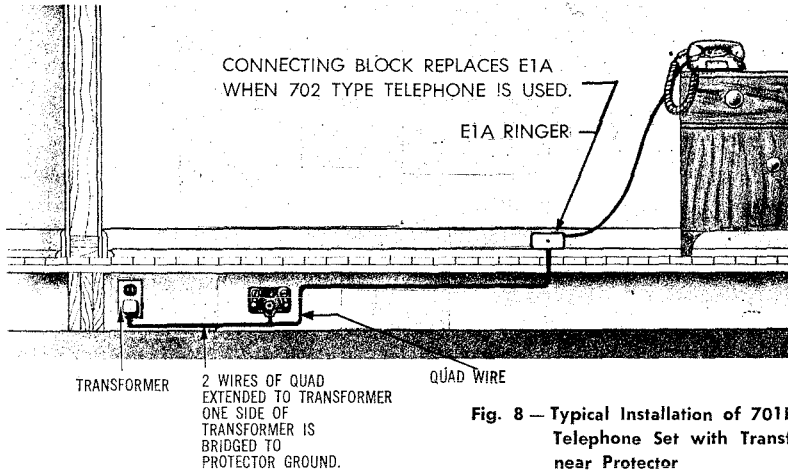


Fig. 8 — Typical Installation of 701B or 702BQ1A Telephone Set with Transformer located near Protector

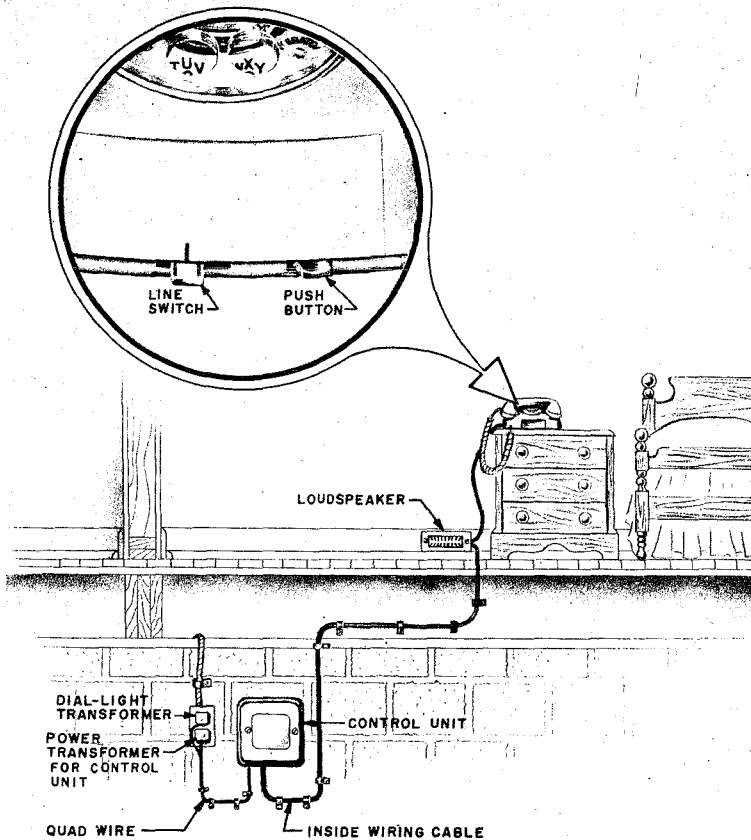


Fig. 9 — Installation of 711B Telephone Set As Used With Home Interphone System

**Dial Light Transformer**

**3.03** Select a 105-120 volt ac receptacle that is on a circuit not controlled by a switch. A 2012A transformer should be used with each telephone set. For multiple installations, see section covering station transformers.

**3.04** For proper illumination of the dial, the length of the wire between the transformer and the telephone set should not exceed 250 feet of standard inside wire. *Do not use a 25-foot mounting cord because of added resistance.*

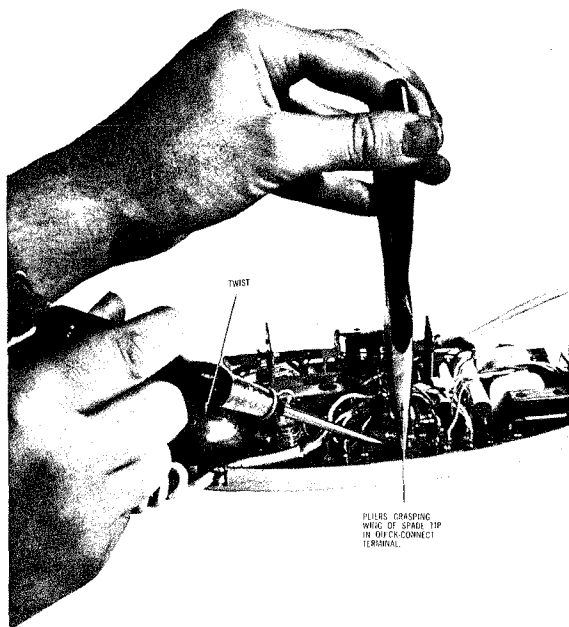
**3.05** When necessary to avoid customer's reaction to the use of receptacle, purchase locally a C.S.A. approved "cube tap" such as the Hale Brothers #1270 and use it for the customer's requirements. Because of insecurity do not plug the 2012A transformer into a cube tap.

**3.06** Where the 2012A transformer may become dislodged from the receptacle, a 2A clamp should be used to secure it.

**3.07** When installing a dial-light transformer, make certain that telephone protector and/or signaling ground conductor is connected to the best ground available as outlined in the section entitled Protector and Signaling Grounds. If the best ground available is a telephone ground rod, the telephone ground rod shall be bonded to the power service ground electrode in the same premises as outlined in the section entitled Protector and Signaling Grounds.

**3.08** Damage to the transformer may result if a sufficient difference of potential is allowed to develop between power and telephone grounds. Because a difference of potential appears between the windings of the transformer, voltage from a lightning surge could break down the insulation between the windings.

**3.09** Grounding the transformer is not necessary unless this ground is required for signaling.



**Fig. 10 — Method for Removing Spade Tips from a 702BQ1A Telephone Equipped With Quick-Connect Terminals**

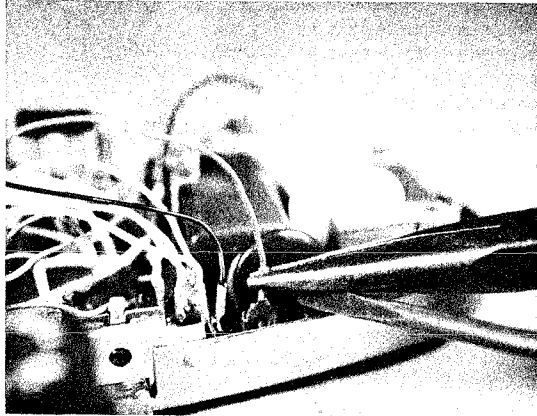


Fig. 11 — Method of removing Spade Tip from a 702BQ1A equipped with latest Quick-Connect Terminals

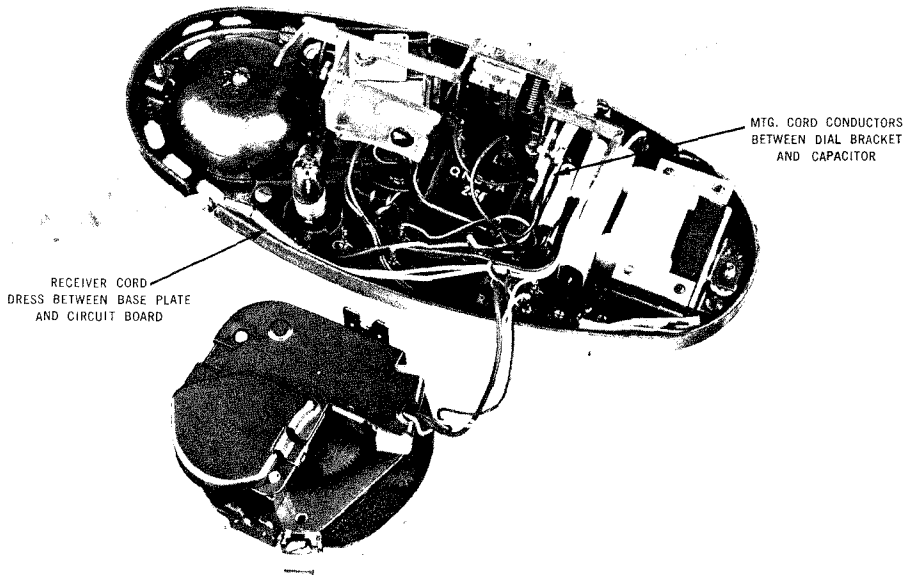


Fig. 12 — Telephone — Location of Set Cording

**Ringer**

**3.10** Where required, an E1A Ringer should be installed with each 701-type telephone. This ringer may also serve as a connecting block. A centrally located QCY1A1 bell chime ringer may also be used. Where the E1A ringer cannot be located for good distribution of sound, a 687A subscriber set may be installed instead. In the case of a 702 type telephone, the M1A ringer is incorporated as part of the telephone and no external ringer is normally required.

**3.11** At the request of the customer, the E1A Ringer normally associated with the 701B telephone may be omitted, or in the case of the 702BQ1A the ringer may be disconnected, except when it is the only ringer on the line. Where no ringer is used, the mounting cord of the 701-type telephone should be terminated on a QBB1A connecting block and the mounting cord of the 711B telephone set, should be terminated on 44A connecting blocks. The 702-type telephone set is normally terminated on a QBB1A connecting block except when wired for 1A1 key operation in which case a 44A block should be used.

**3.12** If a ringer cut-off feature is required, this can be accomplished on the 702-type telephone set by removing the blocking screw from the base of the telephone. This will allow the ringer volume adjusting lever to completely silence the bell. (See appropriate Section on M1A Ringer). This cut-off feature should not be provided unless called for on the service order.

**Inductor**

**3.13** Where no ringer is used with a 701 type telephone and tip-party identification is required, a 1635A inductor shall be installed in the Princess set as shown in Fig. 13 and 14. The inductor is ordered separately. The procedure for installing is as follows:

1. Remove housing from set.
2. Loosen dial and lay aside to provide working space.
3. Insert inductor as shown in Fig. 14.
4. Connect leads for tip party with indentifying ground.
5. Mount dial assuring that the dial mounting lug is between the 1635A inductor bracket and the dial mounting bracket. (See Fig. 14).

**3.14** Tip party identification on the 702BQ1A telephone set is provided by using windings of the M1A ringer. (Refer to section covering connections).

**Electron Tube**

**3.15** When an electron tube is required to combat inductive interference install the tube in the base of the 701B telephone set only in the following manner:

1. Remove plastic housing.
2. Remove dial.
3. Remove and discard the mounting screw furnished as part of the electron tube.
4. Redress terminal 2 end of 27-ohm resistor and resistor lead toward night-light socket.
5. Check to see that lead on terminal end of resistor does not touch dial support bracket.
6. Place the tube in space below dial with dome of tube toward night-light socket and base of plastic tube bracket against dial support bracket (see Fig. 15).
7. If sufficient clearance for the dome of the tube was provided in step 4 above, the lower end of the tube bracket base will drop into place forward of the switch assembly base.
8. Dress tube leads up and across tube between night-light and dial support bracket.
9. Carefully replace the dial, redressing wires as required, so that the glass portion of the tube is *not* held firmly after the dial is secured in place.
10. A D-161488 connector assembly is required and must be ordered separately. Connect the leads from the tube as shown in the section entitled Inductive Noise. (Section 500-112-100CA).
11. Check to see that no wires are fouled in the switch arms, and replace the plastic upper housing.

**Ringer Isolator**

**3.16** When a Ringer Isolator is used to combat inductive interference refer to Section 500-112-100CA for connections.

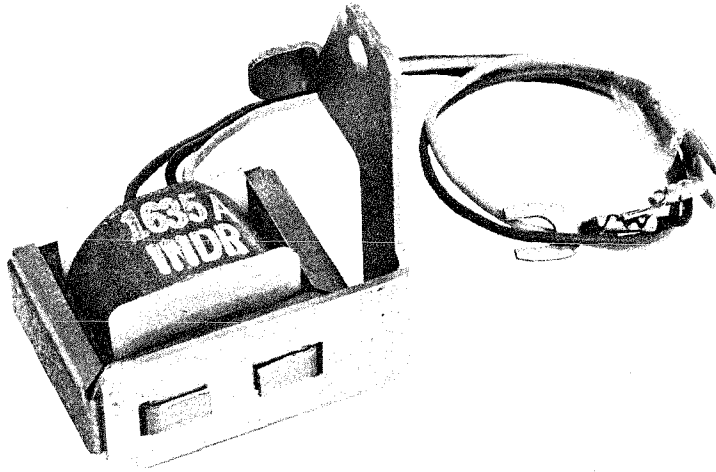


Fig. 13 — 1635A Inductor

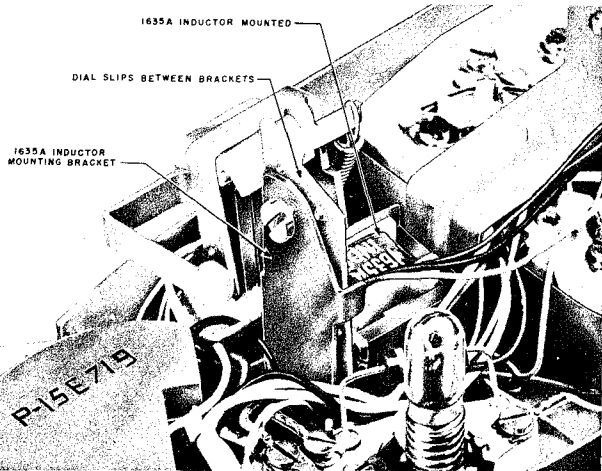


Fig. 14 — 1635A Inductor Mounted in 701B Telephone Set

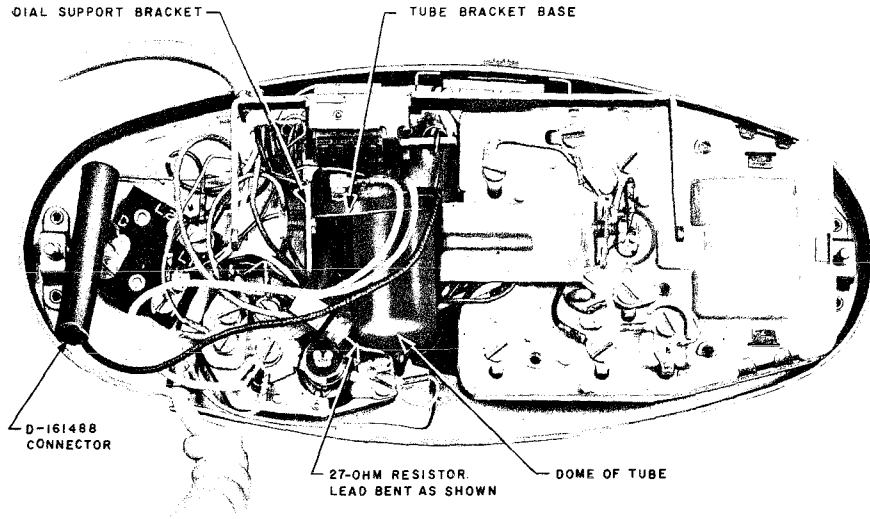


Fig.15 — Location of Cold-Cathode Tube in 701B Telephone Set

#### The P-15E719 Weight

3.17 The P-15E719 weight is designed to reduce sliding of the 701B and 701D telephone sets on smooth surfaces during dialing.



*Make sure that no wires are caught between the weight and base of set.*

3.18 The weight mounts in the telephone set directly over the terminal block (Fig. 16). All leads to the block must be dressed so that the spade tips fall wholly within the boundaries of the block (Fig. 17). The weight shall rest flat on the base of the telephone set. Insert the P-24E510 spring retainer as shown in Fig. 18.

#### PORTABLE INSTALLATION

3.19 For portable installation of the 701-type telephone set, arrange as follows:

- Replace 6-conductor mounting cord with 4-conductor cord terminating in 283B plug.
- Extend tip, ring, ground, and transformer leads to 404B jack.



*On 2-party tip stations requiring ground identification, be sure that jacks and plugs are installed in accordance with the section entitled **Jacks and Plugs**.*

3.20 Where a 702-type telephone is used in a portable installation, the D5Q2A mounting cord need not be changed. Connect to 283B plug in the same manner as shown for QBB1A connecting block.

3.21 The 711B telephone set is not intended for portable installation.

3.22 Where only one dial-light telephone set is installed, one transformer may be multiplied to two or more jacks.

3.23 Where two or more dial-light telephone sets are installed, an individual 2012A transformer must be connected to each jack, or see Section covering station transformers, multiple installations.

Fig. 16 — P-15E719  
Weight Removed  
from 701B  
Telephone  
Set

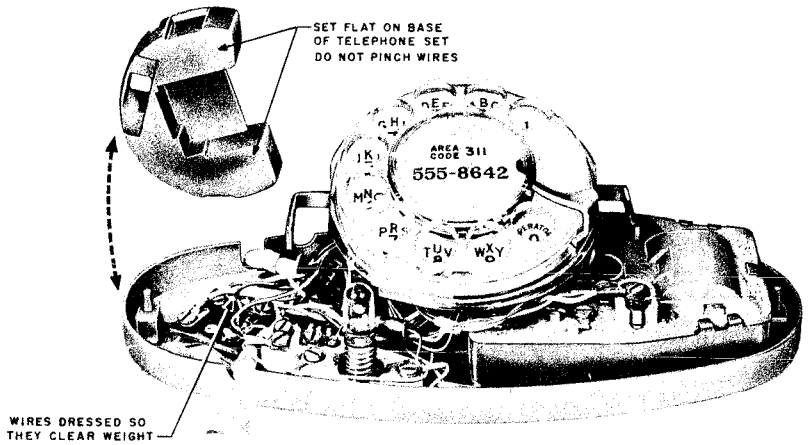


Fig. 17 — P-15E719  
Weight  
Mounted  
in 701B  
Telephone  
Set

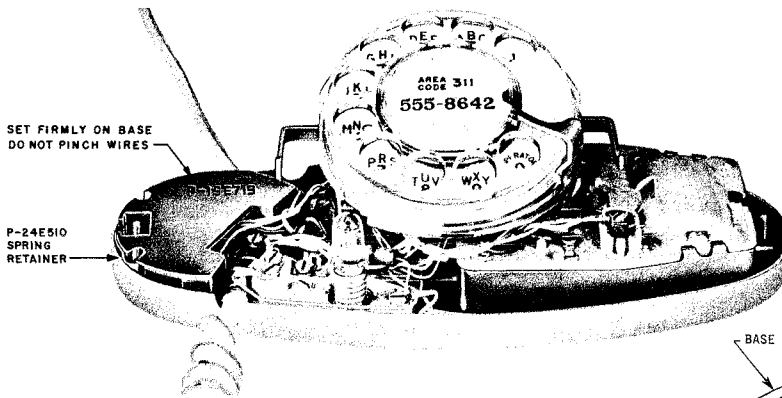
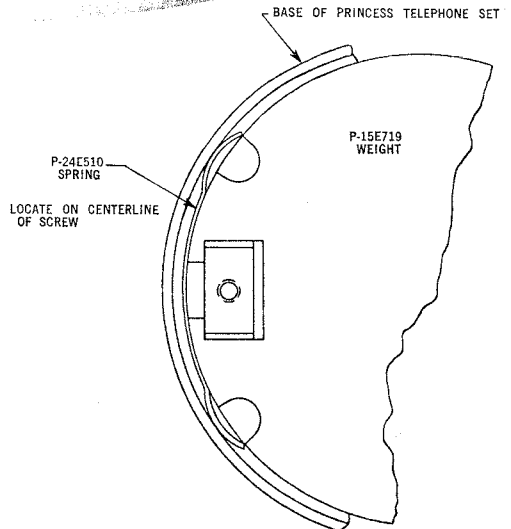


Fig. 18 — Location of P24E510 Spring



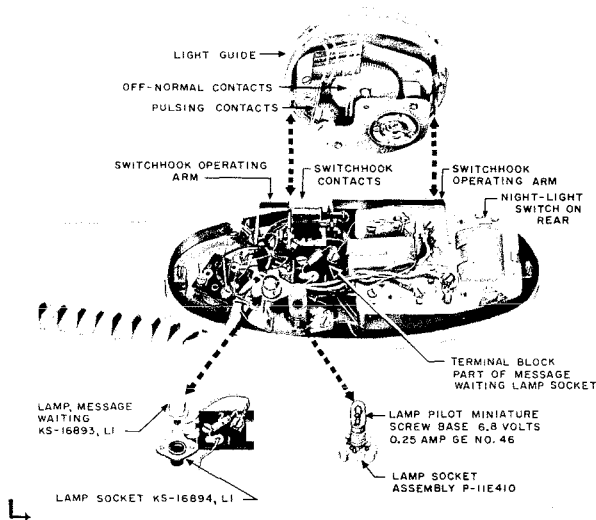
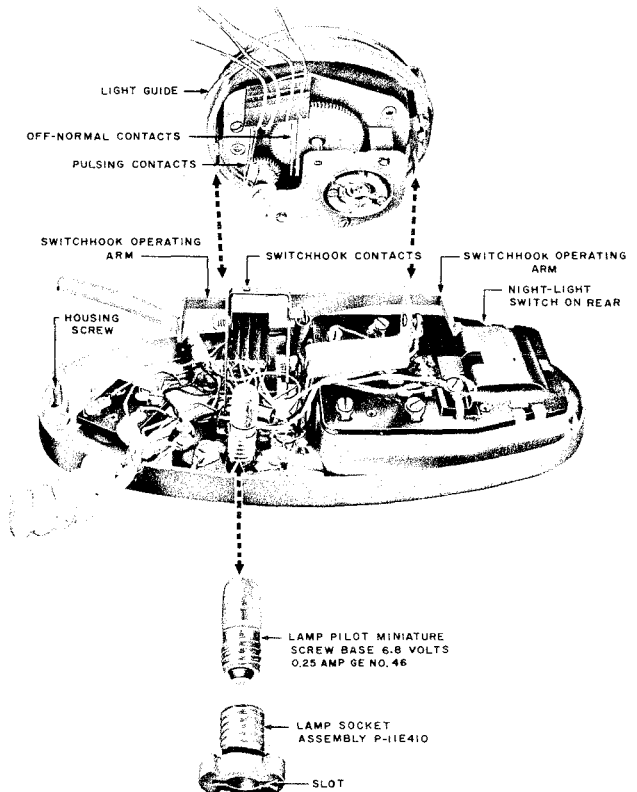


Fig. 19 — 701D Telephone Set with Dial and Lamp Socket

Fig. 20 — 701B Telephone Set with Dial and Socket Removed





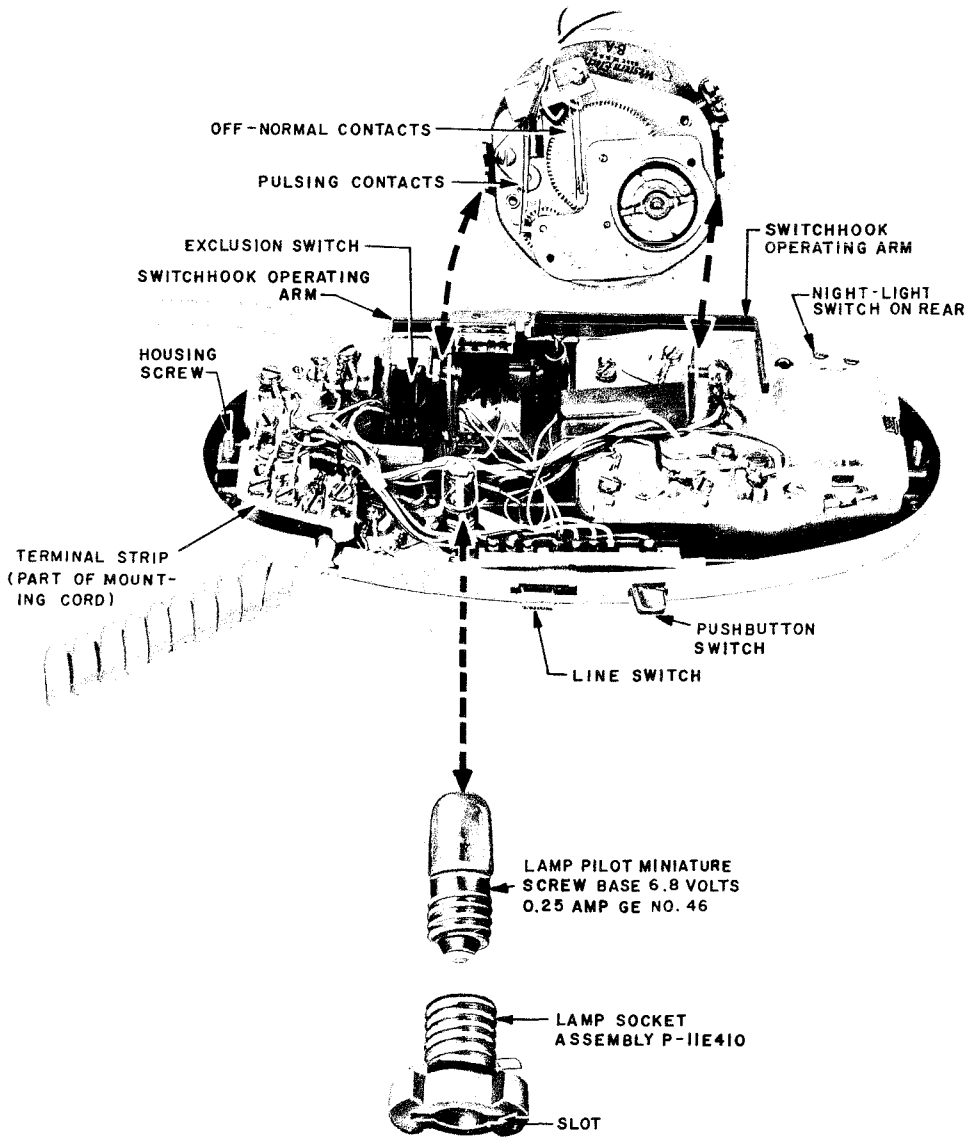


Fig. 21 — 711B Telephone Set with Dial and Socket Removed

#### 4. MAINTENANCE

**4.01** Maintenance of the 700-series PRINCESS telephone sets is limited to replacing defective components (Table A) and burnishing or adjusting switch hook contacts.

**4.02** Refer to sections covering dials, handsets, cords, ringers, networks, line keys, etc., for maintenance of these components.

**4.03** Housings, dial plates, and handsets may be cleaned with a damp KS-2423 cloth. *Do not use scouring cleaners or colored components as this may damage finish.*



*When coloured parts are replaced, make certain that the new parts match in colour the remaining parts of set. If unable to match, replace entire set.*

#### Quick Connect Terminals



**4.04** The 702 type telephone uses a quick-connect terminal into which the cord conductor spade tips are inserted. Whenever the telephone set housing is removed for maintenance, the tightness of these connections should be checked. If found to be loose, the terminal slot may be forced closed by using longnose pliers. When inserting or removing spade tips from quick-connect terminals, longnose pliers must be used. For detailed instructions, see para. 3.02 and Fig. 10 & 11.

#### Dial Light

**4.05** Slide switch for night-light operation is located on rear of base. Night light (reduced illumination) is obtained with switch operated to the left and handset in place. When handset is removed, dial light increases in brilliance for dialing purposes.

- With switch operated to the right, lamp will light only when handset is removed.

**4.06** The following points should be checked if lamp fails to operate:

- Loose connections.

- Defective lamp.

- Defective or unplugged transformer. Use 2A Clamp if it is necessary to secure 2012A transformer.

- Switchhook contacts dirty or improperly adjusted.

- Defective slide switch.

- Commercial power failure.

**4.07** If illumination is poor, check that the length of wire between transformer and telephone set does not exceed limits shown in Section covering station transformers. Only one dial light is allowed per 2012A transformer.

**4.08** The lamp socket assembly, with the lamp, is easily removed through the base of the set. It is not necessary to open the set for lamp replacement. (See Fig. 19, 20 and 21.)

#### Sliding While Dialing

**4.09** When a Princess (701 type) is encountered on a customer's premises it shall be checked (by lifting) to determine if a balancing weight has been inserted.

**4.10** If no weight has been inserted, remove the telephone housing, dress the leads and spade tips to provide space and clearance for a P-15E719 weight. Insert weight and a spring as shown in figures 16, 17 and 18 and Para 3.17 and 3.18.

**4.11** Verify with the customer or principal user of the telephone that the extra weight is not objectionable for their particular application. Where serious objections are raised, remove the P-15E719 lead weight.

**4.12** The 702BQ1A being equipped with an M1A ringer, eliminates the necessity of providing the P-15E719 weight and this, combined with a redesigned base pad, greatly improves the stability of the telephone set.

#### Insufficient Ringer Volume

**4.13** If the E1A Ringer is located on a baseboard behind furniture, suggest a change of location for the ringer.

## SECTION 502-710-101CA

**4.14** If relocating the ringer does not produce sufficient sound, a 687A Subscriber Set may be used instead. This subset contains the same C4A ringer as is used in the 500 type telephone.

**4.15** In the case of poor ringer volume on a 702BQ1A Princess telephone set, check to see that the M1A ringer is operating satisfactorily, (see section on Ringers M1A) and if not, replace the ringer.

### Spacer Washer on 702-Type Telephones

**4.16** On early models of 702-type telephones, the bracket at the right hand end of the base, which carries the captive housing retaining bolt, was formed slightly low. Such brackets have a steel washer around the bolt between the bracket and the housing. These brackets can be recognized by their square end. Care should be taken to retain this washer when the set is opened and to put it in place when the set is closed. Brackets, on which the square corners have been sheared off, were formed correctly and do not require the washer.

## TELEPHONE SETS—701B CONNECTIONS

### 1. GENERAL

**1.01** This section is reissued to delete tables for Inductive Noise. This information is covered in a section on Inductive Noise.

**1.02** The following figures and tables give the connection information for the 701B telephone set for the conditions shown.

	Fig.	Table
• Without Ringer, or Portable	1	A
	2	
• With E-Type Ringer	3	B
• With QCY1A1 Bell Chime		C
• Wired for 1A1 Key Telephone System	4	
• Wired for 3A Speakerphone	5	D
• With 687A Subset	6	E

**1.03** For tip-party identification when no ringer is used, a 1635A inductor is installed in

the telephone set. For information on installation of the inductor see section on Identification, Installation and Maintenance of 701 Type Telephone Sets.

**1.04** To convert the 701B telephone set from dial to manual, move two spade-tipped leads as follows:

- *S-W* from terminal F of network to terminal RR.
- *W* dial lead from terminal GN of network to terminal R1.

The dial remains on the set.

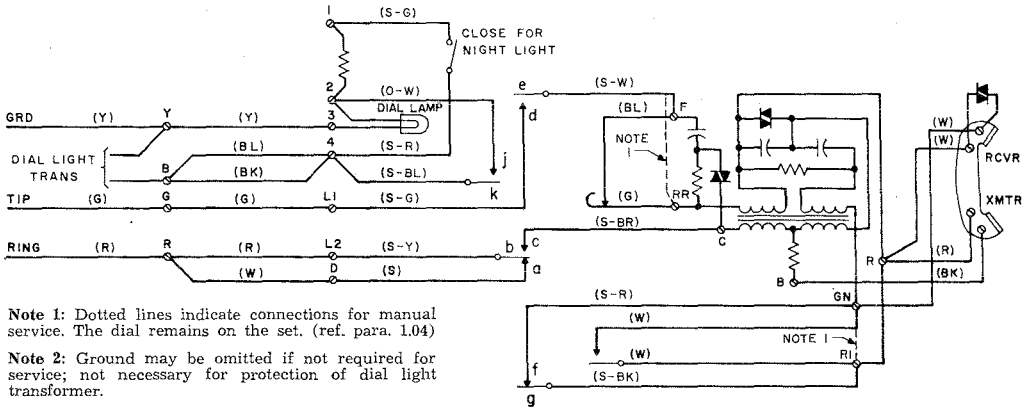


*The dial light transformer can be damaged by lightning if a sufficient difference in ground potential occurs between the telephone plant and the power system. Be sure that the telephone and power grounds are bonded in accordance with the section entitled Protector and Signaling Grounds.*

**1.05** **INDUCTIVE NOISE:** For equipment and connections see section entitled Inductive Noise.

SECTION 502-710-400CA

INSIDE WIRING      CONN BLOCK OR JACK      MTG CORD\*      TERM. STRIPS      SWITCH ASSEMBLY      DIAL 8A      NETWORK 495A      HAND SET G3AR



Note 1: Dotted lines indicate connections for manual service. The dial remains on the set. (ref. para. 1.04)

Note 2: Ground may be omitted if not required for service; not necessary for protection of dial light transformer.

\* For portable installations use D4BJ Cord (BL and W conductors not required)

Fig. 1 — 701B Telephone Set without Ringer, or Portable

TABLE A  
CONNECTIONS FOR TELEPHONE SET WITHOUT RINGER

Wire or Lead		Individual or Bridged	Ring Party	Tip Party
Line Wire at Conn Block	Ring	R	R	R
	Tip	G	G	G
	Grd	Y	Y	Y
Transformer Leads at Conn Block	1	Y	Y	Y
	2	B	B	B
		R	R	G
Mounting Cord at Conn Block	G	G	G	R
	Y	Y	Y	Y
	BL	B	B	B
	W	R	R	G
	BK	B	B	B
		R	L2	L2
Mounting Cord at Set	G	L1	L1	L1
	Y	3	3	3
	BL	4	4	4
	W	D	D	D
	BK	4	4	4
		BK		3
*Inductor Leads at Set	R			TAPE
	S			B

\* Required for Tip Party Ident. Grd. 2500Ω

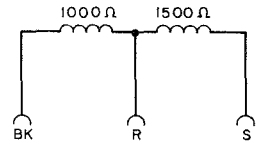


Fig. 2 — Inductor Connections

INSIDE WIRING      EIA RINGER      MTG CORD      TERM. STRIPS      SWITCH ASSEMBLY      DIAL 8A      NETWORK 495A      HAND SET G3AR

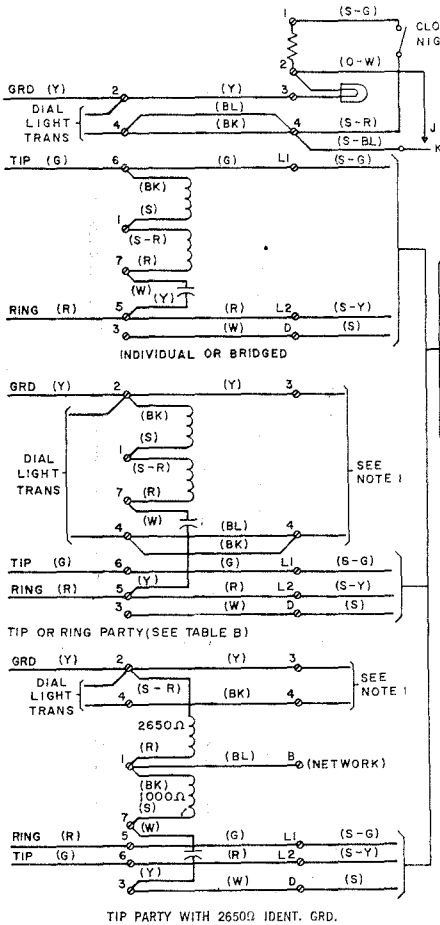
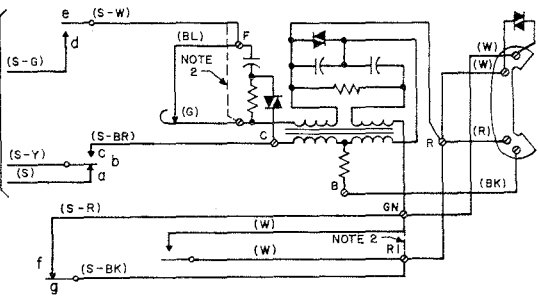


Fig. 3 - 701B Telephone with EIA Ringer

**Note 1:** To dial lamp circuit as shown for individual or bridged.

**Note 2:** Dotted lines indicate connections for manual service. The dial remains on the set. (ref. to para. 1.04)

**Note 3:** Ground may be omitted if not required for service not necessary for protection of dial light transformer.



**TABLE B**  
LINE AND RINGER CONNECTIONS WITH EIA RINGER

Line at Ringer	Wire or Lead		Individual or Bridged	Ring Party	Tip Party	Tip Party with Ident. Grd. 2650Ω
	Ring	Tip	R			
Line at Ringer	Ring		R	5	5	5
	Tip		G	6	6	6
	Grd		Y	2	2	2
Ringer			R	7	7	7
			S-R	1	1	1
			BK	6	2	2
			S	1	1	1
Capacitor in Ringer		W	7	7	7	
Transformer Leads		Y	5	5	6	
Mounting Cord at Ringer			1	2	2	2
			2	4	4	4
			R	5	5	6
			G	6	6	5
			Y	2	2	2
			BL	4	4	4
			W	3	3	3
Mounting Cord at Set*			BK	4	4	4
			R	L2	L2	L2
			G	L1	L1	L1
			Y	3	3	3
			BL	4	4	B
		W	D	D	D	
		BK	4	4	4	

\* Set wired at factory for individual or bridged, ring-, and tip-party service.

TABLE C  
CONNECTIONS WITH QCY1A1 BELL CHIME

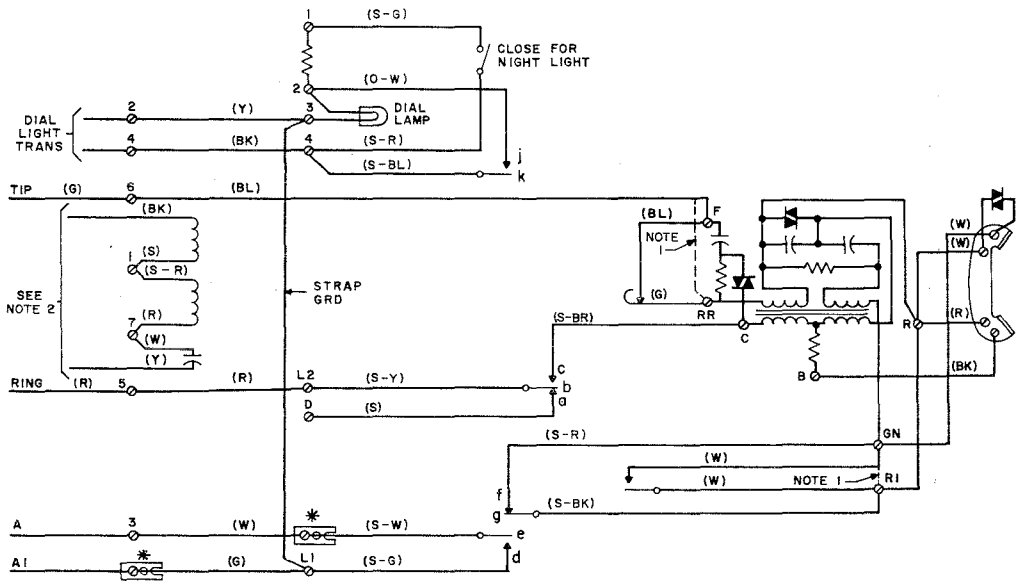
Location	Wire or Lead		Individual or Bridged	Ring Party	Tip Party	Tip Party with Ident. Grd. 2650 $\Omega$	
QCY1A1 Bell Chime Term.	Line	Ring	R	6	6	1	1
		Tip	G	4	1	6	5
		Grd	Y	1	4	4	4
	Ringer Coil		R	7	7	7	2
			S-R	2	2	2	4
			BK	4	4	4	2
			S	2	2	2	7
	Network Straps	G	BL	4	4	4	4
		A	R	7	7	7	7
		B	G	6	6	6	6
	Dial Light Trans		1	1	4	4	4
			2	3	3	3	3
	Mounting Cord		R	6	6	1	5
			G	4	1	6	1
			Y	1	4	4	4
			BL	3	3	3	2
			W	5	5	5	6
		BK	3	3	3	3	
Set Term.	Mounting Cord*		R	L2	L2	L2	L2
			G	L1	L1	L1	L1
			Y	3	3	3	3
			BL	4	4	4	B
			W	D	D	D	D
			BK	4	4	4	4



The QCY1A1 Bell Chime is not intended to be used with 4-party selective or 8-party semi-selective service, or any other service where code ringing would not be distinguishable in CHIME position. For schematic drawing and maintenance information on Bell Chime, see section entitled "QCY1A1 Bell Chime".

\* Wired at factory for individual or bridged, ring-, and tip-party service.

INSIDE WIRING      EIA RINGER      MTG CORD      TERM. STRIPS      SWITCH ASSEMBLY      DIAL BA      NETWORK 495A      HAND SET G3AR



*To prevent false holding condition when handset is restored, switch contacts cb must break before de breaks.*

**Note 1:** Dotted lines indicate connections for manual service. The dial remains on the set. (ref. to para. 1.04)

**Note 2:** For individual line ringer, connect BK to tip (6) and Y capacitor lead to ring (5). For common audible ringer, connect to signal leads from equipment cabinet using D-161488 connectors.

**Note 3:** Ground may be omitted if not required for service; not necessary for protection of dial light transformer.

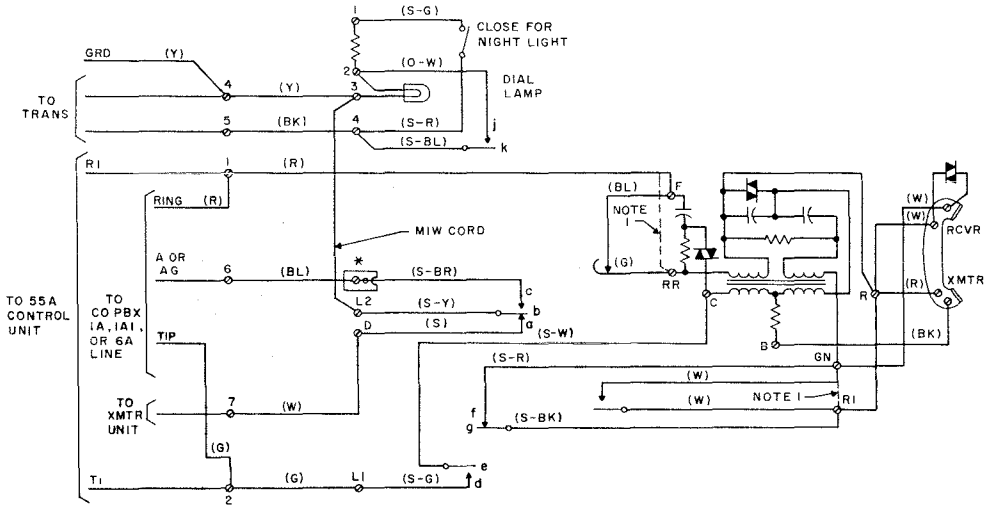
\* Connect with D-161488 connector.

**Fig. 4 — 701B Telephone Set Wired for 1A1 Key Telephone System**



SECTION 502-710-400CA

INSIDE WIRING    CONN BLOCK    MTG CORD    TERM. STRIP    SWITCH ASSEMBLY    DIAL 8A    NETWORK 495A    HAND SET G3AR



*To prevent false holding condition when handset is restored, switch contacts cb must break before de breaks.*

**Note 1:** Dotted lines indicate connections for manual service. The dial remains on the set. (ref. to para. 1.04)

**Note 2:** Ground may be omitted if not required for service; not necessary for protection of dial light transformer.

\* Connect with D-161488 connector.

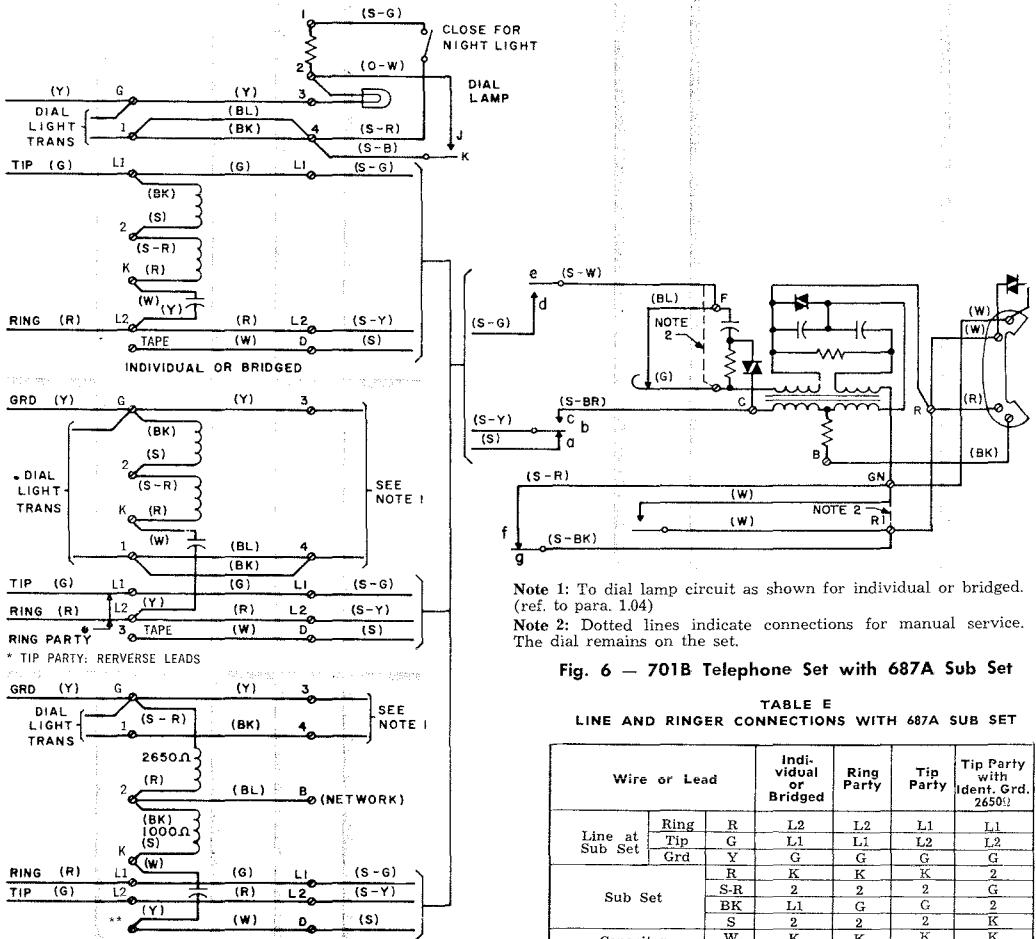
**Fig. 5 — 701B Telephone Set Wired for 3A Speakerphone**

**TABLE D  
701B MODIFICATION TELEPHONE SET  
FOR 3A SPEAKERPHONE**

Lead	From	To
BL Mtg Cd	4	D Conn (S-BR)
(S-BR) Swhk	C	BL Mtg Cd D Conn
R Mtg Cd	L2	F
(S-W)	F	C

*Note:* Strap 3 to L2 term. strip.

INSIDE WIRING      687A SUB SET      MTG CORD      TERM. STRIPS      SWITCH ASSEMBLY      DIAL 8A      NETWORK 495A      HAND SET G3AR



Note 1: To dial lamp circuit as shown for individual or bridged. (ref. to para. 1.04)  
 Note 2: Dotted lines indicate connections for manual service. The dial remains on the set.

Fig. 6 — 701B Telephone Set with 687A Sub Set

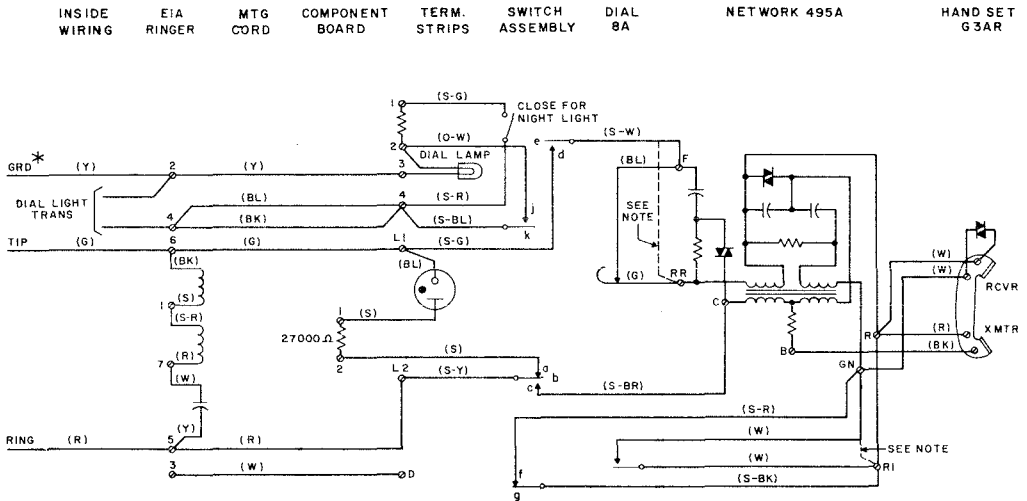
TABLE E  
 LINE AND RINGER CONNECTIONS WITH 687A SUB SET

Wire or Lead		Individual or Bridged	Ring Party	Tip Party	Tip Party with Ident. Grd. 2650Ω†
Line at Sub Set	Ring	R	L2	L2	L1
	Tip	G	L1	L1	L2
	Grd	Y	G	G	G
Sub Set	R	K	K	K	2
	S-R	2	2	2	G
	BK	L1	G	G	2
	S	2	2	2	K
Capacitor in Sub Set	W	K	K	K	K
	Y	L2	L2	L2	**
Transformer Leads at Sub Set	1	G	G	G	G
	2	1	1	1	1
Mounting Cord at Sub Set	R	L2	L2	L2	L2
	G	L1	L1	L1	L1
	Y	G	G	G	G
	BL	1	1	1	2
	W	†	†	†	**
Mounting Cord at Set*	BK	1	1	1	1
	R	L2	L2	L2	L2
	G	L1	L1	L1	L1
	Y	3	3	3	3
	BL	4	4	4	B
	W	D	D	D	D
	BK	4	4	4	4

\* Wired at factory for individual or bridged, ring- and tip-party service.  
 † Insulate and store.  
 \*\* D161488 Connector.



TELEPHONE SETS  
701D  
CONNECTIONS



Note: For manual service, remove lead from Terminal F and connect to RR and remove white dial lead from Terminal GN and connect to R1.

\* Ground may be omitted; not required for protection of dial-light transformer.

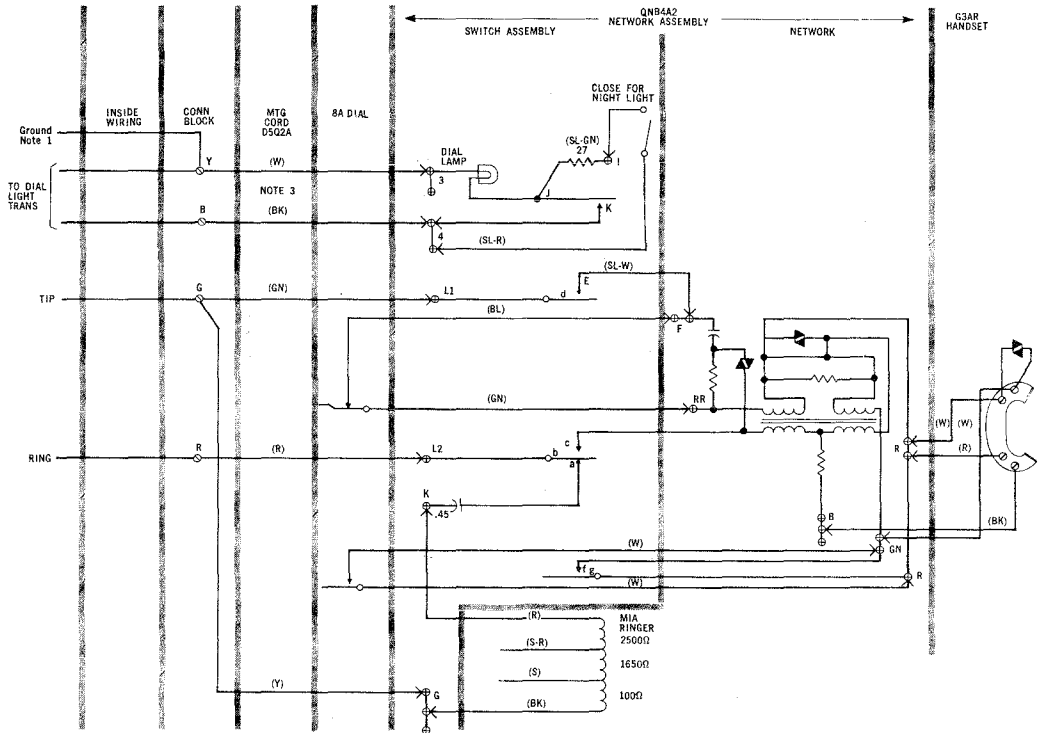
Fig. 1 — Connections for 701D Telephone Set

TABLE A  
LINE AND RINGER CONNECTIONS

WIRE OR LEAD		Individual or Bridged	WIRE OR LEAD	INDIVIDUAL OR BRIDGED
Line at Ringer	Ring	R	5	2
	Tip	G	6	4
	Grd	Y	2	3
Ringer		R	7	4
		S-R	1	
		BK	6	
		S	1	
Capacitor in Ringer		W	7	
		Y	5	
Transformer Leads at Ringer		1	2	
		2	4	
Mounting Cord at Ringer		R	5	
		G	6	
Mounting Cord at Set				R
				G
				Y
				BL
Message-Waiting Lamp Leads				W
				BK
				S
				BL



## TELEPHONE SET 702BQ1A CONNECTIONS



**Fig. 1 — 702BQ1A Telephone Set Equipped With QNB442 Network (Early Production) — Connections**

Note 1 Ground may be omitted if not required for service; not required for protection of dial light transformer.

Note 2 See Table A for line and ringer connections.

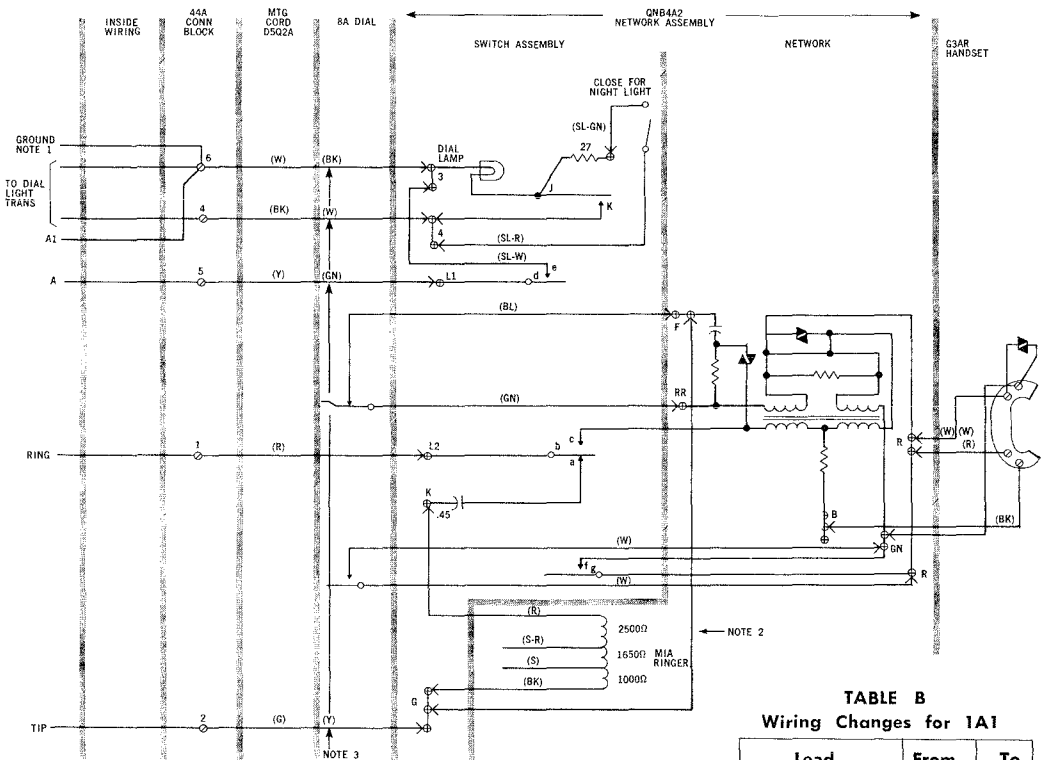
Note 3 When D6AB cord is used for replacement, it may be necessary to interchange these leads to obtain required conductor length.

TABLE A

Leads			Party			Tip Party With 2650 Ident. Grd.
			Individual	Ring	Tip	
Line	Ring	CONNECTING BLOCK	R	R	R	R
	Tip		G	G	G	G
	GRD		—	Y	Y	Y
Transformer	1		Y	Y	Y	Y
	2		B	B	B	B
Mounting Cord	R		R	R	G	G
	G		G	G	R	R
	Y		G	Y	Y	Y
	W		Y	Y	Y	Y
	BK		B	B	B	B
Ringer	R	CONNECTIONS IN TEL SET	K	K	K	K
	BK		G	G	G	G
	S		*	*	*	*
	S-R		*	*	*	B
Mounting Cord	R		L2	L2	L2	L2
	G		L1	L1	L1	L1
	Y		G	G	G	G
	W		3	3	3	3
	BK		4	4	4	4

\* Furnished insulated and stored on sets of later manufacture, or on S (spare) terminals. For ANI service connect as above.

Note: To permanently silence the ringer in all instances except when Tip-Party identification is required, move R lead from terminal K to G. When Tip-Party identification is in use, remove R lead from terminal K, tape and store. All other ringer leads must remain connected in accordance with the table for party identification.



**TABLE B**  
Wiring Changes for 1A1

Lead	From	To
Circuit Board	SL-W	F 3
Circuit Board	Strap	G F

**Fig. 2 — 702BQ1A Telephone Set (Equipped With QNB4A2 Network, Early Production) Used With 1A1 Key Telephone Systems**

Note 1 Ground may be omitted if not required for service; not required for protection of dial light transformer.

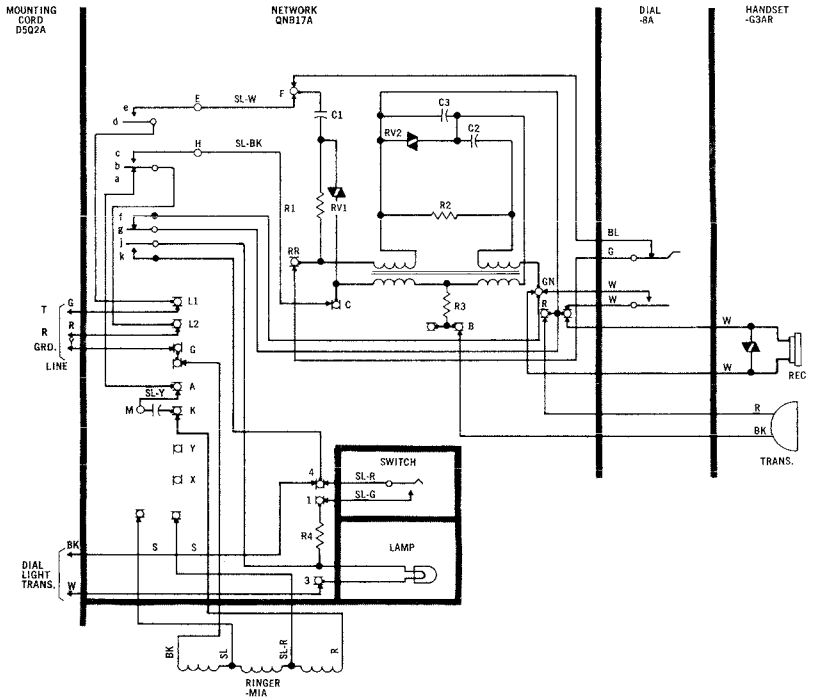
Note 2 Use M1W cord or strap with inside wiring cable conductor.

Note 3 When D6AB cord is used for replacement the colour code arrangement must be used as shown.

\* To prevent false holding condition when handset is restored, switch contacts *bc* must break before *de* breaks.



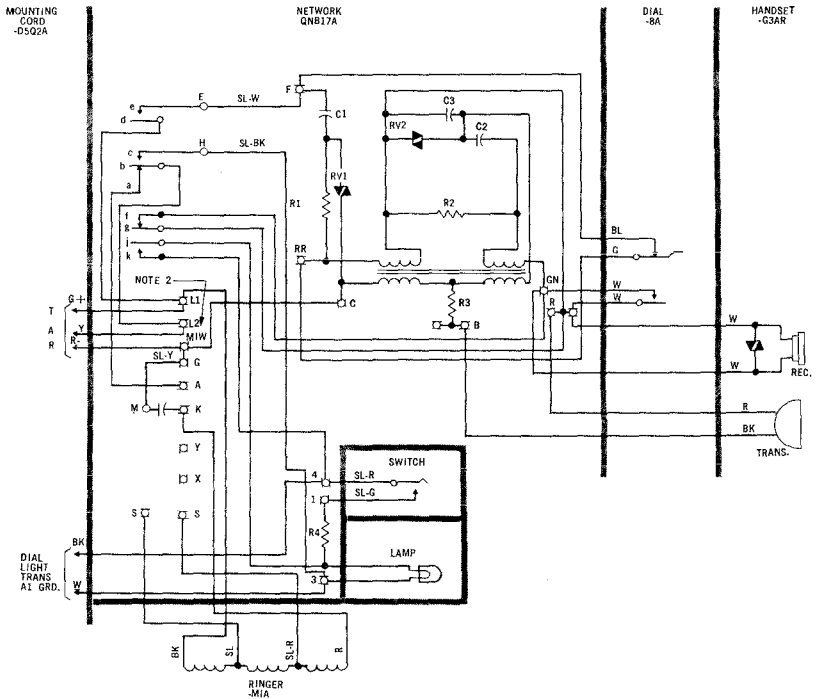
SECTION 502-710-403CA



NOTES:

1. When the handset is removed contact gf breaks last.
2. Ground may be omitted if not required for service: not required for protection of Dial Light Transformer.

Fig. 3 — 702BQ1A Tel. Set Equipped With QNB17A Network (Current Production)



**TABLE C**  
**Table of Wiring Changes**  
**for 1A1 or 1A2 KTS**

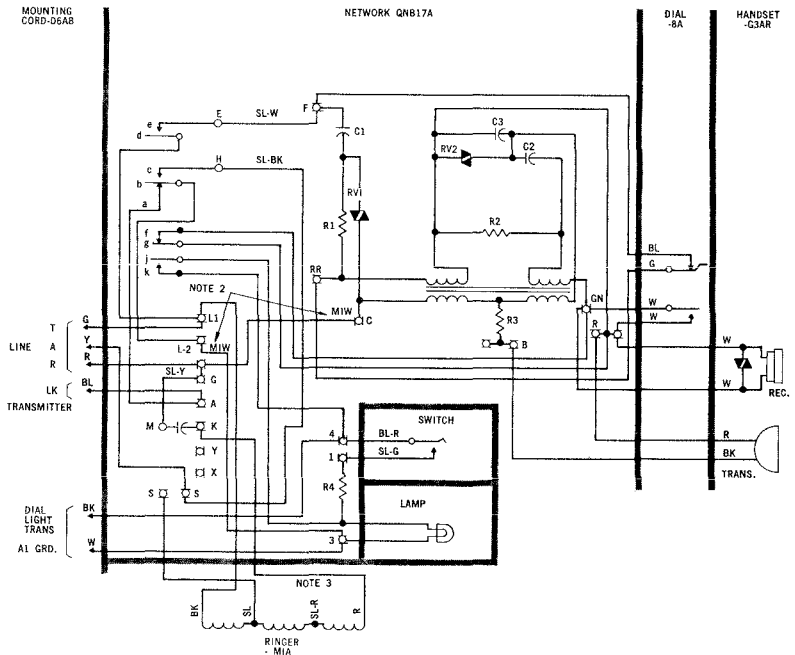
Lead	From	To	REF.
SL-BK	C	3	
BK	G	L <sup>1</sup>	
SL-Y	A	G	
STRAP	G	C	Note 2

**NOTES:**

1. When the handset is removed contact gf breaks last.
2. Use MIW Cord for strapping.
3. Ground may be omitted if not required for service: not required for protection of Dial Light Transformer.
4. To modify telephone set as shown in Fig. 4, rewire the set according to Table C.

**Fig. 4 – 702BQ1A Tel. Set Equipped With QNB17A Network (Current Production) Connections For 1A1 or 1A2 K.T.S.**

SECTION 502-710-403CA



NOTES:

1. When the handset is removed contact gf breaks last.
2. Use MIW Cord for strapping.
3. The SL and SL-R Ringer Leads are factory wired to terminals S and S. These terminals are spare. If use of these terminals are required for other wiring changes remove ringer leads, tape and store ensuring the stored leads are dressed to avoid interference with other components.
4. Ground may be omitted if not required for service: not required for protection of Dial Light Transformer.
5. To modify telephone set as shown in Fig. 5, rewire set according to Table D.

**TABLE D**  
**Table Of Wiring Changes**  
**For 1A1 or 1A2 KTS & 3A Speakerphone**

Lead	From	To	REF.
SL-R	S	—	Note 3
SL-BK	C	S	
BK	G	L <sup>1</sup>	
SL-Y	A	G	Note 2
STRAP	L <sup>2</sup>	3	"
STRAP	G	C	"

**Fig. 5 — 702BQ1A Tel. Set Equipped With QNB17A Network (Current Production) Connections For 1A1 or 1A2 K.T.S. And 3A Speakerphone.**

**TELEPHONE SETS — 711B**  
**CONNECTIONS**

**1. GENERAL**

**1.01** This section is reissued to remove connections for 1A home interphone, 2A farm interphone, and 3-type speakerphone systems which can be found in appropriate sections in Division 512. Since this reissue covers a general revision, arrows ordinarily used to indicate changes have been omitted.

**1.02** A ringer is not provided as part of the 711B telephone set. If a ringer is desired, see section covering E-type ringers and connect as required for type of service being provided.

**1.03** The 711B telephone set is not recommended for use in the following service:

- Automatic Number Identification (ANI)
- Tip party identification

- Inductive noise cancellation using cold cathode electron tubes.

**2. CONNECTION INDEX**

Table A — Modification for 1-Line Pickup, Cutoff Feature for Extension Station or External Line Ringer

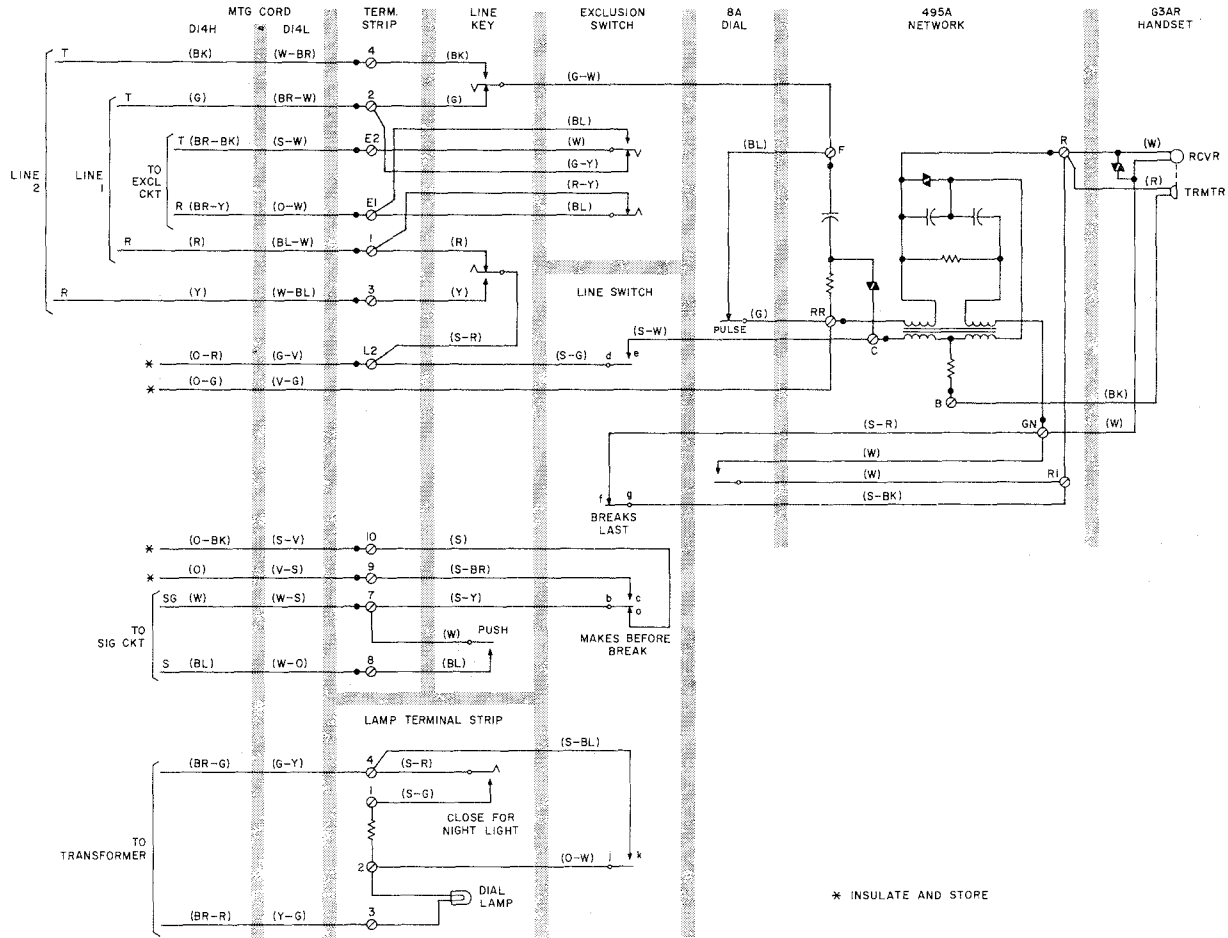
Fig. 1 — 711B Telephone Set — Wired for 2-Line Pickup, Exclusion on Line 1, and Signaling (Used Without 1A1 or 1A2 KTS)

Fig. 2 — 711B Telephone Set — Wired for 1-Line Pickup, Cutoff Feature for Extension Station or External Line Ringer

**TABLE A**

**MODIFICATION FOR 1-LINE PICKUP, CUTOFF FEATURE FOR EXTENSION STATION OR EXTERNAL LINE RINGER**

WIRE OR LEAD	COLOR	REMOVE FROM	CONNECT TO		INSULATE AND STORE
		TERM. STRIP	TERM. STRIP	NET.	
Line Key	(G)	2			●
	(R)	1			●
Exclusion Switch	(G-Y)	2			●
	(R-Y)	1			●
M1W Cord or Strap Wire			2 ← → F		
			1 ← → L2		



**Fig. 1 — 711B Telephone Set — Wired for 2-Line Pickup, Exclusion on Line 1, and Signaling (Used Without 1A1 or 1A2 KTS)**

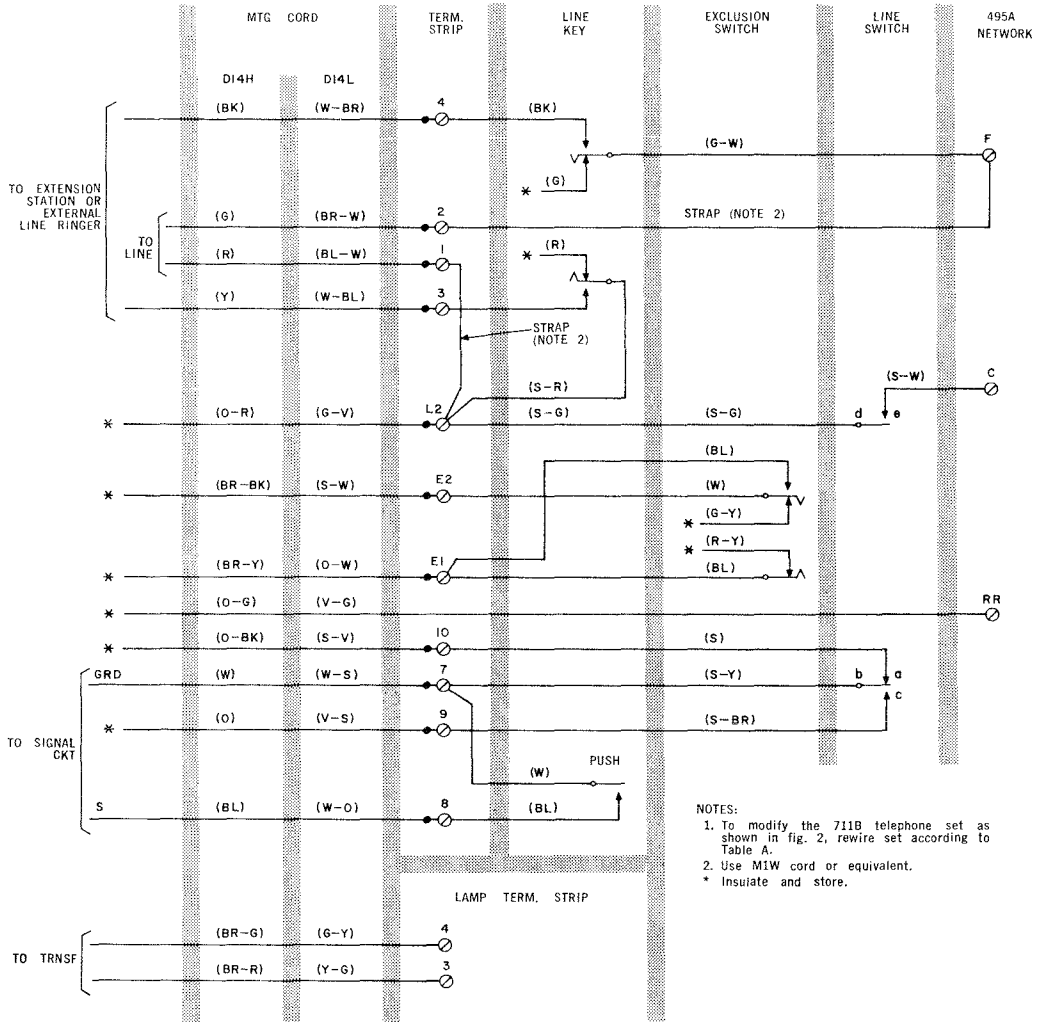


Fig. 2 — 711B Telephone Set — Wired for 1-Line Pickup, Cutoff Feature for Extension Station or External Line Ringer

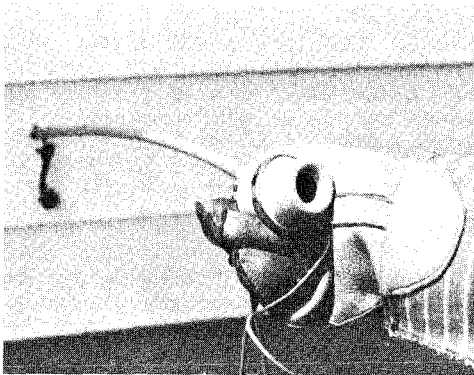


## OBSERVATIONS AND VOLTAGE TESTS TO BE MADE BEFORE WORKING AT JOINT USE POLES

CONTENTS	PAGE
1. GENERAL . . . . .	525
2. OBSERVATIONS TO BE MADE BEFORE CLIMBING . . . . .	525
3. VOLTAGE TESTS - VERTICAL POWER GROUND WIRES OR METALLIC POWER CONDUIT . . . . .	526
4. VOLTAGE TESTS AND SAFEGUARDS - POLES WITH STREET LIGHT FIXTURES . . . . .	527

**1. GENERAL**

**1.01** This section covers observations and tests to be made with the Z Voltage Tester before working on joint use poles to protect workmen against electrical shock from vertical power ground wires, metallic power conduit, or street light fixtures that may be energized.



**Fig. 1 — Gunsight Method**

**1.02** This section is reissued to illustrate the new method of holding the indicator and the probe in one hand (Gunsight Method) (See Fig. 1). This method will enable the workman to keep his eyes on the indicator at all times, and in case of high voltage that would burn out the indicator, he would see the glow before the indicator burns out and will not be mistaken and take the situation as a no voltage condition.

**1.03** The equipment required for the following tests is as follows:

Z Voltage Tester

B Voltage Tester Bag

Z Temporary Bond

B Shunting Capacitor

“E” Insulating Gloves

**1.04** The description, maintenance and care of the Z Voltage Tester and its attachments, is now covered in Section 106-220-925.

**1.05** *INSULATING GLOVES AND PROTECTIVE GLOVES SHALL BE WORN DURING THE COMPLETE TESTING PROCEDURE.*

**2. OBSERVATIONS TO BE MADE BEFORE CLIMBING**

**2.01** Examine the pole for potential hazards such as a vertical power ground wire, vertical metallic power conduit, or a street light fixture. Also observe the pole for such hazards as improper clearances from power conductors or equipment, dangling power wires, etc. If none of these is present, the pole may be climbed in accordance with safe climbing practices.



## SECTION 620-105-010CA

**2.02** If a vertical power ground wire is present, make a voltage test in accordance with Part 3 before climbing or working at the pole unless it meets one of the following conditions:

- (a) It can be clearly seen that the ground wire is bonded to a telephone cable strand, or
- (b) The ground wire is covered with wood molding, or equivalent, up through telephone space, and the ground connection is not broken, or
- (c) The ground wire is of the insulated type and the insulation is in good condition.

**2.03** If vertical metallic power conduit is present, make a voltage test in accordance with Part 3 before climbing or working at the pole unless it can be clearly seen that the conduit is bonded to the telephone cable strand.

**2.04** If a street light fixture is present, make a voltage test in accordance with Part 4, only if the pole also carries multiple line wire, telephone cable (including isolated cable), or a bare vertical power ground wire.

**2.05** Poles carrying street light fixtures may be worked on without making a voltage test under any of the following conditions:

- (a) The fixture is located in power space, or
- (b) The fixture is located ABOVE telephone attachments and it can be clearly seen that it is bonded to the telephone cable strand, or
- (c) The fixture is located BELOW telephone cable and it can be clearly seen that it is bonded to the telephone cable strand. However, in this case **INSULATING GLOVES SHALL BE WORN** in climbing the pole unless the wiring through and below telephone space is either 40 inches out from the pole surface or is otherwise made inaccessible.

**2.06** If a street light fixture is present in the telephone space on a pole not carrying a telephone cable or a bare vertical power ground wire, **WEAR INSULATING GLOVES AND AVOID CONTACT WITH IT OR ITS WIRING**, even though a voltage test has been made, since

it is not possible to place a temporary bond to an effective ground.

### **3. VOLTAGE TESTS - VERTICAL POWER GROUND WIRES OR METALLIC POWER CONDUIT**

**3.01** When a voltage test is required by Paragraph 2.02 or 2.03, proceed as follows before climbing or working on the pole.

(a) Attach the insulated clip of the voltage tester to one of the following:

- (1) A guy rod or telephone anchor guy. (Do not attach to an anchor rod that carries an uninsulated guy which is bonded to the power vertical ground wire.)
- (2) A fire hydrant, a projection on a man-hole cover, or a metallic curb box.
- (3) A 5-inch screwdriver blade pushed into the earth about 5 feet from the pole.
- (4) A substantial metal object such as a piece of lead sleeving, a metal crossarm brace, or a half-pound bar of D Seam Solder, etc, laid on the ground or pavement about 5 feet from the pole.

(b) Standing about 3 feet from the pole, grasp the insulated probe and the indicator assembly in one hand. Push the toothed metal disk at the end of the probe firmly against the ground wire or metal conduit being tested while looking into the open end of the indicator assembly.

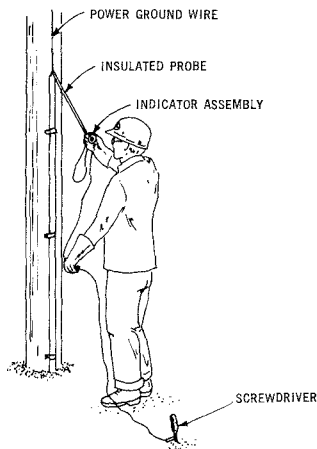
(c) **IF THE INDICATOR GLOWS, THE GROUND WIRE OR METAL CONDUIT IS ENERGIZED.** Immediately remove the probe from contact with the ground wire or metal conduit and notify your supervisor. **DO NOT CLIMB OR CONTACT THE POLE IF THE INDICATOR GLOWS.**

(d) If the ground wire is broken, test the **UPPER** part as described above, unless the break occurs above the telephone space. Do **not** attempt to test a broken ground wire if the break is observed to be in the power space. Report the broken power wire to your supervisor.

(e) If the lower 8 feet or so of the ground wire is protected with wood molding, test above the molding.

**3.02** If the voltage tester DOES NOT GLOW in making the test described in Para. 3.01, poles carrying vertical power ground wires and telephone cable may be climbed in accordance with safe climbing practice. Care should be exercised to avoid simultaneous contact between power ground wires and telephone cable or guys as a small voltage (60 volts or less) may be present. This is recommended to avoid the possibility of surprise shock which might (under some circumstances) cause a fall from the pole.

**3.03** After making the voltage test on a pole carrying vertical metallic power conduit or bare vertical ground wire and telephone cable, put on insulating gloves and place a Z Temporary Bond as follows. **FIRST ATTACH THE SMALL CLIP TO THE TELEPHONE STRAND;** then attach the large clip to the conduit (or a conduit fastening if the conduit is too large). **LEAVE THE BOND IN PLACE UNTIL ALL WORK OPERATIONS AT THIS POLE HAVE BEEN COMPLETED FOR THE DAY.** If the bond starts to smoke, put on insulating gloves and descend the pole. Avoid contact with the bond, the ground wire or the conduit and notify your supervisor and follow up with a B.T. Form 732.



**Fig. 2 — Testing Vertical Wire**

**3.04** On completion of work operations on the pole, remove the bond as follows:

- (a) Put on insulating gloves.
- (b) Remove the clip from the conduit. Remove this clip **FIRST**.
- (c) Remove the other clip from the strand.
- (d) If a spark is observed in removing the bond; notify your supervisor.

**3.05** If a shock is experienced as a result of an accidental contact between the ground wire or conduit and telephone cable, strand guy or other grounded objects, descend the pole at once and report the matter to your supervisor immediately.

#### **4. VOLTAGE TESTS AND SAFEGUARDS - POLES WITH STREET LIGHT FIXTURES**

**4.01** The B Shunting Capacitor is required under certain conditions in testing street light fixtures. In general, areas where it will be required will be known and workmen will be so equipped.

**4.02** Where a voltage test is required under conditions of Paragraph 2.04, proceed to test and safeguard the street light fixture as follows:

- (a) Attach B Voltage Tester bag containing test equipment to body belt.
- (b) Put on insulating gloves and climb to a convenient height to make the test. **AVOID CONTACTING THE LIGHT FIXTURE OR ITS WIRING.**
- (c) Attach the insulated clip of the voltage tester to the cable suspension strand, support bracket of urban or rural wires or a bare vertical power ground wire. Push the toothed metal disk firmly against the street light fixture while looking into the open end of the indicator assembly.
- (d) If the indicator glows, immediately remove the probe from contact with the fixture, then remove the insulated clip from its attachment. If a B Shunting Capacitor is not available, descend the pole and notify your supervisor. **AVOID CONTACT WITH FIXTURE OR ITS WIRING.** If a B Shunting Capacitor

is available, make a second test as described in subparagraphs (h), (i), and (j) following.

(e) If the indicator does NOT glow, contact the fixture with the probe again to be sure that good contact has been made. If the indicator still does not glow, place a temporary bond as described in (f) below.

(f) Attach the small clip of the Z Temporary Bond to the cable suspension strand or the bare power vertical ground wire so as not to be in the way of work operations. DO THIS FIRST. Then attach the other clip of the bond wire to the street light fixture. DO NOT BOND to the support bracket of multiple line wire or the suspension strand of ISOLATED cable.

**DO NOT ATTACH TO THE STREET LIGHT WIRES OR TERMINALS TO WHICH THEY ARE ATTACHED. NEVER ATTACH THE**

**CLIP TO A FIXTURE WHICH CAUSES THE INDICATOR TO GLOW.**

(g) The insulating gloves may be removed ONLY AFTER the temporary bond is in place, and then only if other protection requirements permit. LEAVE THE Z TEMPORARY BOND IN PLACE UNTIL ALL WORK OPERATIONS HAVE BEEN COMPLETED AT THIS POLE FOR THE DAY. If the bond starts smoking, put on insulating gloves and descend the pole immediately. Avoid contact with the bond, the fixture or its wiring. Notify your supervisor.

(h) If a B Shunting Capacitor is available, under the circumstances described in Subparagraph (d) preceding, make a second test as explained in the following paragraphs and Fig. 3.

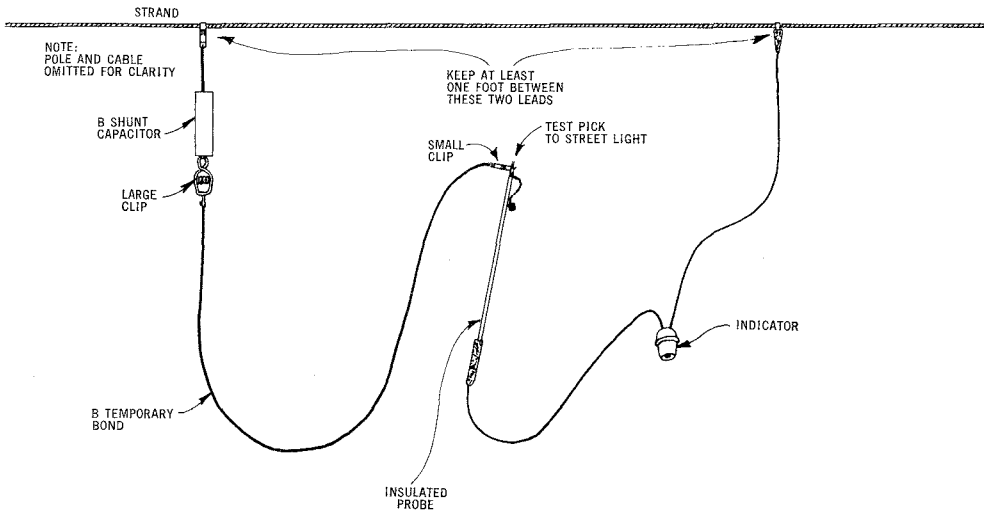


Fig. 3 — B Shunt Capacitor Connection Diagram

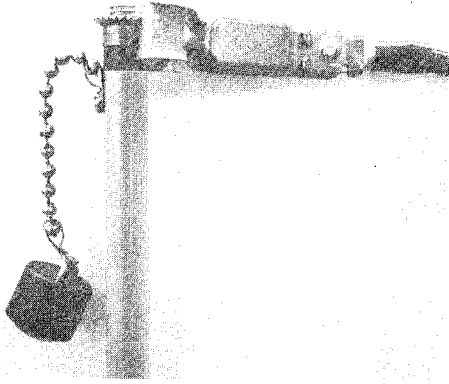


Fig. 4 — Bond Connection to Probe

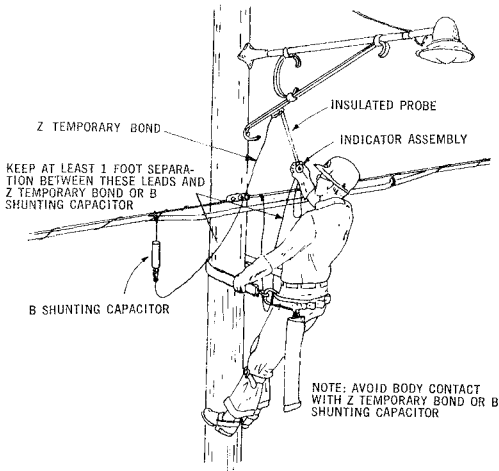


Fig. 5 — Testing Street Light

(1) Attach the clip of the voltage tester and the clip of the shunting capacitor to the cable suspension strand or to the bare power vertical ground wire.

(2) Attach the large clip of the temporary bond to the metal terminal of the capacitor and the other clip to the toothed metal disk of the insulated probe. (See Fig. 4).

(3) MAKE ATTACHMENTS IN (1) AND (2) ABOVE SO THAT AT LEAST 1-FOOT SEPARATION IS MAINTAINED BETWEEN THE LEADS OF THE VOLTAGE TESTER AND THE TEMPORARY BOND OR SHUNTING CAPACITOR.

(4) Touch the toothed metal disk or picks to the street light fixture while looking into the open end of the indicator assembly. (See Fig. 5) AVOID BODY CONTACT WITH TEMPORARY BOND OR CAPACITOR DURING TEST.

(i) IF THE INDICATOR GLOWS, THE FIXTURE IS ENERGIZED. Immediately remove the probe from contact with the fixture, replace testing equipment in the carrying case, descend the pole and notify your supervisor. AVOID CONTACT WITH THE FIXTURE OR ITS WIRING.

(j) If the indicator does not glow, contact the fixture with the probe again to be sure that good contact has been made. If the indicator still does not glow, place a temporary bond as described in Subparagraphs (f) and (g) preceding.

**4.03** On completion of work operations on a pole, remove the Z Temporary Bond as follows:

- (a) Put on insulating gloves.
- (b) Remove the clip attached to street light fixture. REMOVE THIS CLIP FIRST.
- (c) Remove the other clip from its attachment. If a spark is noticed on removing the bond, descend the pole immediately and notify your supervisor.



PRECAUTIONS TO BE TAKEN  
 BEFORE CLIMBING POLES OR WORKING FROM  
 STRAND- OR POLE-SUPPORTED EQUIPMENT

	CONTENTS	PAGE
1.	GENERAL . . . . .	531
2.	PRELIMINARY VISUAL EXAMINATION . . . . .	532
3.	RESULTS OF VISUAL EXAMINATION . . . . .	532
4.	PRINCIPLES TO BE OBSERVED . . . . .	532
5.	CONDITIONS WHICH REQUIRE NO TESTING OR SUPPLEMENTARY SUPPORT . . . . .	533
6.	PRECAUTIONS . . . . .	533

1. GENERAL

**1.01** This section, together with Sections 620-132-010 and 620-133-010, covers recommended procedures which will help prevent accidents associated with climbing and working on poles or strand-supported equipment. Observance of the principles and precautions in this section will help ensure the safe performance of work on poles.

**1.02** This section is reissued to modify the title, update the information and cancel the Appendix 1, Issue B. As this is a general revision, arrows normally used to show changes have been omitted.

**1.03** *All poles must be visually examined* before climbing, placing a ladder against pole or strand, hanging an aerial platform, or riding the strand.

**1.04** *Test all poles prior to climbing* as described in Section 620-132-010 unless they satisfy the conditions listed in Part 5 of this section.

**1.05** *All unsafe poles or poles of doubtful condition should not be climbed or should be climbed only after suitable temporary supports have been applied.* Section 620-133-010 describes methods of temporarily supporting poles.

**1.06** This section emphasizes the necessity for visual inspection and testing of poles and the need for temporary support of poles which may be unsafe. *Assure that the pole is safe.*

**1.07** All men who will work on poles or strand-supported equipment must be familiar with the recommendations contained in the Bell System Practices covering the use of:

- (a) Body belts
- (b) Safety straps
- (c) Climbers
- (d) Insulating gloves and other protective equipment.

**1.08** Pole failures may occur as a result of various causes. While poles that have been given an approved preservative treatment will usually retain their strength for many years, a treated pole may occasionally be encountered which will have a relatively short life because of an inadequate preservative treatment or other unusual conditions. Therefore, it is necessary to exercise care in checking the conditions of all poles, including those which appear to be sound. The failure of a pole is usually due to one or more of the following causes:

- (a) Decay of the pole at or below ground line.
- (b) Storm damage.
- (c) Mechanical damage, such as might result from a vehicle collision.

## SECTION 620-131-010CA

- (d) Termite, carpenter ant, or other insect attack.
- (e) Lightning damage or fire damage.
- (f) Woodpecker attack.
- (g) Application of excessive loads or creating unbalanced loads which are excessive under the existing conditions. These excessive loads may result from the use of improper or inadequate construction or maintenance methods.

### 2. PRELIMINARY VISUAL EXAMINATION

**2.01** Before climbing a pole or testing it for safe climbing conditions, make a visual check for the following conditions:

- (a) Excessive rake or unexplained leaning of a pole. This may be due to failure of the pole at or below ground line.
- (b) Insufficient depth of setting. This may be due to erosion of the earth around the pole as a result of heavy rainfall, flood water, road widening, etc., and would affect the stability of the pole. The depth of setting can frequently be checked by reference to the brand which is present on most poles at a distance of ten feet (measured to the bottom of the brand) from the butt of the pole. Do not rely upon the brand mark to determine the depth of setting of non-Bell Canada poles.
- (c) Evidence of collision damage if the pole is at an exposed location along a highway.
- (d) Presence of fungus growth in checks or protruding from the pole surface or on areas near ground line where the wood appears water-soaked in contrast to surrounding wood. These symptoms usually indicate a condition of advanced decay in the interior of the pole.
- (e) Presence of termite or carpenter ant infestation, evidence of mud channels or debris in the checks, wood dust at the base of the pole, or movement of ants when the pole is struck with a hammer or other tool.
- (f) Bent, loose, or missing pole steps.
- (g) Wide seasoning checks which could result in loosening of pole steps or a climbing hazard.

- (h) Evidence of compression wood indicated by short horizontal cracks along one side of the surface of the pole, or by curling of short sections out away from the pole surface.
- (i) Presence and distribution of large knots, excessive knot clusters, climber gaff splinters, unauthorized signs, aerials, clothes-lines, and nearby interfering tree growth.
- (j) Presence of large stones, ground irregularities, and debris at base of pole.
- (k) Presence of conduits or vertical runs on pole which might interfere with use of pole steps or climbing.
- (l) Broken wires in adjacent span.
- (m) Excessively tight or excessively slack drop or line wires on one side of pole.
- (n) Contact or insufficient separation between telephone and power wires or other plant on the pole, or in the span or spans adjacent to the pole.
- (o) Woodpecker holes.
- (p) Evidence of lightning or fire damage.
- (q) Presence of markings or hazard signal bands placed by pole inspector to indicate an unsafe pole or pole to be replaced.
- (r) Presence of ice on the pole surface or pole steps which might result in hazardous climbing.
- (s) Shell rot decay on cedar poles.

### 3. RESULTS OF VISUAL EXAMINATION

**3.01** If any conditions listed in Part 2 are found, they must be considered in connection with the results of the tests described in Section 620-132-010 and necessary precautions taken.

### 4. PRINCIPLES TO BE OBSERVED

**4.01** The most important principle to keep in mind is to *avoid placing an excessive unbalanced load on a pole*. Take into account the condition of the pole and the nature of the work operation which is to be performed.

**4.02** In planning a work operation involving a pole which may be unsafe, it is important to include temporary or permanent supports which will be effective in preventing failure of the pole.

**4.03** Under certain conditions described in Part 5, for minor work operations not involving the application of heavy unbalanced loads (Para. 5.02), poles can be climbed without being tested or applying additional supports.

## **5. CONDITIONS WHICH REQUIRE NO TESTING OR SUPPLEMENTARY SUPPORT**

**5.01** It is unnecessary to make tests or to apply a temporary support before climbing a pole if *any* of the following conditions will exist throughout the work operations:

- (a) The pole is storm guyed on four sides.
- (b) The pole carries two or more storm side guys and a load as described in Para. 5.02(b).
- (c) The pole is part of an H Fixture which is provided with head and back guys.
- (d) The pole is not in a straight section of a line, but is an adequately guyed corner pole and carries a load as described in Para. 5.02(b).

**5.02** It is also unnecessary to make tests or to apply a temporary support before climbing a pole if *all* of the following conditions exist throughout the work operations and the proposed work operations do not involve placing a heavy unbalanced load (excess of 150 pounds) on the pole:

- (a) The pole is in a straight section of line, but is not a dead-end pole.
- (b) The pole is carrying a 6M or larger suspension strand which is securely clamped to it and to each adjacent pole and will remain so attached throughout the work operations.
- (c) There is no downward change in grade at the pole.
- (d) Neither adjacent span length is in excess of 165 feet.

**5.03** It is also unnecessary to make tests or to provide supplementary supports before climbing a pole if the following conditions exist:

- (a) Instead of carrying a suspension strand, the pole carries ten or more copper, copper-steel, or steel line wires which will remain securely tied at the pole and at each adjacent pole throughout the work operation.
- (b) All the other conditions described in Para. 5.02(a), (c), and (d) exist.

**5.04** It is unnecessary to make tests before placing any strand-supported equipment if the following conditions exist:

- (a) The poles supporting the span and the poles at the far end of the adjoining spans form a straight section.
- (b) The suspension strand in the span is 6M or larger and is securely clamped to the two adjacent poles on each side of the span, and will remain attached to these four poles throughout the work operation.
- (c) There is no downward change in grade at the poles at each end of the span.
- (d) The span length and the adjacent span lengths are not in excess of 165 feet each.

## **6. PRECAUTIONS**

**6.01** An end pole in a line, even though head guyed, should always be examined and tested before climbing since the guy and the end spans do not contribute any stability to the pole in a direction across the line.

**6.02** *No work aloft should be started unless the workman is satisfied that the pole line structure has adequate strength to support the load resulting from working aloft and the load which will result from the proposed work operations. If the strength of the pole line structure is in doubt, temporary or permanent supports must be applied before starting work.*

**6.03** *Poles at each end of an aerial span in which a ladder is to be placed, an aerial platform hung, or a cable car ridden shall be visually examined as described in this section and tested as described in Section 620-132-010.*



## SECTION 620-131-010CA

**6.04** Temporary supports adequate to support the pole shall always be placed before removing any attachments from a pole that is to be removed or replaced because of deterioration.

**6.05** Swinging rapidly around a pole imposes an additional load on any pole and should be avoided.

**6.06** Where a work operation is planned which is likely to result in a shock load on a pole or on an adjacent pole, a workman should remain off the pole to avoid being shaken off by the shock load. If the shock load would be likely to break the pole, temporary guys should first be placed to take up the shock.

**6.07** *Heavy unbalanced loads, such as those caused by placing or removing conductors or strands under tension at unguyed poles or inadequately guyed corners or deadends, may cause even a pole in good condition to fail.*

Therefore it is important to plan the work operations so the poles will not be subjected to too heavy an unbalanced load. The use of guys or braces provides a means of preventing excessive unbalanced loads. Typical operations for which temporary or permanent supporting of poles may be required are as follows:

- (a) Removal of guys.
- (b) Untying wires.
- (c) Releasing wires or strand under tension.  
***Do not cut while under tension.***
- (d) Placing additional wires or strand.
- (e) Tensioning wires or strand.
- (f) Changing locations of wire or strand attachments.
- (g) Loosening suspension clamps or guy clamps.
- (h) Moving line because of road widening.

## SAFEGUARDS TO BE TAKEN BEFORE CLIMBING POLES TESTING POLES

CONTENTS	PAGE
1. GENERAL . . . . .	535
2. METHODS OF TESTING POLES . . . . .	535
3. BORING TEST . . . . .	537
4. HAND LINE METHOD . . . . .	537
5. REPORTING POLES FOUND TO BE UNSAFE FOR CLIMBING . . . . .	537
6. MARKING DEFECTIVE POLES . . . . .	538

### 1. GENERAL

1.01 This section covers methods of testing poles to determine whether or not they are capable of withstanding the loads to which they will be subjected in climbing and working on them.

1.02 This section is reissued to update the information. It also adds the Hazard Signal Bands previously contained in Section 620-131-910 which is hereby cancelled. As it is a general revision marginal arrows normally used to show changes have been omitted.

1.03 The following tests will provide important information in addition to that obtained in the visual examination described in 620-131-010. The necessary tests shall be made to determine whether the pole can be climbed safely.

1.04 *In any case where suitable means for determining the condition of a pole and bracing it when necessary are not available and there is any question about the pole being sufficiently*

*strong to permit safe climbing and safe working, do not climb the pole.* Inform your supervisor about the condition and request the necessary assistance to enable the work to be done safely. (refer to V61.026).

### 2. METHODS OF TESTING POLES

2.01 Each of the methods of testing listed below has certain limitations and may not be applicable under the conditions existing at certain locations. It is important, therefore, to make a selection of the tests that are applicable and most suitable under the existing conditions. The tests are as follows:

- (a) Pike Pole Test
- (b) Prod and Sounding Test
- (c) Boring Test
- (d) Hand Line Test

2.02 As pointed out in Section 620-131-010, the necessity for testing occurs principally under *any* of the following conditions.

- (a) At dead-end poles.
- (b) In longer span cable or open wire construction.
- (c) Where there is a downward change in grade at a pole.
- (d) Where the line is carrying a small number of telephone wires or both power and telephone wires.
- (e) Where drop wires are attached, especially where the pull from them is unbalanced.

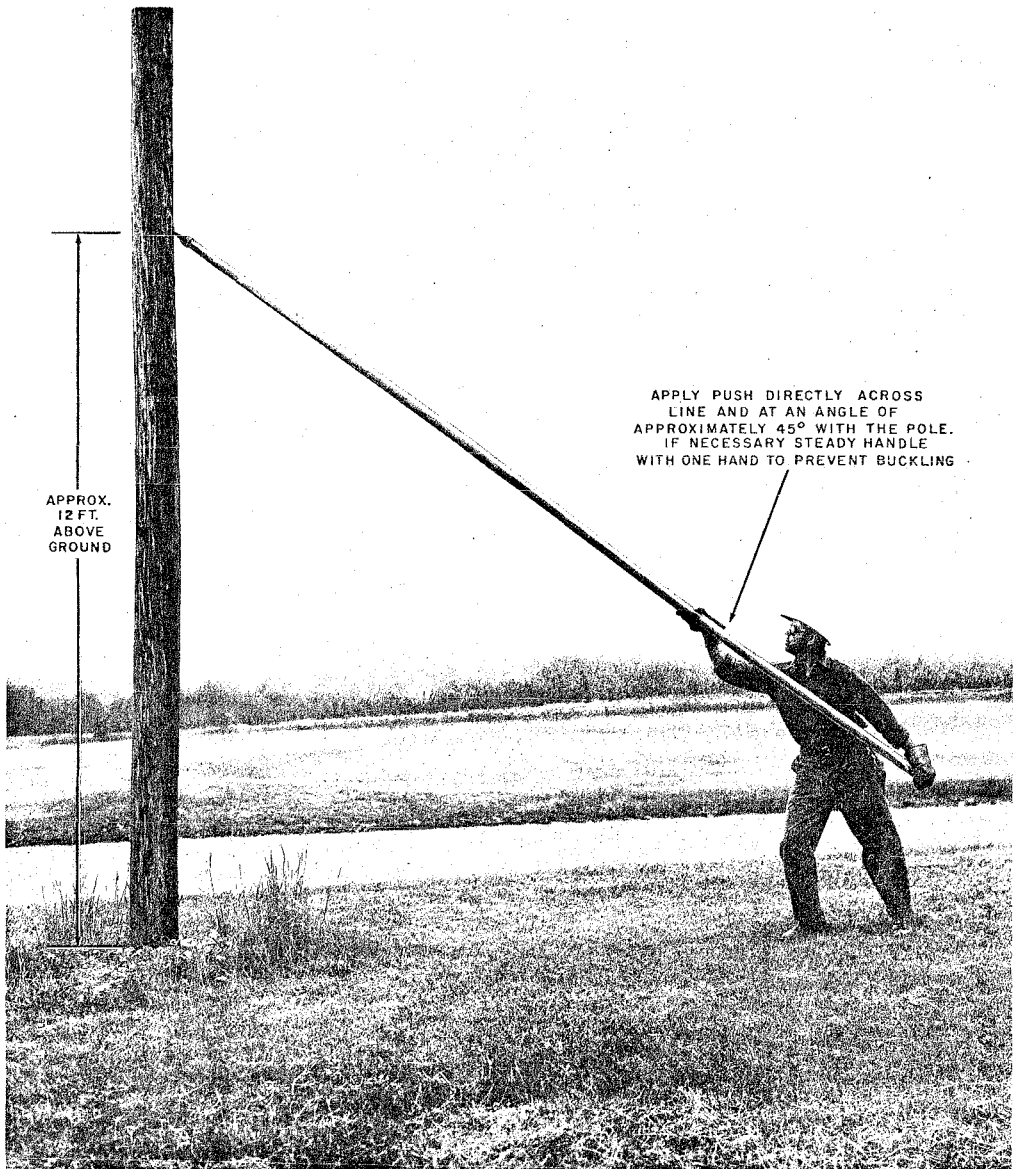


Fig. 1 — Pike Pole Test

**2.03** Inasmuch as the section of maximum decay is normally encountered between the ground-line and a point about 12 inches below the ground-line, it is desirable, if conditions permit, to excavate sufficient earth from around the pole to permit a more satisfactory examination of the pole. If, however, the pole is set in pavement, or for other reasons, it is impracticable to remove any earth, the prod should be applied as close to the ground-line as practicable, at an angle of approximately 45 degrees with the pole and completely around the pole. The presence of general sapwood decay or decay pockets will usually be evident from this test.

**2.04** If the prod test indicates the presence of extensive decay, it is desirable to apply temporary supports, regardless of the original circumference of the pole, unless in accordance with Section 620-131-010, no supports are required.

**2.05** If there is no indication of decay or other reduction of strength in the prod and sounding tests and the pole has been subjected to a moderate pike pole test where conditions permit its use, *25-foot or shorter poles* in straight sections of rural lines carrying eight or less 104 copper or stronger wires with no downward change in grade, and measuring 13 inches or more in circumference at the ground-line, may be climbed without placing temporary supports.

**2.06** The prod test is not considered as satisfactory as the pike pole test and it should not be completely depended upon to furnish information as to the soundness of the pole.

#### **ABOVE GROUND-LINE**

**2.07** The sounding test consists of applying blows with a hammer, such as a drilling hammer, or the back of a hand axe, to the pole surface completely around the pole from points close to the ground-line to as high as can conveniently be reached. The presence of a hollow heart condition or advanced internal decay can usually be recognized by the characteristic hollow or dull sound resulting from the blows on the wood. A pole free from decay usually sounds clear and the hammer usually rebounds noticeably when the pole is struck sharply and squarely. Wet surfaces due to recent rains, wet interior near the ground-line due to high soil moisture,

wide checks, or shakes in the pole near the surface may change the sound of a solid pole. Care must be taken not to mistake the altered sound due to these causes for the sound associated with internal decay.

#### **3. BORING TEST**

**3.01** The boring test consists of boring a hole in the pole at a point where internal decay is suspected by means of a 3/8 inch wood boring bit or by means of an increment borer. The condition of the wood can be determined by an examination of the chips or core brought out by the bit. The presence of a hollow heart condition is, of course, revealed by the bit breaking through the wood.

**3.02** If a hole is bored in a pole and it is concluded that the pole is in sound condition and the pole is to be left in place, the hole should be filled by means of a wooden plug. (Ordering information is as follows: Plug, Wooden. Plugs come in 3-inch lengths.

#### **4. HAND-LINE METHOD**

**4.01** The hand-line method consists of applying a series of pulls to a pole with the object of rocking the pole back and forth. In applying this test, use should be made of a 3/8 inch or larger rope, attached to the pole at such a height that the pull can be applied at right angles to the direction of the line and at an angle of about 45 degrees with the pole. The same use limitations and precautions applying to the pike pole test, apply also to this method of testing. In attaching the rope to the pole, the pole should not be climbed, but the rope should be thrown over a fixed attachment, such as a pole step or a crossarm, or a loop should be made at the base of the pole and moved into position by means of a convenient tool, such as a wire raising tool.

#### **5. REPORTING POLES FOUND TO BE UNSAFE FOR CLIMBING**

**5.01** Poles found by the previously described tests to be unsafe for climbing should be marked immediately with a Hazard Signal Band as described in Part 6. If a Band is not readily available, report the hazard promptly to the supervisor on Form 732, as per V61.026 so that necessary action can be taken.

**SECTION 620-132-010CA**

**5.02** If the pole has been broken, resulting in an unsafe condition and requiring immediate support, temporary supports should, if practicable, be applied immediately to prevent the pole from falling. If suitable bracing means are not available, steps should be taken to warn passers-by or traffic away from the location until a safe condition can be restored and a report of the condition should be made promptly to your supervisor.

**6. MARKING DEFECTIVE POLES**

**6.01** All poles which are recommended for replacement on account of deterioration or mechanical damage should be plainly marked to indicate that they are defective. Because of the transfer of personnel during storm breaks or other restoration work, the method for marking poles should be uniform throughout the Company.

**6.02** Three types of Hazard Signal Bands have been made available, namely Red, Yellow and Blue. Each of these types serve the purpose indicated below:

<b>Type</b>	<b>Purpose</b>
Red	To indicate a hazardous electrical condition overhead.
Yellow	To indicate a hazardous physical condition in the pole itself.
Blue	To serve the same purpose as the yellow band in municipalities where other utilities use yellow markings for other purposes.

**6.03** These bands consist of a piece of plastic-coated leatherette fabric 4 ft. long and 4 in. wide.

**6.04** Whenever a hazard is found to exist at a pole due to overhead clearances from power wires being less than specified in the 620 Division, or to the condition of the pole itself or an associated brace or guy, install the appropriate Hazard Signal Band when the hazard will not be cleared promptly by work in progress at that location. The presence of such a band serves as a warning to any employee who may be required to climb or work on the pole, as outlined in Section 620-131-010.

**6.05** When the appropriate Hazard Signal Band is not readily available and cannot be installed without delay, it should be installed as soon as practical after Part 5 has been followed.

**6.06** Locate the Hazard Signal Band around the pole with the bottom edge about 5 ft. above ground level.

**6.07** Attach the band near its top and bottom edges with Roofing Nails, or tacks to be obtained locally. Three or four nails or tacks per edge are recommended.

**6.08** When hazards which are marked by Hazard Signal Bands are cleared, remove the bands promptly.

## SAFEGUARDS TO BE TAKEN BEFORE CLIMBING POLES TEMPORARY SUPPORTS

	CONTENTS	PAGE
1.	GENERAL . . . . .	539
2.	PRECAUTIONS . . . . .	539
3.	METHODS OF APPLYING TEMPORARY SUPPORTS . . . . .	539

### 1. GENERAL

1.01 This section describes various methods of temporarily supporting poles.

1.02 The section is reissued to update information and to show new machinery.

1.03 Poles which have been found to be unsafe or are suspected of being unsafe for climbing or working on, shall either not be climbed at all or shall be climbed only after suitable temporary supports have been applied which will ensure safe climbing and working conditions. If suitable supports can not be provided with the equipment at hand, refer the case to your supervisor.

1.04 The following methods of supporting poles temporarily may be used:

- (a) Lashing old or weakened pole to new pole.
- (b) Supporting pole by means of pole derrick.
- (c) Temporary guying.

### 2. PRECAUTIONS

2.01 Where temporary supports are used to reinforce a pole, it is important that a workman should avoid climbing to a level more than 10 feet (measured to the workman's feet) above the point at which the temporary supports

are attached. If necessary to work at a greater height above existing supports, place additional supports at a point approximately 10 feet above those supports as shown on Page 2.



### 3. METHODS OF APPLYING TEMPORARY SUPPORTS

3.01 The various methods of supporting poles temporarily are described in detail in the following.

#### Lashing Weakened Poles to New Poles

3.02 A weakened or old pole should be supported by lashing it to a new pole, if the new pole is set within 3 feet of it, or if the new pole has been placed in the old pole hole. The two poles should be lashed together as shown in the following illustration.

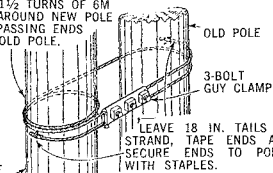
3.03 In order to place the upper lashing, climb the new pole. Do not, under any circumstances, work from the old pole until both upper and lower lashings have been completed. Rope

## SECTION 620-133-010CA

lashings should be used only where the old pole is to be removed within a reasonable period of time (usually a few days) or where there might otherwise be an electrical hazard in passing the sling around the poles.

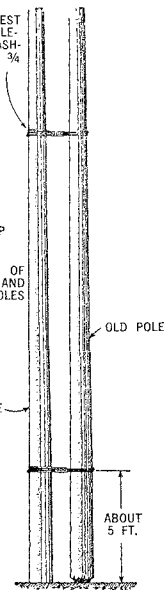
PLACE TOP LASHING AT LEAST 4 FT. BELOW NEAREST POWER CONDUCTOR ON JOINTLY USED POLE. ON TELEPHONE POLES (NO POWER ATTACHMENTS), PLACE LASHING AS HIGH AS CONVENIENT, BUT NOT LESS THAN  $\frac{3}{4}$  OF THE HEIGHT OF OLD POLE ABOVE GROUND.

DETAIL OF STRAND LASHING  
MAKE  $1\frac{1}{2}$  TURNS OF 6M STRAND AROUND NEW POLE BEFORE PASSING ENDS AROUND OLD POLE.

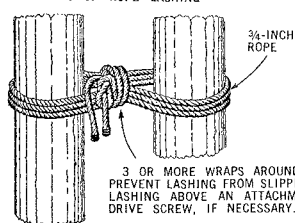


LEAVE 18 IN. TAILS OF STRAND, TAP ENDS AND SECURE ENDS TO POLES WITH STAPLES.

NOTE: 2200 POUND STRAND SECURED WITH ONE-BOLT CLAMP MAY BE USED WITH 30-FOOT AND SHORTER POLES.



DETAIL OF ROPE LASHING



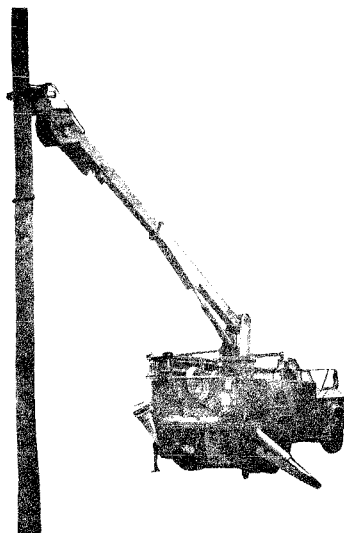
3 OR MORE WRAPS AROUND POLES. IN ORDER TO PREVENT LASHING FROM SLIPPING DOWN POLES, PLACE LASHING ABOVE AN ATTACHMENT OR A TEMPORARY DRIVE SCREW, IF NECESSARY.

### Supporting Pole by Means of Pole Derrick

**3.04** When the pole can be reached by truck, there are many advantages to supporting the pole by a derrick. Place the winch rope around the pole and raise it with a pike pole or wire raising tool to a point level with the top of the derrick sheave and pull it snug.

**3.05** The point of attachment of the winch line should, if practicable, be several feet or more above the balance point of the pole. The location of the balance point of a pole will vary with the taper and general shape of the pole. In a pole, such as a southern pine, which ordinarily has a uniform but small amount of taper, the balance point will be close to the midpoint of the pole. In a pole with a greater amount of taper or a heavy butt, the balance point will be some-

what lower. For example, in a 35-foot southern pine, Douglas fir or western larch pole (all of which normally have a small taper), the balance point will usually be 1 to 2 feet below the midpoint that is, about 19 feet below the top of the pole. In a 35-foot western cedar pole having a somewhat greater amount of taper or a heavy butt, the balance point may be two to three feet below the midpoint. It should be noted, however, that *the balance point of a pole broken off at the ground line is close to the midpoint of the portion of the pole projecting out of the ground* and that if the pole carries any plant such as wires or cable the balance point may be considerably higher, thus necessitating the use of supplementary rope guys as described in Para. 3.06.



**3.06** If it is not practicable to attach the winch line sufficiently above the balance point to ensure stability of the pole with a workman in position on the pole, temporary rope guys should be attached to the pole either close to the ground line or far enough above the winch line attachment to ensure the required stability.

### Use of Temporary Guys

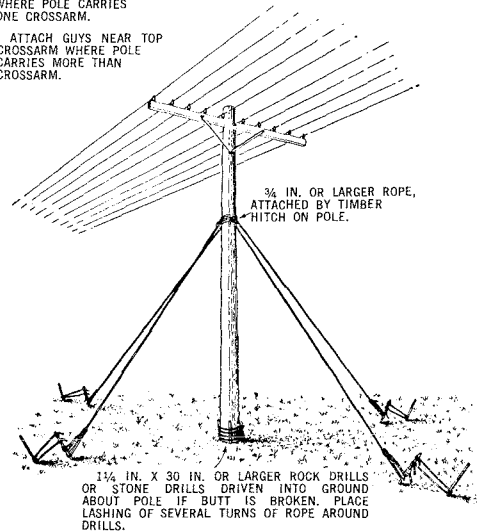
**3.07** Rope or strand guys may be used as shown in the following illustration. The temporary guys may be attached for anchorage purposes to other poles, trees or stumps that are in sound

condition, sufficiently strong and in the desired position for the attachment of the guys. Where such anchorages are not available, use can sometimes be made of one or more bars driven into the ground as described below. The number of bars required depends upon the load and soil conditions. The use of two bars for each guy is generally recommended, although one will be sufficient if the load to be supported is very light and the ground into which the bar will be driven is firm.

**3.08** To facilitate the operation of attaching the guys to the pole, it may be advantageous in some cases, to support the pole temporarily by three or four pike poles or a pole derrick. In other cases, the rope guys may be raised into position by means of a wire raising tool. ***Do not climb an unsupported questionable pole.***

ATTACH GUYS ABOUT 6 FT. BELOW CROSSARM WHERE POLE CARRIES ONE CROSSARM.

ATTACH GUYS NEAR TOP CROSSARM WHERE POLE CARRIES MORE THAN ONE CROSSARM.







## CLEARANCES AND SEPARATIONS FOR AERIAL COMMUNICATION PLANT

CONTENTS	PAGE
1. GENERAL . . . . .	543
2. VERTICAL CLEARANCES FOR COMMUNICATION WIRES AND CABLES . . . . .	545
— Above Ground or Railway Tracks . . . . .	545
— From Foreign Power or Communication Plant (Non Joint Use Construction) . . . . .	551
— From Swimming Pools . . . . .	551
— Above Buildings, Signs, Etc . . . . .	552
3. HORIZONTAL CLEARANCES AND SEPARATIONS FOR COMMUNICATION WIRES, CABLES, POLES AND STUB POLES . . . . .	552
— From Rails . . . . .	552
— From Power Wires Carried on a Separate Pole Line . . . . .	553
— Separation of Poles and Stub Poles from Fire Hydrants and Curbs . . . . .	553
— Wires and Cables Passing By (But Not Attached To) Buildings, Signs, Billboards, Lamp and Traffic Signs, Standards and Antennas . . . . .	553
4. CLEARANCES FOR GUYS . . . . .	553
— Communication Guys . . . . .	553
— Power Guys Attached to Poles Carrying Communication Wires and Cables . . . . .	554

### 1. GENERAL

1.01 This section provides the *minimum* clearances and separations to be used for aerial communication cables, line wires, drop wires, poles, stub poles and guys in Bell Canada territory, except for joint use clearances in the span and separations at the pole which are covered in 620-215-011CA. *It is recommended that these values be increased where conditions permit.*

1.02 The term *clearance* as used in this section means the shortest distance existing between two objects, at least one of which is free to move, when there is no wind or ice. *Separation* is the shortest distance existing between two fixed objects (see Figure 1).

1.03 The clearances and separations shown in this section meet or exceed the requirements for the Heavy Loading Area of CSA Standard C22.3 No. 1-1970. For ease of administration all Bell Canada territory is assumed to be within the Heavy Loading Area. This requires that values used for construction or maintenance provide specified minimum clearances at 0° Fahrenheit with an assumed 1/2" cylindrical ice coating around the outside diameter of the aerial plant.

1.04 Whenever two or more requirements apply to any one situation, the greater clearance or separation shall be used.

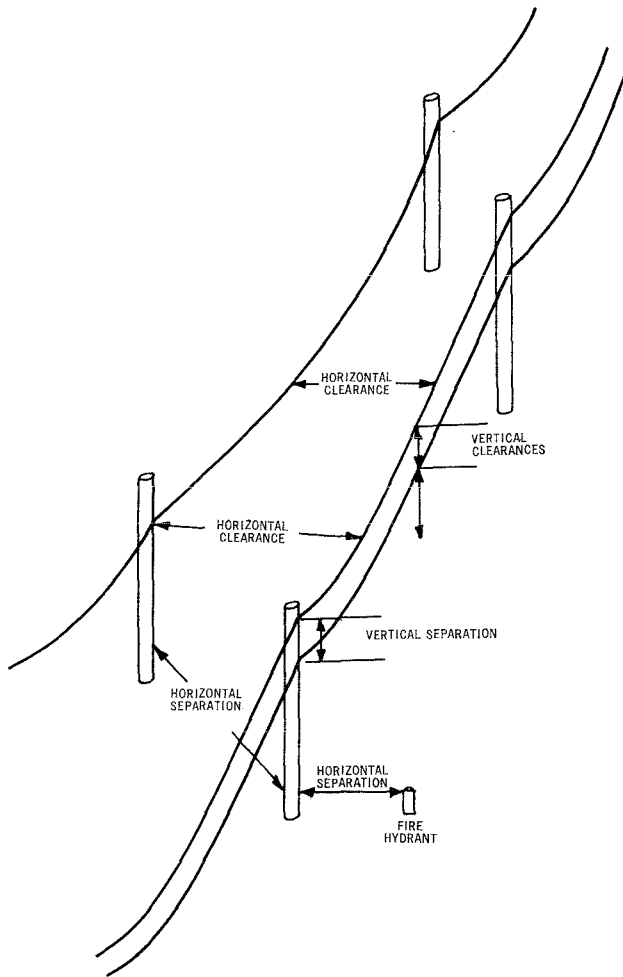


Fig. 1 — Illustration of Clearances and Separations

1.05 The tools to be used for measuring separations at the pole and clearances in the span, and the precautions to be taken when measuring in the vicinity of power plant are covered in 081-220-104CA.

1.06 This section has been reissued to incorporate all the clearance and separation re-

quirements for aerial plant (except joint use) in one section and to adjust values in accordance with C22.3 No. 1-1970. Coincident with this revision Sections 620-210-012CA (Clearances for Telephone Pole and Stub Poles) and 620-210-013CA, 620-210-014CA (Clearances for Telephone Cables, Guys, Line Wires and Drop Wires for Heavy and Medium Loading Areas) are cancelled.

**2. VERTICAL CLEARANCES FOR COMMUNICATION WIRES AND CABLES**

**Above Ground or Railway Tracks**

**2.01** Table A provides vertical clearances above ground and railway tracks for cables and wires. The values in Column I should be used for construction of new plant (including cases where new cable is placed on existing strand) except where other values are specified on the working plan. The values in Column II should be used for checking plant in place. The use of this column requires the calculation of the increase from the current sag to the maximum sag.

**2.02** The sag increment used in Column II is the difference between the sag at the time of measuring (i.e., at the appropriate temperature) and the sag at 0° Fahrenheit with an ice load. For suspension strand these values can be obtained from Sections 627-210-012CA, -013CA, -014CA, and -015CA using the cable weights specified in Table B (pair size and gauge available from Test Board or Engineering). For NEZ wire, sag values can be found in 624-700-902CA.

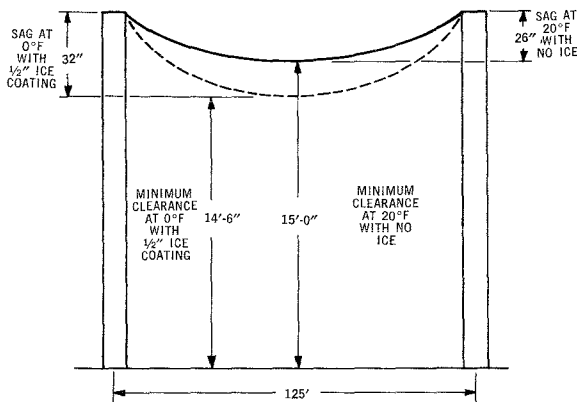
**Example No. 1**

Check existing road clearance to determine if it is adequate.

Temperature	20°F (no ice)
Cable Weight	4 lbs./ft.
Suspension Strand	10M
Span	125'
Measured Height Above Ground	17' - 0"

**627-210-013CA**

Cable Weight (Lbs./Ft.)	Temp. (°F)	Span 125 Ft.	
		Sag (in.)	Tens Lbs.
4.0	0	26	3925
	20	26	3800
	40	27	3675
	60	28	3575
	80	29	3450
	100	30	3350
*	32	4746	



Sag at 0°F with 1/2" ice	32" (from 627-210-013CA)
Sag at 20°F with no ice	26" (from 627-210-013CA)
Sag increment	6"
Minimum clearance 0°F with 1/2" ice	14'-6" (Table A Column II)
Minimum clearance at 20°F (no ice)	15'-0"

Therefore measured height of 17'-0" is adequate.

**TABLE A — VERTICAL CLEARANCE ABOVE GROUND OR RAILS  
FOR COMMUNICATION WIRES AND CABLES**

Location of Cable or Wire  (See Fig. 2 for examples)	Type of Plant	Maximum Span Length	Minimum Clearance	
			Constructing New Plant (Including Placing New Cable on Existing Strand) (Column I)	Checking Plant In Place (Column II)
1. (a) Over land likely to be travelled by road vehicles including highways, streets, lanes, alleys and driveways (other than to residences or residence garages).  (b) Over the right-of-way of underground pipelines.  (c) Alongside and within the limits of the right-of-way (fence line, property line, etc.) of streets and highways in densely populated areas.  (d) Over or alongside farm land likely to be travelled by road vehicles.	Cable on Suspension Strand	300'	18'-0"	14'-6" + Sag Increment (Para. 2.02)
	NEZ Rural Wire	150'	18'-0"	
		200'	19'-0"	
	NE Drop	100'	18'-0"	18'-0"
	X-Multiple Drop Wire	150'	18'-0"	
C & D Urban C, D & E Rural Open Wire				18'-0" (Para. 2.04)
2. (a) Over driveways to residences or residence garages.  (b) Over farm lands unlikely to be travelled by high farm vehicles e.g., steep slopes, sidehills, rocky ledges, etc., but excluding areas such as swamps that may be crossed by road vehicles in winter.	Cable on Suspension Strand	300'	15'-0"	12'-0" + Sag Increment (Para. 2.02)
	NEZ Rural Wire	150'	15'-0"	
		200'	16'-6"	
	NE Drop Wire	100'	15'-0"	15'-0"
		125'	16'-0"	
		175'	17'-0"	
	X-Multiple Drop Wire	150'	15'-0"	
	C & D Urban, C, D & E Rural, Open Wire			

TABLE A - (CONT'D)

Location of Cable or Wire (See Fig. 2 for examples)	Type of Plant	Maximum Span Length	Minimum Clearance	
			Constructing New Plant (Including Placing New Cable on Existing Strand) (Column I)	Checking Plant In Place (Column II)
3. Alongside roads and highways in areas unlikely to be travelled by road vehicles (with no plant overhanging the travelled portion of the road or highway) and including a 5 foot strip beyond the edge of the right-of-way (fence line, property line, etc.)	Cable on Suspension Strand	300'	14'-0"	10'-0" + Sag Increment (Para. 2.02)
	NEZ Rural Wire	175'	14'-0"	
		200'	14'-6"	
	NE Drop Wire	100'	14'-0"	14'-0"
		175'	15'-0"	
	X Multiple Drop Wire	150'	14'-0"	
C & D Urban C, D & E Rural, Open Wire				14'-0" (Para. 2.04)
4. Over walkways or ground normally accessible to pedestrians only.	Cable on Suspension Strand	300'	12'-0"	8'-0" + Sag Increment (Para. 2.02)
	NEZ Rural Wire	175'	12'-0"	
		200'	12'-6"	
	NE Drop Wire	100'	12'-0"	12'-0"
		175'	13'-0"	
	X Multiple Drop Wire	150'	12'-0"	
C & D Urban C, D & E Rural, Open Wire				12'-0" (Para. 2.04)

Table A Cont'd Next Page

TABLE A (CONT'D)

Location of Cable or Wire (See Fig. 2 for examples)	Type of Plant	Maximum Span Length	Minimum Clearance	
			Constructing New Plant (Including Placing New Cable on Existing Strand) (Column I)	Checking Plant In Place (Column II)
5. Above the highest rail at railway crossings (Figure 3).	Cable on Suspension Strand	300'	28'-6"	25'-0" + Sag Increment (Para. 2.02)
	NE Drop	100'	28'-6"	28'-6"
	X Multiple Drop Wire	150'	28'-6"	
	C & D Urban, C, D & E Rural, Open Wire	X	X	28'-6" (Para. 2.04)

TABLE B  
CABLE WEIGHTS FOR CHECKING SAGS OF CABLES IN PLACE<sup>(3)</sup>

Gauge of Cable Pairs	CABLE WEIGHTS (LBS/FT) <sup>(1)</sup> Pic, Pulp and Paper Insulated Conductors (All Pairs in Same Sheath) <sup>(2)</sup>					
	Up to 100 Prs	101 to 400 Prs	401 to 600 Prs	601 to 900 Prs	901 to 1200 Prs	1201 to 1800 Prs
26	1	2	2	3	3	4
24	1	2	2	3	4	6
22	1	3	4	5	6	—
19	2	4	6	—	—	—

*Note 1:* Add 1 lb/ft for up to 3 coaxial cables on same strand.

*Note 2:* If there is more than one cable on the same strand determine weight of each cable separately and add their weights together for sag calculations.

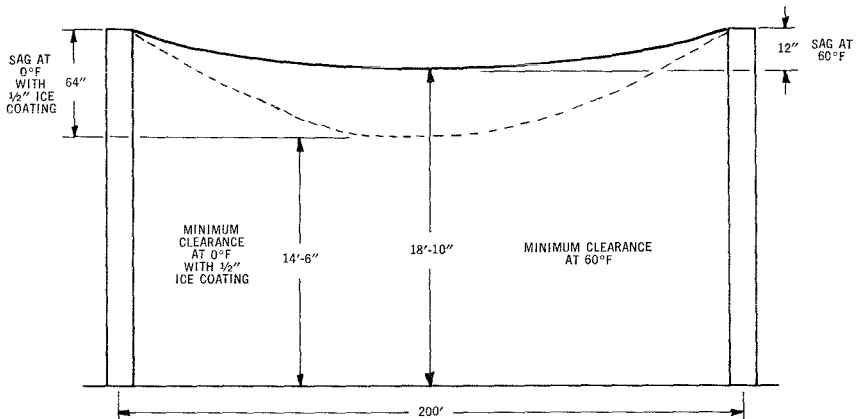
*Note 3:* Not to be used for constructing new cables (Construction values can be found in 626-200-103CA, etc.).

**Example No. 2**

Check existing road clearance to determine if it is adequate.

Temperature 60°F  
 NEZ rural wire  
 Span 200 feet  
 Measured height above ground 18 feet

624-700-902CA							
Span Length (Feet)	Temperature — Degrees Fahrenheit						
	100°	80°	60°	40°	20°	0°	*
	Sag (inches)						
200	14½	13	12	11	10	9½	64



Sag at 0°F with ½" ice 64" (from 624-700-902CA)  
 Sag at 60°F 12" (from 624-700-902CA)  
 Sag increment 52" or 4'-4"  
 Minimum clearance at 0°F ½" ice 14'-6" (Table A Column II)  
 Minimum clearance at 60°F 18'-10"

Therefore measured height of 18 feet is inadequate. Raise wire to construction clearance of 19'-0" (Table A Column I)



**SECTION 620-210-011CA**

**2.03** Table A restricts span lengths for NEZ wire and X-Multiple Drop Wires to values that will not produce a permanent stretch in the wire under ice load. This ensures that minimum clearances will be maintained through repeated ice loading cycles. NE Drop Wire has been similarly restricted in locations accessible to fast moving motor vehicles and trains. In other locations, lengths of up to 175 feet may be used provided that an additional foot is added to the recommended clearance value at the time of construction to compensate for the permanent elongation that will occur following an ice load.

**2.04** As C and D urban, C, D and E rural, and open wire have been destandardized for new construction, there are no values shown in Table A Column I and no maximum spans given. Values shown in Column II are for use in checking plant in place, subject to the following:

(a) For C Rural Wire spans in excess of 150 feet, increase the clearances of Column II as follows:

<b>Span Length (Feet)</b>	<b>Required Clearance Increase</b>
151-175	1 foot
176-200	2 feet
201-225	3 feet
226-250	4 feet

(b) For C and D urban and D and E rural wire in spans of 226 to 250 feet, increase the clearance of Column II by one foot.

(c) For open wire, clearances in excess of those shown in Column II are desirable, especially for road crossing spans in excess of 100 feet.

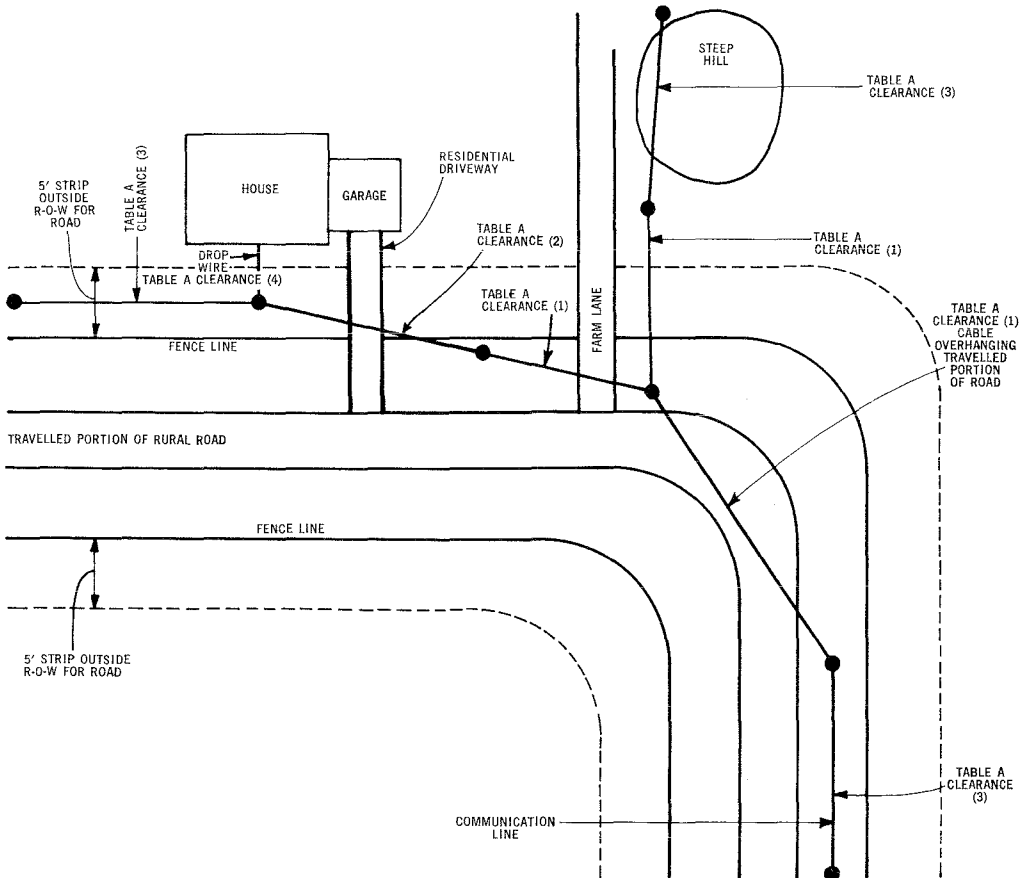


Fig. 2 — Illustration of use of Vertical Clearances of Table A (Not to Scale)

**From Foreign Power or Communication Plant (Non Joint Use Construction)**

**2.05** Where Bell plant (except drop wires Para. 2.06) passes under or over foreign plant without attaching to a common crossing pole, or runs parallel to foreign plant carried on a separate pole line, Engineering will specify the appropriate clearance as its value is dependent on the sag of the foreign conductors under specified thermal or ice loading conditions and the power voltage. Such cases include the following:

- (a) A power line passing over Bell plant. (Bell plant must not pass over a power line.)

- (b) A foreign communication line passing over or under Bell plant.
- (c) A power line running parallel to Bell plant on a separate pole line.

**2.06** Minimum vertical clearances between communication drops and power conductors are specified in 620-220-011CA.

**From Swimming Pools**

**2.07** Communication wires or cables must not be placed above a swimming pool nor above,

**SECTION 620-210-011CA**

or in the immediate vicinity of any associated diving structure.

**Above Buildings, Signs, Etc.**

**2.08** The minimum vertical clearance of communication wires or cables from buildings, signs, etc., under the sag conditions produced by a 1/2 inch ice coating on these wires or cables is as follows:

- Roofs that can be readily walked upon . . . 3 feet
- Other roofs . . . . . 3 inches
- Signs, etc. . . . . 3 inches

**3. HORIZONTAL CLEARANCES AND SEPARATIONS FOR COMMUNICATION WIRES, CABLES, POLES AND STUBS**

**From Rails**

**3.01** Table C specifies the minimum horizontal clearance or separation required between

the vertical projection of the inside edge of the nearest rail and:

- (a) the closest communication wire or cable paralleling the tracks (unless it exceeds the vertical clearance value shown in Table A) or
- (b) a pole, stub pole or guy associated with either a crossing or parallel line.

**3.02** At loading sidings sufficient space must be left for a driveway in accordance with the stated needs of the railway.

**3.03** Communication plant must not obstruct the view of signals, signs and similar equipment.

**(I) TABLE C — MINIMUM HORIZONTAL CLEARANCE OR SEPARATION BETWEEN RAILWAY TRACKS AND COMMUNICATION PLANT FOR SPANS NOT EXCEEDING 175 FEET (WIRES AND CABLES AT REST)<sup>(3)</sup>**

Clearance or Separation Between Communication Wires, Cables, Poles, Stub Poles, or Guys and the Inside Edge of the Vertical Projection of the Nearest Rail For (Fig. 3):	Main Tracks	Sidings
Straight Tracks	10'-0" <sup>(2)</sup>	8'-0" <sup>(2)</sup>
Curved Tracks	12'-6" <sup>(2)</sup>	10'-6" <sup>(2)</sup>

*Note 1:* Not required for wires or cables that meet the vertical clearance requirements of Table A.

*Note 2:* For NEZ wire use 30 feet.

*Note 3:* Limit NE drop wire spans to 100 feet unless horizontal clearance to tracks is 30 feet or more.

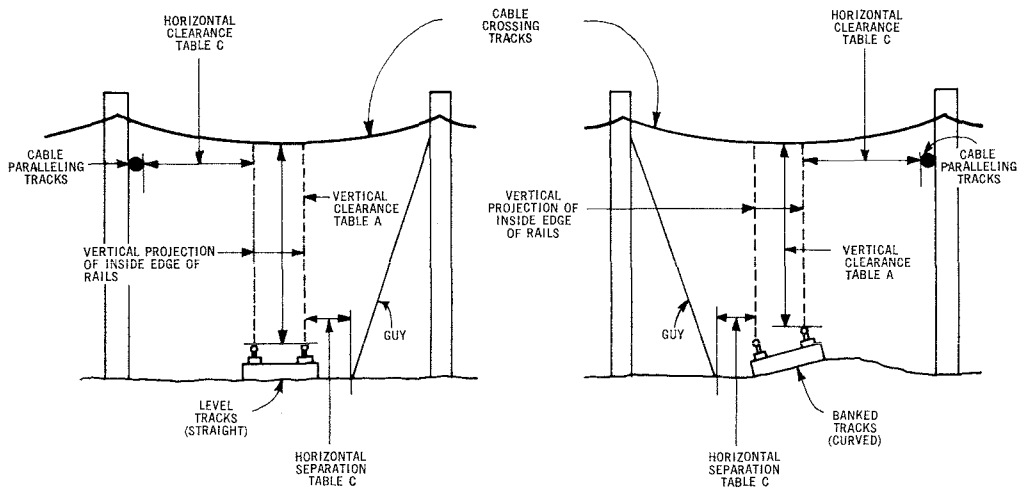


Fig. 3 — Clearance and Separation Between Communication Plant and Railway Tracks

#### From Power Wires Carried on a Separate Pole Line

**3.04** Engineering will specify the appropriate horizontal clearance between a Bell pole line and a paralleling power line when joint use construction is not present.

#### Separation of Poles and Stubs from Fire Hydrants and Curbs

**3.05** The minimum horizontal separation between a pole or stub pole (including any attachments 8 feet or less above ground level) and a fire hydrant is 3 feet.

**3.06** Poles or stub poles including any attachments projecting from them within 14'-6" from the ground shall be set back a minimum of 6 inches from the vertical edge of a curb (or its vertical projection), measured away from the travelled portion of the road.

#### Wires and Cables Passing By (But Not Attached To) Buildings, Signs, Billboards, Lamp and Traffic Signs, Standards and Antennas

**3.07** Wires or cables whether at rest or swinging under maximum ice and wind loading conditions must not interfere with the normal use

of balconies, doors, fire escapes windows, permanent ladders, catwalks, etc.

**3.08** Where buildings exceed three stories (or 50 feet) in height and ladders are used by the local fire department, a clear vertical space at least 6 feet wide is required adjacent to the building or beginning within 8 feet of it for the purpose of raising ladders. This space may be either parallel to or at right angles to the adjacent building wall and must be of sufficient length to accommodate the longest ladders used by the local fire department.

**3.09** The minimum horizontal clearance to buildings, signs, etc., shall be sufficient to prevent the conductors from hitting or rubbing against these objects under maximum horizontal swing conditions with ice and wind loading. Allowance must also be made for the swing of the object (e.g., a sign) where applicable.

## 4. CLEARANCES FOR GUYS

### Communication Guys

**4.01** A minimum clearance of 3 inches is required between communication guys and

## SECTION 620-210-011CA

(a) communication conductors attached to the same pole; or (b) span wires supporting luminaires or similar equipment (span wires attached to the same pole may require strain insulators — 620-215-011CA).

**4.02** The minimum clearance in any direction between a communication guy and a foreign power or communication guy not associated with the same pole line is 24 inches.

**4.03** Guys passing over or in the vicinity of railway tracks or over land used for vehicular or pedestrian traffic require a *minimum* vertical clearance equivalent to the values for suspension strand in Table A Column II assuming a sag increment of one foot (e.g., 15'-6" over a roadway), or the *minimum* horizontal clearance of Table C.

**4.04** The minimum horizontal separation between a guy and a fire hydrant is 3 feet unless the guy is more than 6 feet above the top of the hydrant.

**4.05** Guys and guy rods shall be set back a minimum of 6 inches from the edge of the curb, measured away from the travelled portion of the road.

**4.06** Guys in locations where they pose a hazard to motor vehicles, pedestrians, skiers, snow vehicles, etc., must be equipped with substantial and conspicuous guards.

**4.07** On joint use poles, communication guys shall be attached below the neutral space (620-215-011CA).

**4.08** Clearances from swimming pools, buildings, signs, billboards, lamp and traffic signs, standards and antennas shall be the same as those required for wires and cables in Paras. 2.07, 2.08, 3.07 and 3.08.

### **Power Guys Attached to Poles Carrying Communication Wires and Cables**

**4.09** On joint use poles, power guys shall be attached at least 30 inches above or below the communication space.

**4.10** If, on a joint use pole, a power guy is attached above current carrying power plant operating at 300 volts or more to ground and it comes within 40 inches of communication conductors or the communication space on the pole (excluding communication guys) it must be effectively grounded. If this cannot be done the portion having the inadequate clearance must be insulated with guy insulators.

**4.11** Power guys attached to a joint use pole and meeting the requirements of Para. 4.10 require the following clearances from communication plant:

- guys parallel to the direction of the line  
- 3 inches
- transverse guys  
- 6 inches

**4.12** Guys from remote power poles may be attached to poles carrying communication plant if they meet the same requirements as those for joint use poles (Paras. 4.09 and 4.10).

## JOINT USE CLEARANCES IN THE SPAN AND SEPARATIONS AT THE POLE

	CONTENTS	PAGE
1.	GENERAL . . . . .	555
2.	VERTICAL SEPARATIONS AT THE POLE . . . . .	555
3.	MINIMUM VERTICAL CLEARANCE IN THE SPAN BETWEEN POWER AND COMMUNICATION CONDUCTORS . . . . .	557
4.	VERTICAL RUNS OF POWER AND COMMUNICATION CONDUCTORS AT THE POLE . . . . .	558
5.	CLIMBING SPACE . . . . .	559

### 1. GENERAL

1.01 This section contains the MINIMUM clearance and separation requirement applying generally to the construction and maintenance of joint plant.

1.02 This section is reissued to clarify the interpretation of the requirements of CSA Standard C22.3 No. 1-1970.

1.03 Communication plant owned by other parties must be treated as power plant unless it is so constructed throughout its length as to meet the separation from power plant required for Bell Canada plant.

1.04 Where two or more clearance requirements apply to any situation, the requirement for the greater clearance shall be used.

1.05 The minimum clearances specified in Tables A and B should be increased if additional space is required for future construction or maintenance operations.

1.06 The clearances specified in this section apply to the normal level arrangement at the pole, i.e., from the top down:

- (a) Supply (higher voltages)
- (b) Supply (lower voltages)
- (c) Communication
- (d) Trolley span wires (See Para. 2.04)

The inverted level arrangement, i.e., supply conductors below communication conductors, is not acceptable to Bell Canada and should not be used. Trolley *feeder* wires must therefore be placed above communication conductors.

1.07 Vertical separations at the pole between current carrying parts of supply and communication plant respectively serve both:

- (a) To provide safe clearance from the line-man's body as follows:
  - (1) *Supply Lineman*: from the feet to communication plant when supply conductors are waist high.
  - (2) *Communication Lineman*: from the head to supply plant when communication conductors are immediately below shoulder level.
- (b) To minimize possible contact between usual types of supply and communication wires or cables in the span when ice remains on the supply conductors while off the communication conductors.

1.08 Instructions for measuring clearances in the span and separations at the poles are given in Section 081-220-104.

### 2. VERTICAL SEPARATIONS AT THE POLE

2.01 The minimum vertical separations at the pole for the normal level arrangement are

**SECTION 620-215-011CA**

given in Table A. Increased separations, however, may be needed to meet the clearance requirements in the span. (See Part 3).

**2.02** Joint use drop wires (i.e. an assembly of power service wire and telephone service wire manufactured as a unit), although listed separately in Table A, are treated as live current carrying supply plant in each joint use drop wire span. Special requirements for terminating the communication portion of such drops are given in Section 462-800-900.

**2.03** The minimum lateral telephone drop wire separation specified in the footnote to Table A, should not be used where greater separation is readily available.

**2.04** Span wires are wires or strand between two structures, the main purpose of which is to supply a mechanical support for trolley conductors, luminaires or similar equipment. Luminaire span wires must be provided with insulation suitable for the voltage and type of service concerned. Both luminaire and trolley span wires require a strain insulator not less than 6 feet from the pole.

**2.05** Luminaires operating over 300 volts to ground must be effectively grounded if located below communication plant.

**2.06** Switch handles must have at least 4 inches separation from communication plant. The metal frames and operating rods shall be effectively grounded.

**TABLE A**

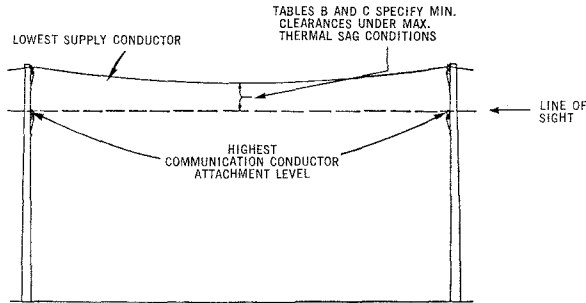
Minimum Vertical Separations at the Pole			
Minimum Separation Between Communication Wire, Cable, Strand, Guy, and Associated Hardware and:	Voltage to Ground of Supply Conductors		
	0 to 750 inches	Over 750 to 22,000 inches	Over 22,000 inches
Live or current carrying power plant (including neutrals, fuses, lightning arresters, disconnect switches, etc.)	40*	40	60 + (0.4 per 1000 volts over 50,000 volts)
Non-energized supply plant including cross-arm braces, transformer cases, through bolts etc., but excluding luminaire span wires, brackets (see below) and switch handles (Para. 2.06)			60 + (0.4 per 1000 volts over 50,000 volts)
UNGROUNDED --- --- ---	40*	40	
EFFECTIVELY GROUNDED --- --- ---	30*	30	40 + (0.4 per 1000V over 50,000V)
Trolley span wires or brackets (Paras. 1.06, 2.04)	12	Not Applicable	Not Applicable
Span wires and brackets for luminaires and traffic lights (Para. 2.04, 2.05)			Not Applicable
UNGROUNDED --- --- ---	12	40	
EFFECTIVELY GROUNDED --- --- ---	4	4	Not Applicable
Point of attachment of joint use drop wire (Para. 2.02)	40*	Not Applicable	Not Applicable
Communication power supply connected to the power service by an effectively grounded continuous metal sheathed cable or conduit.	0	Not Applicable	Not Applicable
Point of attachment of power guy	See Section 620-210-011		

\* A lesser value (minimum 24") may be used for communication drop wires if no other communication plant is attached to the pole.

**3. MINIMUM VERTICAL CLEARANCE IN THE SPAN BETWEEN POWER AND COMMUNICATION CONDUCTORS**

**3.01** The clearance between the lowest power conductor and the line of sight between the

point of support of the highest communication conductor not the actual clearance between these two conductors is used in determining the permissible clearance in the span. (See Fig. 1)



**Fig. 1 — Measurement of Clearance in the Span**

**3.02** The clearances specified in Tables B and C are those applying under the maximum thermal sag condition for the power conductor i.e., the condition under which the power conductor reaches its highest operating temperature. Since power wires are not usually placed under these conditions, an appropriate increase in the values shown in Tables B and C must be provided by the Power Company at the time of placing.

shown in Tables B and C may have to be obtained from the Power Company. In most cases however, the Power Company will sag their conductors to accommodate the communication conductor at the top of the communication space on the pole, in which case the requirements of Tables B and C will apply automatically.

**3.03** If the communication conductor is constructed after the power wires have been placed, the approximate increase in the clearances

**3.04** Clearance between power guys and communication conductors in the span are specified in Section 620-210-011.

**TABLE B**

<b>Minimum vertical clearances in span between supply and communication conductors under maximum thermal sag in supply conductor.</b>	
<b>Voltage to Ground of Supply Conductor</b>	<b>Clearance of Supply Conductor Above Line-of-Sight (See Fig. 1) of Points of Support of Highest Communication Wire or Cable</b>
0 to 750 volts with Thermoplastic Weatherproof Covering	0 inch
0 to 750 volts — other covering or bare	3 inches
over 750 volts to 15,000 volts	12 inches
over 15,000 volts to 22,000 volts	15 inches
over 22,000 volts to 250,000 volts	15 inches plus 0.4" per 1000 volts in excess of 22,000 volts.



TABLE C

Minimum vertical clearances in span between communication conductor and multigrounded neutral* conductor located 12" or more below supply conductor not exceeding 22,000 volts (in all other cases treat the neutral as a supply conductor and use Table B.)	
Span Less than 150'	Use clearances specified in Table B
Span 150' to 250'	Minimum separation at the structure shall be so adjusted that the neutral will not come below the line of sight of points of support of the highest communication conductor
Span over 250'	Multigrounded neutral can sag below line of sight of points of support of the highest communication conductor but not lower than 12 in. above communication conductor under conditions of: <ul style="list-style-type: none"> <li>(i) Maximum thermal sag in power circuit (Para. 3.02)</li> <li>(ii) Initial sag at 120F for communication circuit</li> </ul>

\* Neutral conductor must be effectively grounded

#### 4. VERTICAL RUNS OF POWER AND COMMUNICATION CONDUCTORS AT THE POLE

**4.01** Vertical runs attached to the surface of the pole shall be separated from span or guy wires by at least 2 inches (See Fig. 2). Vertical runs enclosed in a moulding of adequate electrical insulating and mechanical properties

do not require separation other than that provided by the moulding, but the guy or span wire must not abrade the moulding.

**4.02** Electrical and mechanical protection for vertical runs attached to the surface of the pole is illustrated in Fig. 3 (normal level arrangement):

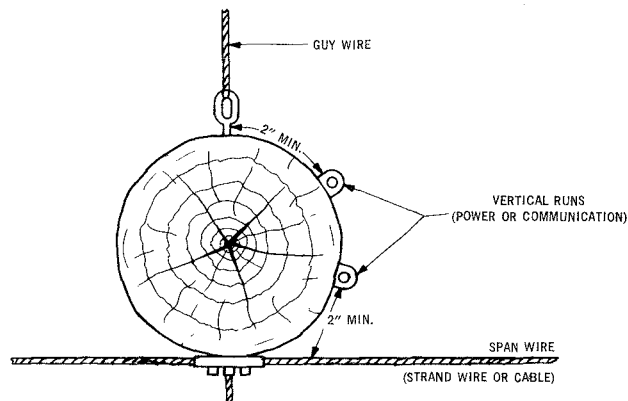


Fig. 2 — Minimum Separation Between Vertical Runs on Surface of Pole and Other Pole Attachments

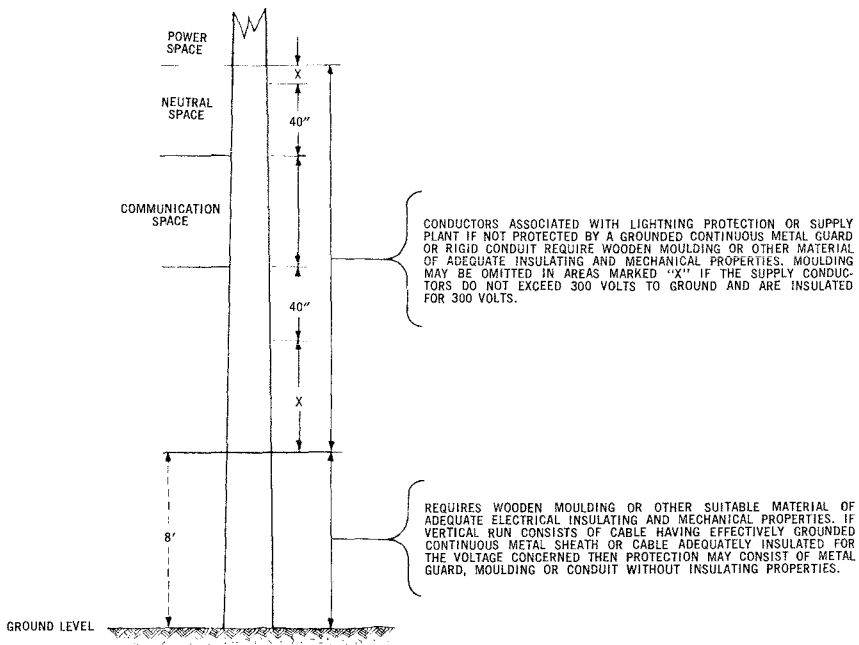


Fig. 3 — Vertical Runs on Poles

**4.03** Vertical runs not attached to the surface of the pole such as lamp leads running directly from a supply crossarm through or within 40 inches vertically from the communication line plant shall be held taut at least 40 inches from the surface of the pole unless insulated. In passing through communication plant, these conductors shall have a minimum clearance of 12 inches beyond the end of the communication crossarm, 6 inches from communication drop

wire and 20 inches from communication cable unless provided with insulation for the voltage and type of service concerned. (Fig. 4).

#### 5. CLIMBING SPACE

**5.01** A climbing space shall be provided past the communication conductors, cables, crossarms or attachments in the communication space, and extending 40 inches above and below the limiting conductors as follows:

SECTION 620-215-011CA

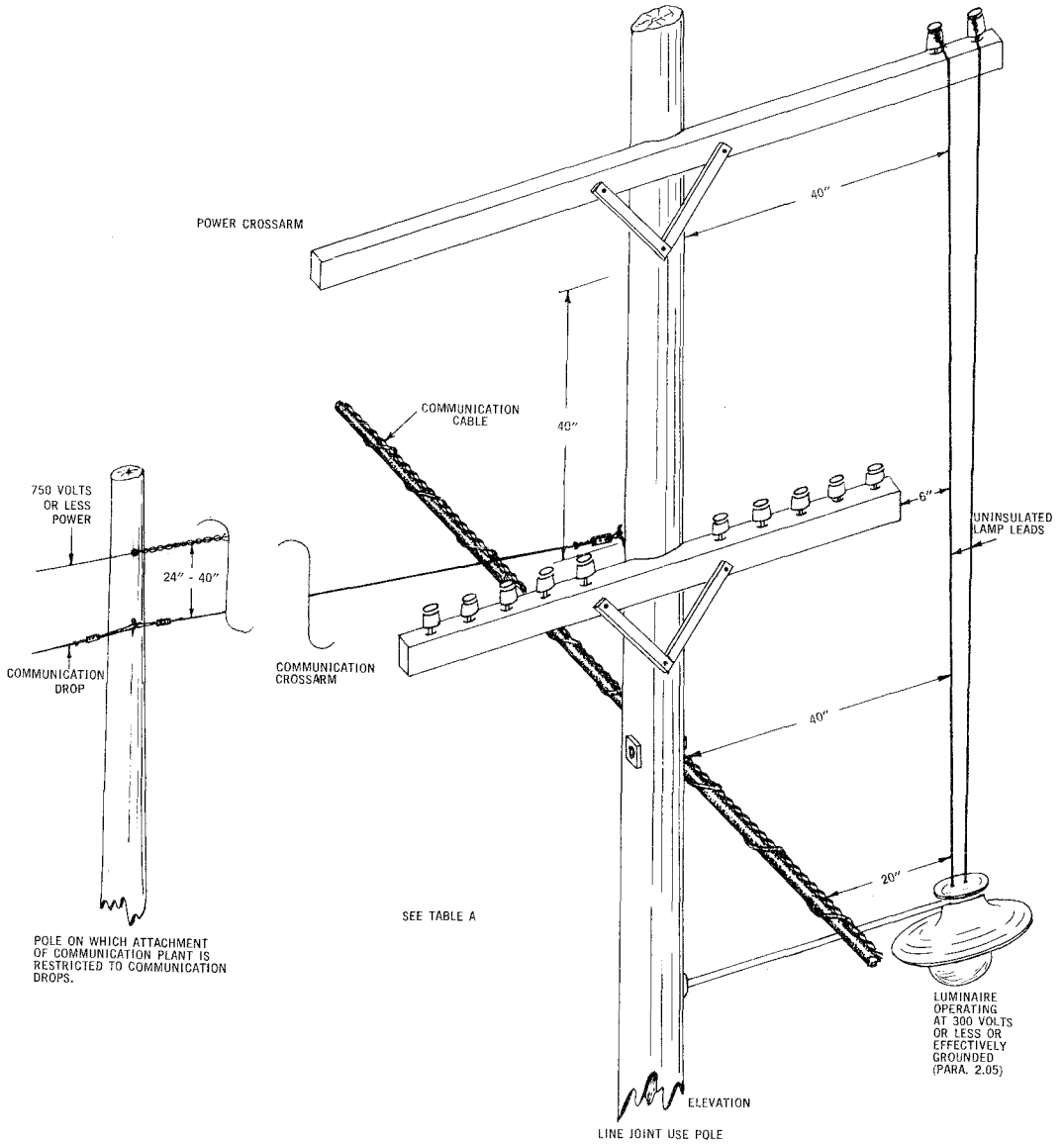


Fig. 4 - Minimum Clearances At Poles

(a) 30 inches by 30 inches. This must be so arranged as to permit the hoisting of transformers, crossarms etc., to the upper position of the structure. (Fig. 5).

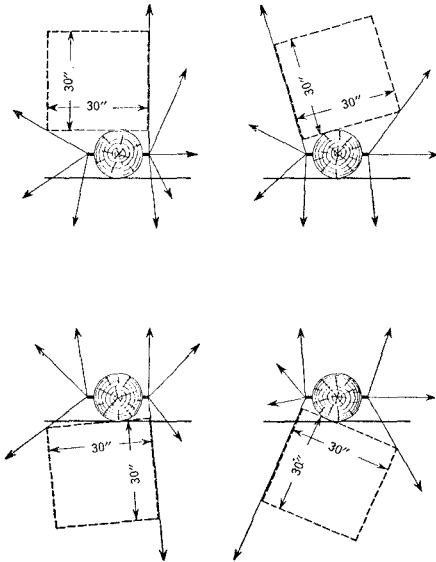


Fig. 5 — Examples of 30x30 Climbing Space

(b) 16 inches by 30 inches where supply service conductors only are attached to the top of a common crossing pole. (Fig. 6).

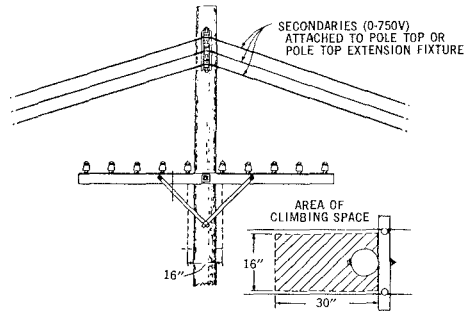


Fig. 6 — Climbing Space at Crossing Pole

5.02 No attachment on the structure shall encroach into the climbing space except as follows:

- (a) Pole steps at the side of the climbing space.
- (b) Crossarms or communication longitudinal runs along the side of the climbing space.
- (c) Vertical runs in the climbing space provided they are suitably protected and do not interfere with the use of pole steps or lineman's climbers.



**GENERAL**  
**SEPARATIONS FOR DROP AND BLOCK WIRING**

CONTENTS	PAGE
1. GENERAL . . . . .	563
2. MINIMUM SEPARATIONS ON OUTSIDE OF BUILDINGS . . . . .	563
3. MINIMUM SEPARATIONS FOR DROP WIRE SPANS TO BUILDINGS . . . . .	564
4. RADIO AND TELEVISION ANTENNAE . . . . .	564
5. RADIO AND TELEVISION ANTENNAE LEAD-IN CONDUCTORS . . . . .	564

**1. GENERAL**

**1.01** This section outlines the Company's policy with respect to antenna attachments to Telephone Company poles or other fixtures and clearances between telephone conductors and antennae lead-in conductors. It is reissued to revise reference section number.

**1.02** Circuits associated with community TV Systems, other than those installed by the Telephone Company, should be treated as power circuits due to the possibility of improper clearance from power circuits or attachments.

**1.03** Where obtainable greater separations than those indicated herein are desirable from a maintenance standpoint.

**1.04** Minimum separations for buried wire, underground service cable located on the outside of buildings and for wiring extended outside of buildings are the same as those specified herein for drop and block wires.

**1.05** *Drop and block wires, buried wires and service cables shall not be placed in pipe, conduit or compartment containing electric light*

*or power wires or cables, nor in the same outlet box, junction box or similar fitting compartment unless separated from the electric light or power wires by a suitable partition, except where the power wires are terminated in an outlet box, junction box or compartment solely as power supply to signalling equipment or for connection to remote control equipment.*

**2. MINIMUM SEPARATIONS ON OUTSIDE OF BUILDINGS**

**2.01** Table 1 specifies (a) recommended minimum separations for drop or block wires that cross or parallel other conductors or metallic objects on the outside of buildings and (b) the type of supplemental protection to be placed at crossings where the minimum separations cannot be obtained.

**TABLE 1**  
**MINIMUM SEPARATIONS BETWEEN DROP, BLOCK AND TELEPHONE GROUND WIRES ON BUILDINGS TO TYPE OF PLANT INDICATED BELOW (Applies to crossings and to horizontal or vertical parallel runs)**

Type of Plant Involved (Including Associated Fixed Equipment and Wiring)	Minimum Separations	Protection Required if Minimum Separations cannot be Obtained
1. Electric Supply: Service Drops or Open Wiring not over 750 Volts Wires in Conduit or in Armored or Non Metallic Sheath Cable	4 in.	
	2 in.	
2. Radio and Television: Antenna Lead-in and Ground Wires	4 in.	
3. Signal Wires: Open Wires or Wires in Conduit or Cable	2 in.	
4. Communication Wires: Foreign Open Wires and Wires in Conduit or Cable Between Exposed and Unexposed Telephone Co. Wires	2 in.	P Wire Guard*
	2 in.	
5. Metallic Objects: Rain Spouts and Gutters Gratings etc.	2 in. —	

SECTION 620-220-011CA

TABLE 1 — (Con't'd)

Type of Plant Involved (Including Associated Fixed Equipment and Wiring)		Minimum Separations	Protection Required if Minimum Separations cannot be Obtained
6. Ground Wires:	Ground Wires (Except Radio, Television, Lightning Ground Wires, and Telephone Ground Wires)		
7. Lightning:	Lightning Wires and Rods	6 ft.	See Para. 2.02
8. Signs:	Neon Signs and Associated Wiring from Transformer	6 in.	P Wire Guard 12 in. Long*
	Telephone Ground Rods to other Ground Rods	6 ft.	No Alternative

\* Applies only to crossings. For parallel runs the indicated minimum separations must be obtained.

2.02 Separations of less than 6 feet between drop, block or telephone ground wires and lightning wires or rods are permissible under the following conditions. In no case shall the separation be less than 4 inches.

(a) Where telephone, power and lightning rod ground connections are made to a common grounding medium such as a cold water pipe.

(b) Where separate driven ground rods are used for telephone power and lightning rod installations, *and the ground rods are bonded together.*

3. MINIMUM SEPARATIONS FOR DROP WIRE SPANS TO BUILDINGS

3.01 Table 2 specifies the minimum separations that shall be obtained between drop wire in the span to a building and other conductors or metallic objects.

TABLE 2  
MINIMUM SEPARATIONS BETWEEN DROP WIRE SPAN TO BUILDINGS AND TYPE OF PLANT INDICATED BELOW

Type of Plant Involved Including Associated Fixed Equipment and Wiring		Drop Wire Span to Building Minimum Separation	
		Crossing	Parallel
1. Electric Supply:	Service Drops or Open Wiring not over 750 Volts	2 ft.	1 ft.
	Wires in Conduit or in Armored or Non Metallic Sheath Cable	4 in.	4 in.
2. Radio and Television:	Antenna Lead-in and Ground Wires	2 ft.	1 ft.
3. Signal Wires:	Open Wires	2 ft.	1 ft.
	Wires in Conduit or Cable	4 in.	4 in.

TABLE 2 — (Con't'd)

Type of Plant Involved Including Associated Fixed Equipment and Wiring		Drop Wire Span to Building Minimum Separation	
		Crossing	Parallel
4. Communication Wires:	Foreign Open Wires	2 ft.	1 ft.
	Foreign Wires in Conduit or Cable	4 in.	4 in.
5. Metallic Objects:	Rain Spouts, Gutters, etc.	4 in.	4 in.
6. Ground Wires:	Ground Wires (Except Radio, Television, and Lightning Ground Wires)	4 in.	4 in.
7. Lightning:	Lightning Wires and Rods (See Para. 2.02)	6 ft.	6 ft.
8. Signs:	Neon Signs and Assoc. Wiring from Transformer	1 ft.	1 ft.

4. RADIO AND TELEVISION ANTENNAE

4.01 No permits have been issued or shall be issued, to provide authority for the attachment of antennae to telephone company poles or other property due to hazards they present.

4.02 When an antenna is found attached to one of our poles, the owner shall be requested to remove it. Should he refuse to comply with the request, the craftsman shall prepare a copy of Form 732, "Report of Hazardous Plant Conditions", giving the location, describing the conditions, outlining discussions with the owner, etc., and shall forward the report to his supervisor. Additional sheets should be attached to the Form 732 when the space thereon is insufficient to cover a complete report.

4.03 Form 732 shall be processed as outlined in the Plant Administration Practices.

5. RADIO AND TELEVISION ANTENNAE LEAD-IN CONDUCTORS

5.01 Attention has been directed to the methods used\* in some locations by workmen installing foreign radio and television receiver antennae and lead-in conductors. It has been found that there were cases where the lead-in conductors were attached to Telephone Company drop wire supports and were also being placed in ring runs. Such installations do not conform to the clearance requirements outlined in this section. In some instances the lead-in conductors were not equipped with lightning protection devices.

**5.02** Foreign lead-in conductors from out-door antennae should be attached to buildings in such a manner as to provide clearance of at least 4 inches from telephone conductors. In connection with the omission of lightning arresters we are concerned in those situations where, because of the close proximity of the lead-in conductors and the telephone conductors, lightning discharges to the antenna may be carried into the building through the telephone wiring.

**5.03** Where a foreign television or radio antenna lead-in conductor crosses a telephone wire, a 6 inch piece of P Wire Guard shall be placed on the telephone wire, centered so that its ends are equidistant from the lead-in conductor as illustrated in Section 462-450-205CA.

**5.04** Sometimes it may be possible to disengage foreign lead-in conductors from Telephone Company attachments without causing interrup-

tions or creating unsatisfactory conditions pending proper correction by the customer. Where the Telephone Company has full jurisdiction over attachments, i.e., on telephone poles and fixtures, etc., the customer should be advised of such proposed rearrangements. In other cases, the customer's permission should be obtained before disengaging the conductor.

**5.05** In discussing rearrangements the employee may explain to the customer that the fastening of the television lead-in wire to telephone attachments is not in accordance with the safety practices adopted by the Telephone Company and under some circumstances might have a detrimental effect on the television signal.

**5.06** Where it is difficult to secure cooperation from the customer, or corrective action is not taken, the case shall be reported on Form 732 as outlined in Para. 2.02.





BURIED PLANT  
JOINING UNDERGROUND AND BURIED WIRE  
KIT ENCAPSULATION WIRE BURIED Z

CONTENTS	PAGE
1. GENERAL . . . . .	567
2. MATERIAL AND TOOLS . . . . .	567
3. PRECAUTIONS . . . . .	568
4. PREPARING WIRE ENDS . . . . .	568
Wire Service Z	
Wire Underground ND	
5. JOINING CONDUCTORS . . . . .	569
6. ENCAPSULATION OF CONDUCTORS . . . . .	569
7. SECTION REPLACEMENT . . . . .	570

1. GENERAL

1.01 This section describes the methods and materials used in joining Z Service and ND Underground Wires using the Kit Encapsulation Wire Buried Z. It also includes connecting of the outer armour wire at these locations which, to be fully effective as lightning protection, must be made electrically continuous. This method of joining is to be used on all types of buried wires.

1.02 This section replaces Sections 629-760-200, 629-760-206, 629-760-211, and 629-760-900.

1.03 The description of buried and underground wire can be found in Section 629-700-011CA.

1.04 Joining buried wires with the Z buried wire encapsulation kit employs the butt splice method. Once completed the joint may never be reentered.

1.05 Joining should follow as soon as practical after placing, but not before the wire has been tested and found free of faults.

1.06 In wet weather, joining of the wires should be done under a shelter or tent to keep surfaces of the wires dry.

1.07 The joint may be buried after completion, however the first six inches of backfill should have no rocks in it.

2. MATERIAL AND TOOLS

2.01 The following tools and materials are required for joining and encapsulating Z Service Wire or ND Underground Wire:

- (a) Kit Encapsulation Wire Buried - Z Used for encapsulating the connected conductors of the buried wire. See Fig. 1.
- (b) Connector Wire B Used for joining the conductor of the buried wire as outlined in Section 632-205-201.
- (c) Connector Bridging 22031 Used to make the armour of the buried wire electrically continuous through the joint.
- (d) Tape Vinyl 1 inch vinyl for wrapping the top of plastic bag containing the encapsulation compound.
- (e) Pliers Long Nose For general use in removing outer insulation of Z Service Wire only.
- (f) Slitter Wire Underground N. D. Used for removing the outer and conductor insulation from ND Underground Wire only.

- (g) Presser Connector B Used to connect the conductors of the buried wires.
- (h) Scissors Splicer's C Used for skinning the conductors of Z Service Wire and cutting plastic encapsulation bag.

POLYURETHANE BOOT USED TO CENTER JOINED CONDUCTORS IN THE ENCAPSULATION COMPOUND.

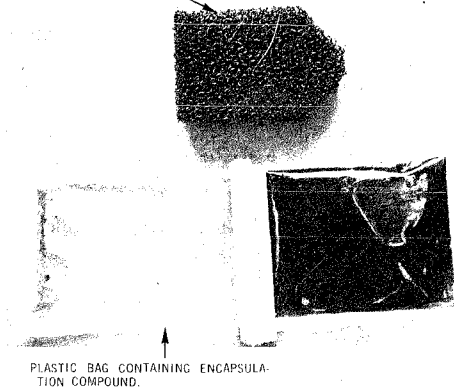


Fig. 1 - Contents of the Z Encapsulation Kit

**3. PRECAUTIONS**

3.01 Avoid prolonged or repeated contact with skin or breathing of vapor. Use only with adequate ventilation. In case of contact with eyes, flush with flowing water for at least 15 minutes and get medical attention.

3.02 In cold weather preheat the plugging compound to approximately 70° degrees before mixing. This may be accomplished by placing the compound near the truck heater or inside winter clothing.

**4. PREPARING WIRE ENDS**

4.01 In preparing the ends of the Conductors for joining, using the Kit Encapsulation Wire Buried Z, measurements will remain the same as for the Z Service Wire indicated herein.

4.02 The removal of the outer jacket of buried wires differ, as does the installation from the inner conductors and should be completed as indicated in this section.

**Wire Service Z**

4.03 In preparation for splicing the conductors, remove the outer black polyvinyl-chloride jacket as follows:

4.04 Using splicer's scissors make approximately a 1/2 inch slit in the end of the jacket to expose the white nylon slitting cord.

4.05 Grasp the slitting cord firmly between the jaws of the long nose pliers. Pull the cord with the long nose pliers and slit the jacket for approximately 5 inches from the end of the wire as shown in Fig. 2. Trim off the slit portion of the jacket using the splicer's scissors.

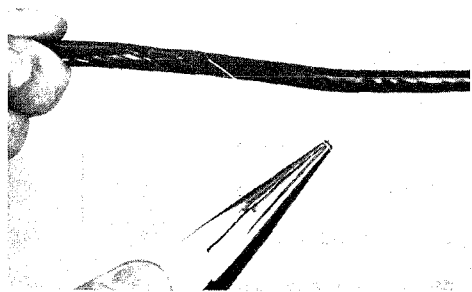


Fig. 2 - Removing Outer Jacket

4.06 Install a 22031 Bridging Connector over the exposed shield wire of the two Z Service Wires as close as practical to the outer black polyvinyl-chloride jacket as shown in Fig. 3. Hand tighten the nut of the bridging connector being careful not to damage the inner conductors.

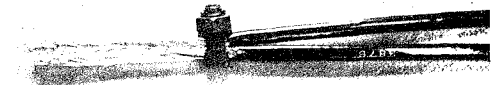


Fig. 3

4.07 Free the armour wires from the wire core and cut them off about 3/4 inch from the bridging connector. Fold the armour wires back over the bridging connector and tuck neatly in place.

4.08 Slit and remove the inner jacket to within a distance of about  $\frac{1}{2}$  inch from bridging connector using the procedures in 4.04 and 4.05.

4.09 Measure 2 inches from the bridging connector and cut off excess portion of conductors using the larger skinning notch of the C Splicer's Scissors, remove  $\frac{3}{4}$  inch of insulation from the end of each conductor.

The prepared wire as seen in Fig. 4 is ready for joining.

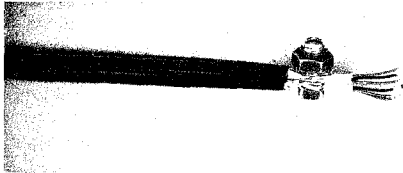
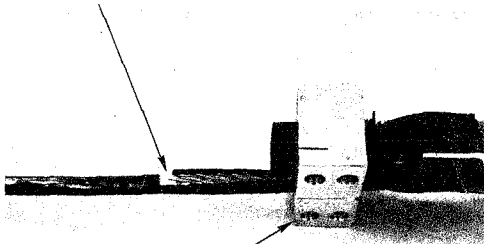


Fig. 4

#### Wire Underground ND

4.10 In preparation for splicing the conductors of the ND Underground Wire remove 5 inches of the outer PVC jacket as shown in Fig. 5.

1. RING PVC JACKET WITH SPLICER'S SCISSORS, CUT THROUGH TO ARMOUR, BUT DO NOT NICK OR CUT ARMOUR ITSELF.



2. USING LARGE GROOVE OF D UNDERGROUND WIRE SPLITTER MAKE LENGTHWISE CUT IN JACKET ON EACH SIDE OF WIRE.

Fig. 5

4.11 Place the 22031 Bridging Connector as indicated in Para. 4.06. Free the armour wire from the insulation, cut and fold them back over the bridging connector as indicated in Para. 4.07.

4.12 Using the smaller groove of the D Underground Wire Splitter split the insulation between the conductors to separate them as shown in Fig. 6.

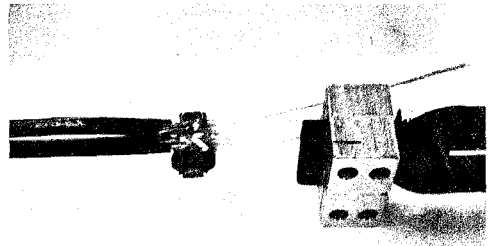


Fig. 6

4.13 As indicated in Para. 4.09 measure 2 inches from the bridging connector and cut off the excess portion of the conductors. Using the skinning notch on the D Underground Wire Slitter remove  $\frac{3}{4}$  inch of insulation from the end of each conductor.

4.14 The prepared ends of the ND Underground Wire is ready for joining.

#### 5. JOINING CONDUCTORS

5.01 Conductors of the buried wire are matched colour to colour and joined together with B Wire Connectors. Only the B Connector Presser shall be used. *The use of long nose pliers must be avoided.*

5.02 Once the conductors of the buried wire are joined together, gently fold them back over the bridging connector in preparation for encapsulation as shown in Fig. 7.

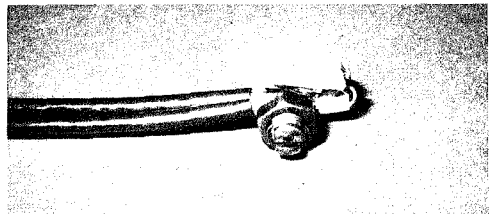


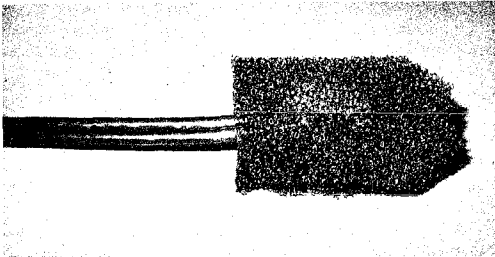
Fig. 7

#### 6. ENCAPSULATION OF CONDUCTORS

6.01 Remove the polyurethane boot and plastic bag containing the encapsulation compound from the cardboard container. If the temperature is below 60 degrees the compound should be placed in a warm place before mixing to shorten the set-up time.

## SECTION 629-760-201CA

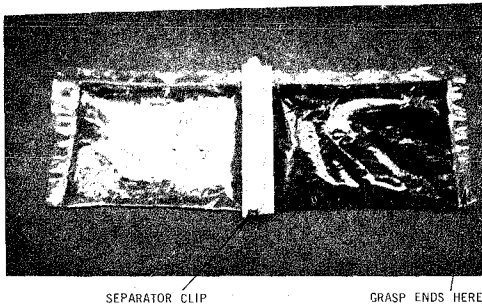
**6.02** Slide the polyurethane boot over the joined ends of the conductors as shown in Fig. 8. Care must be taken to ensure that the joined ends of the conductor do not protrude from the open end of the polyurethane boot.



**Fig. 8**

**6.03** The use of the polyurethane boot is required to ensure that the conductors of the joined wire will remain centered in the encapsulation compound during the set-up period.

**6.04** Remove the separator clip on the encapsulation compound by grasping the outer ends of the plastic bag and giving a quick firm snap. Fig. 9.



**Fig. 9 — Encapsulation Compound**

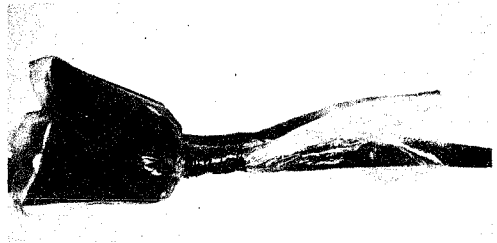
**6.05** Mix the resin thoroughly by laying the plastic bag on a flat surface and using the clip removed in 6.04. Scrape back and forth across the plastic bag for approximately one minute or until the bag begins to feel warm to the touch. When the compound is thoroughly mixed scrape all contents to one end.

**6.06** With splicer's scissors cut  $\frac{1}{2}$  inch off plastic encapsulation bag at the opposite end of contents.

**6.07** Gently slide the polyurethane boot containing the joined conductors into the encapsulation compound contained in the plastic bag. The polyurethane boot must be completely submerged beneath the encapsulation compound.

**6.08** The plastic bag containing the polyurethane boot, joined conductors and encapsulation compound must then be gently worked to remove any air bubbles that may be trapped or otherwise contained in the encapsulation solution.

**6.09** Once the air bubbles have been removed simply twist the remainder of the plastic bag around the encapsulated wires and tape tightly with vinyl tape. Fig. 10.



**Fig. 10 — Encapsulated Wires**

**6.10** The compound will begin to set within approximately 5 minutes. At this time the splice may be placed in the trench and covered with no additional protection.

## 7. SECTION REPLACEMENT

**7.01** No replacement of service wire should be completed with a smaller gauge than the existing facility. Any service wire required for repair, or to be used in a section replacement, must be of the same or larger gauge to avoid fusing in the repaired or replaced section.

## MD3209 AND MD3208 CABLE TERMINAL TERMINATING CONDUCTORS

	CONTENTS	PAGE
1.	GENERAL . . . . .	571
2.	TERMINAL BLOCKS . . . . .	571
3.	WIRE LEAD ASSEMBLY . . . . .	572
4.	PREPARING AND TERMINATING CONDUCTORS . . . . .	572
5.	REARRANGEMENT . . . . .	574

### 1. GENERAL

**1.01** This section describes the method of arranging plastic-insulated conductors for terminating in MD3209 and MD3208 Cable Terminals.

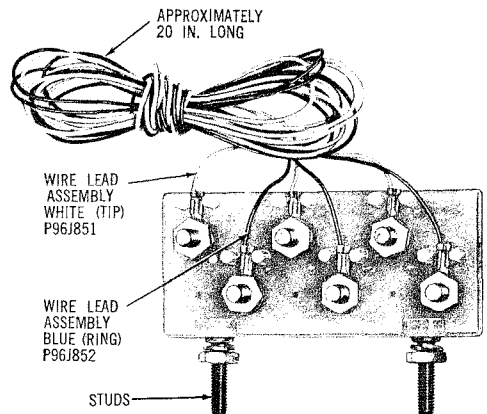
**1.02** This section is revised to include the Term Assignable Count (AC), which supersedes the Term Preferred Count. It also includes a notation (Fig. 5) indicating that the insulation on 19 ga. cable conductors must be removed before using ®U.G. Scotchlok Bridging Connectors.

**1.03** *The number of binding posts to be used within these terminals is restricted to a maximum of nine.*

**1.04** *All binding post terminations must be made within the Assignable Count (AC) of the terminal.* The AC of a terminal is specified on the work order which places the terminal, and may only be changed by a subsequent engineering work order.

### 2. TERMINAL BLOCKS

**2.01** The MD3209 and MD3208 Terminals are furnished with one QBN1C Terminal Block (Fig. 1) which supersedes the P18A782 Block. Each binding post of the QBN1C Block has a single 24-gauge Wire Tip Assembly attached. The top (tip) posts have white leads and the bottom (ring) posts have blue leads.



**Fig. 1 — QBN1C Terminal Block**

**2.02** After the first three binding post connections have been made, an additional QBN-1C Terminal Block may be placed in the second mounting position. A third block may be added if binding posts 7 to 9 are required.

## SECTION 631-240-206CA

**2.03** No more than three terminal blocks will be mounted in any MD3209(49A) or MD3208(49B) terminal.

**2.04** When mounting a terminal block, pierce the neoprene base visible in the mounting holes of the terminal and then work the studs of the block into the holes. Fasten securely with the nuts and lock washers provided.

### 3. WIRE LEAD ASSEMBLY

**3.01** Spare wire leads may be ordered separately to replace broken or defective leads. The ordering information is as follows:

Assembly Lead Wire P-96J851-(white)

Assembly Lead Wire P-96J852-(Blue)

The leads will be supplied in pkgs. of six.

**3.02** The conductors are 24-gauge PVC insulated wire equipped with a crimped terminal lug at one end (Fig. 3).

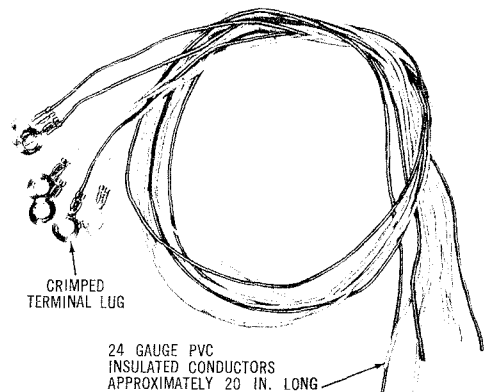
**3.03** The lugs of the crimped wire tips are equipped with tabs which make the lugs captive to the binding posts when installed. The wire tips are installed on the binding posts as follows:

- (1) Remove the binding post nut and washers.
- (2) Select the wire tip of the appropriate colour coding; white for tip, and blue for ring.
- (3) Place the wire tip lug on the binding post with the tabs projecting outward, away from the terminal block face plate.
- (4) Place the binding post washer over the wire tip lug and firmly tighten the binding post nut. The pressure of the washer squeezes the lug tabs inward to engage the binding post threads.

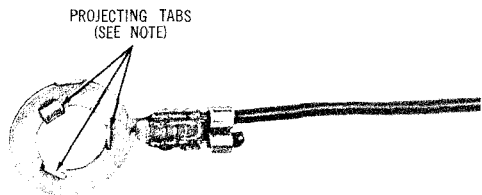
### 4. PREPARING AND TERMINATING CONDUCTORS

**4.01** The preferred method of joining the terminal block leads to the cable pairs assigned is with the SCOTCHLOK UG Bridging Connector. The use of UG Bridging Connectors eliminates

the need to cut the cable conductors, thereby reducing the possibility of open conductors beyond the terminal and also improving housekeeping in the terminal. Section 081-852-125 covers the de-



**Fig. 2 — Wire Lead Assembly**



**NOTE:**  
PLACE LUG ON BINDING POST WITH FLAT SURFACE TOWARD TERMINAL BLOCK FACEPLATE AND TABS PROJECTING OUTWARD

**Fig. 3 — Wire Lead Lug**

scription and use of SCOTCHLOK connectors. (Do not cut cable pairs).

**4.02** The conductors are prepared and terminated with SCOTCHLOK connectors as follows:

- (1) Separate the cable pairs assigned from the Assignable Count binder groups. Make certain that these pairs are not broken or damaged.

(2) Loop the terminal block leads from the binding posts through the wire retainer and back to the position where the bridge is to be made (Fig. 4).

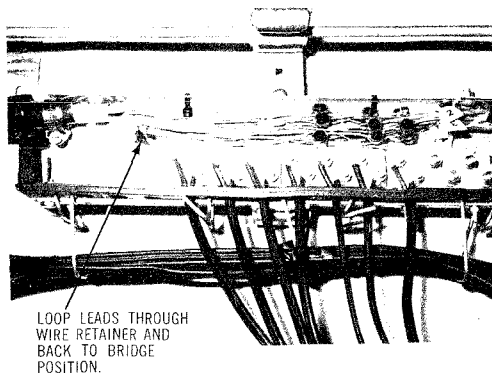
(3) Bridge the tip and ring terminal block leads to the tip and ring conductors of the assigned cable pair using UG SCOTCHLOK connectors and Z Pressing Pliers (Fig. 5). When pressing the connector make certain that the green button is pressed flush with the surface of the clear plastic connector housing.

(4) Stagger the positions of the UG Connectors. Fig. 6 shows the terminal block leads from binding position numbers 1 to 7 bridged to the cable conductors.

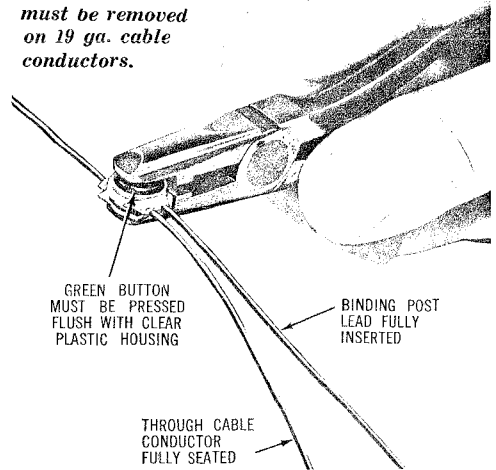
(5) As assignments are made, continue bridging the terminal block leads in the order of their binding post position numbers.

(6) Coil the unassigned binding post leads in the vacant space between the first terminal block and the left end of the terminal body.

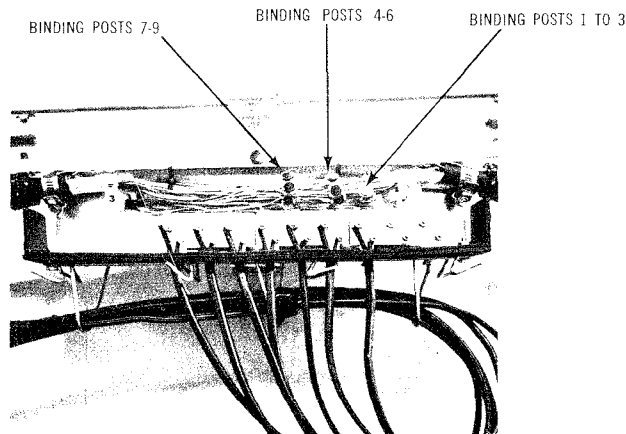
*Note: Insulation must be removed on 19 ga. cable conductors.*



**Fig. 4 — Bridging Binding Post Leads To Cable Conductors**



**Fig. 5 — Pressing UG SCOTCHLOK Connector with Z Pressing Pliers**



**Fig. 6 — Binding Post Positions 1 to 7 Bridged to Cable Conductors**



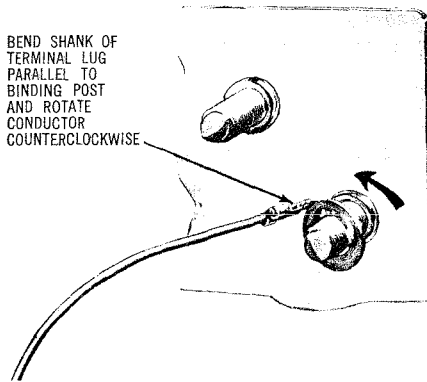


Fig. 7 — Removing Binding Post Leads

4.03 If replacement of wire leads become necessary, remove the old lead as illustrated in Fig. 7.

## 5. REARRANGEMENT

### Scotchlok UG Connectors

5.01 When binding post leads already bridged to a cable pair with UG Connectors are to be reassigned to another cable pair, proceed as follows:

- (1) Cut the binding post leads as near as possible to the connectors. Do not attempt to **remove the connectors from the cable pair conductors.**
- (2) Separate the newly assigned cable pairs from the Assignable Count binder group. Make certain these pairs are not damaged.
- (3) Reconnect the binding post leads to the newly assigned cable pair (Para. 4.02).

## QTC TYPE TERMINALS

### SERVICE WIRE & TERMINAL BLOCK INSTALLATION & TERMINATION

	CONTENTS	PAGE
1.	<b>GENERAL</b> . . . . .	575
2.	<b>SERVICE WIRE INSTALLATION</b> . . . . .	575
3.	<b>DISPOSITION OF UNTERMINATED PAIRS</b> . . . . .	577
	A) AT THE TERMINAL END	
	B) AT THE STATION END	
4.	<b>TERMINAL BLOCKS</b> . . . . .	577
	<b>NON-PROTECTED</b>	577
	<b>PROTECTED</b>	578
5.	<b>BRIDGING CONNECTORS</b> . . . . .	578
6.	<b>PREPARING AND CONNECTING TERMINAL BLOCK LEADS</b> . . . . .	579
7.	<b>PREPARING AND TERMINATING SERVICE WIRE CONDUCTORS</b> . . . . .	581
8.	<b>WIRE LEAD ASSEMBLY</b> . . . . .	582
9.	<b>REARRANGEMENTS</b> . . . . .	583

**1. GENERAL**

**1.01** This section is issued to describe service wire and terminal block installation in QTC type buried cable terminals, and the method of arranging and terminating the terminal block and service wire conductors.

**1.02** Although the method and figures illustrated in this section are oriented towards the termination of service wires, underground wire that is used for service and terminated in QTC type terminals should be completed in a similar manner.

**1.03** The number of pairs of binding posts that can be used in any QTC type terminal is restricted to a maximum of nine.

**1.04** No maintenance work or cable pair testing except by cable repair will be performed, or any connections made to pairs not in the assignable count, unless authorized by the Outside Plant Engineering.

**1.05** The placing of the terminals and the cable entrance into these terminals will be found in the appropriate section of the 631 series of Bell Canada Practices.

**2. SERVICE WIRE INSTALLATION**

**2.01** The installation of the service wire into the QTC type terminals will require the excavation of a small entrance pit at the base of the terminal. This pit *must* be hand dug and extreme caution must be used to avoid damage to the existing cable or service wire during the digging operations.

**2.02** The depth of the entrance pit will depend on the depth of the service wire being placed, but a minimum of 10 inches is required to enter under the terminal base to provide a small amount of slack and soil protection to the service wire against the bottom edge of the terminal base.

**2.03** If crushed stone or pea gravel has been used as a protective measure against rodent damage to the cable or service wires, this should be carefully removed and replaced after the entrance of the service wire has been completed.

**2.04** Two elongated holes 5/16 x 1/2 inches placed in the bottom cover of the terminal approximately 12 inches from the bottom and 5

SECTION 631-600-100CA

inches apart will serve as an entrance for temporary service wires that are installed during the winter months for later trenching.

2.05 If service wires are placed at the same time as the cable and terminal a minimum length of 30 inches must be left in the terminal, above the ground clamp of the telephone bracket.



2.06 The armor of all service wires **must** be grounded to the ground clamp located on the ground bracket of the telephone sliding panel immediately upon placing.

2.07 The service wire can be attached to either one of the ground clamps. However, to assure good housekeeping, and to keep the terminal looking neat and clean, they should be attached on the opposite side of the terminal to which the lead wires from the connecting block are attached to the cable conductors as illustrated throughout this practice.

2.08 To terminate the armor of the service wire, pull approximately 30 inches of service

wire above the desired ground clamp. Mark the outer sheath 2 inches below the ground clamp and remove the outer sheath in the usual manner.

2.09 Unwrap and prepare approximately 3 inches of armor wire as shown in Fig. 1.

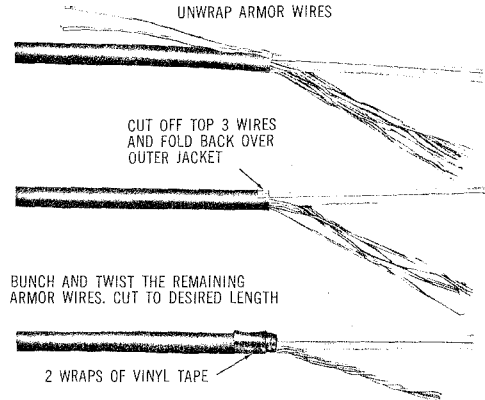
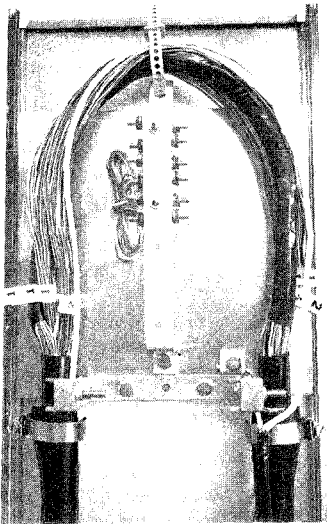
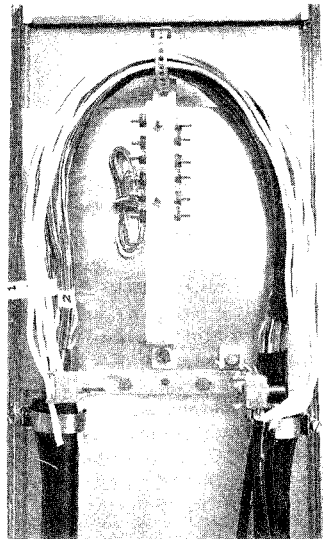


Fig. 1—Preparation of the Armor Wire



One Service Wire in place



Five Service Wires in place

Fig. 2

**2.10** Insert the armor of the service wire flush to the top of the ground clamp and tighten securely as shown in Fig. 2.

**2.11** A total of 5 service wires may be connected to either one of the service wire grounding clamps as shown in Fig. 2.

**2.12** An additional B. Cable tie must be secured around the cable and service wire conductors on the same side of the telephone panel that the service wire shield has been terminated on and placed at the midway point between the existing B. Cable tie which is located at the top of the telephone panel and the connection point of the service wire as shown in Fig. 3.

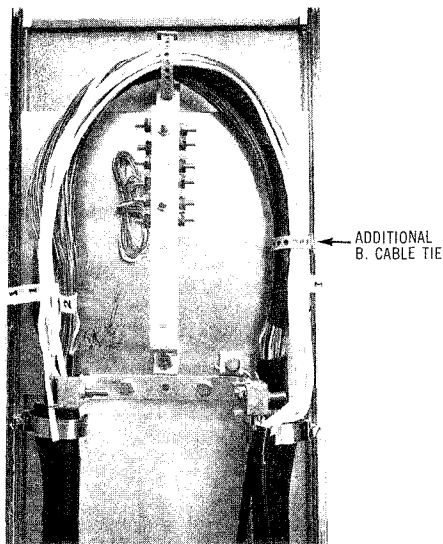


Fig. 3—Additional B. Cable Tie in place

### 3. DISPOSITION OF UNTERMINATED PAIRS

**3.01** Buried wire placed into the terminal and not put immediately into service must be protected to avoid differences in potential between the conductors and the metal armor. Buried wire not in use must be protected as follows:

#### (A) *At The Terminal End*

Place service wire and terminate armor as indicated in para.'s 2.06 to 2.10 inclusive.

#### (B) *At The Station End*

- (1) Where the wire is being terminated on a station protector at the time of placing. Connect in the usual manner as shown in 460 Section of Bell Canada practices.
- (2) Where the wire is *not* being terminated on a station protector at the time of placing remove the outer insulation from the armor wire and conductors. Twist the bare conductors and armor wire together and wrap with vinyl tape. Place the service wire in a neat coil or loop and tape the service wire back on itself using vinyl tape.

## 4. TERMINAL BLOCKS

### *Non-Protected Type*

**4.01** The QTC type terminals are furnished with one QBN-1B (6 Pair NON-PROTECTED TYPE) Terminal Block. (Fig. 4). Each binding post has a single, replaceable, 24-gauge wire lead assembly attached. The top (tip) posts have white leads and the bottom (ring) posts have blue leads.

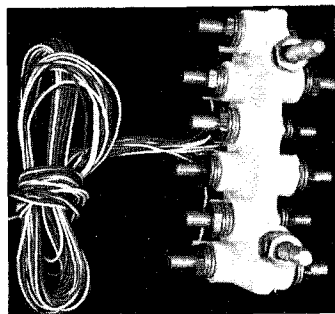


Fig. 4—QBN-1B Terminal Block

4.02 After the six binding post connections have been used an additional QBN-1C (3 Pair NON-PROTECTED TYPE) Terminal Block (see Fig. 5) may be placed in the second mounting position.

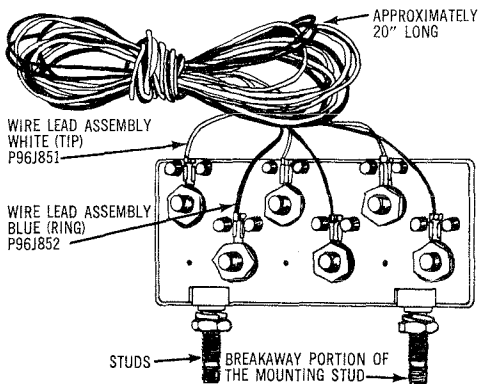


Fig. 5—QBN-1C Terminal

#### Protected Type

4.03 If cable pair protection is required the six pair block provided with the terminal is removed and a N3A1B-3 (3 pair, 6 Mil gap, protector unit) terminal block, Fig. 6, is installed.

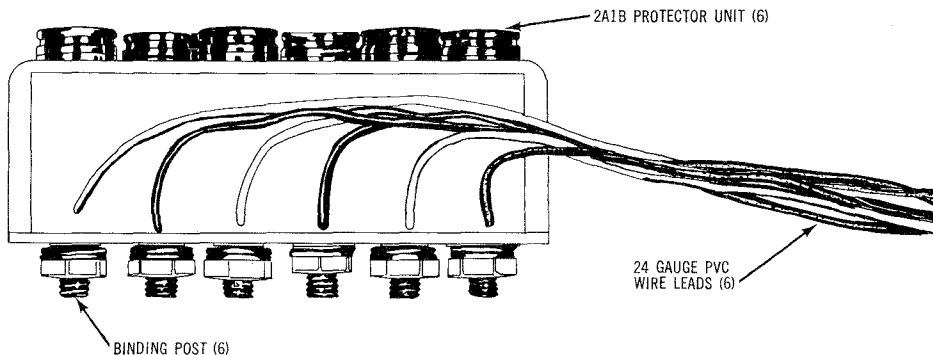


Fig. 6—N3A1B-3 Terminal Block

The 3 pair protector block is the same size as the 6 pair unprotected block and is installed in the same mounting holes.

4.04 When additional blocks are added to the terminal they must first be mounted on the telephone bracket and then the breakaway portion of the mounting stud removed to provide clearance for the placing of the terminal cover. The studs are designed with this break-off notch feature.

4.05 No more than two terminal blocks will be mounted in any QTC type terminal.

#### 5. BRIDGING CONNECTORS

5.01 The preferred method of joining the terminal block leads to the cable pairs assigned is with the SCOTCHLOK UG Bridging Connector. The use of UG Bridging Connectors eliminates the need to cut the cable conductors, thereby reducing the possibility of open conductors beyond the terminal and also improving housekeeping in the terminal.

5.02 The UG connector, Fig. 7, uses the insulation piercing quick-connect principle to join wires. The assembly contains a silicone grease for corrosion-proofing the completed wire joint.

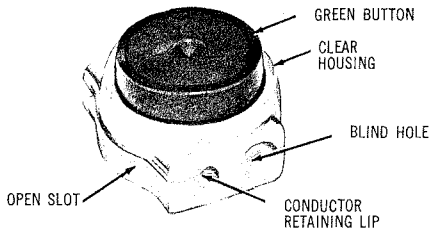


Fig. 7—Scotchlok UG Connector

5.03 The UG connector is distinguished from other connectors by a green compression button. The UG code is the manufacturers designation and has no relationship to underground plant.



5.04 Connectors are intended for use on PIC conductors ranging from 19 to 26 gauge and combinations of these gauges. *However, when the connector is used on 19 gauge conductors the insulation must be removed from the wire to ensure proper termination on the conductor.*

## 6. PREPARING AND CONNECTING TERMINAL BLOCK LEADS

6.01 The Terminal Block Wire leads are prepared and connected with SCOTCHLOK connectors as follows:

- (1) Separate the cable pair assigned from the assignable count binder group. Make certain that these conductors are not broken or damaged.
- (2) Take the terminal block leads which are connected to the binding posts and dress them through the two B Cable Tie retainers to a position in the straight portion of the cable run as shown in Fig. 8. This will provide the necessary length required for fusing protection and sufficient slack if rearrangement of the block lead should be required.
- (3) Bridge the tip and ring terminal block wire leads to the tip and ring conductors

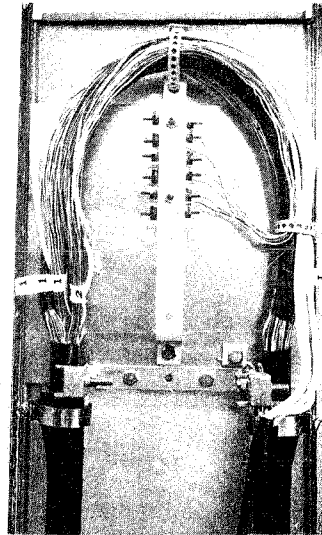


Fig. 8—Dressing Terminal Block Leads

of the assigned cable pair using UG SCOTCH-LOK connectors. Snap the type UG connector over the through wire selected, Fig. 9 and insert the terminal block wire into the connector part and squeeze the green button into the sleeve, using the "Z" Pressing Plier. When pressing the connector, make certain that the green button is pressed flush with the surface of the clear plastic connector housing Fig. 10.

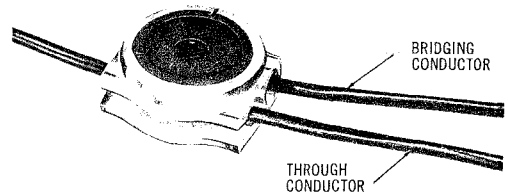


Fig. 9—Positioning Conductors into the Connector

SECTION 631-600-100CA

- The C Pressing Pliers must be used. Long-nosed, side-cutting, and adjustable or non-adjustable gas-type pliers with similar non-parallel jaw closure **must not** be used. This non-parallel jaw closure results in an initial cocking or tilting of the green button. The slotted metal insert is firmly attached to the button, and tilting introduces the possibility of cutting or nicking a conductor or improper seating of the conductor.

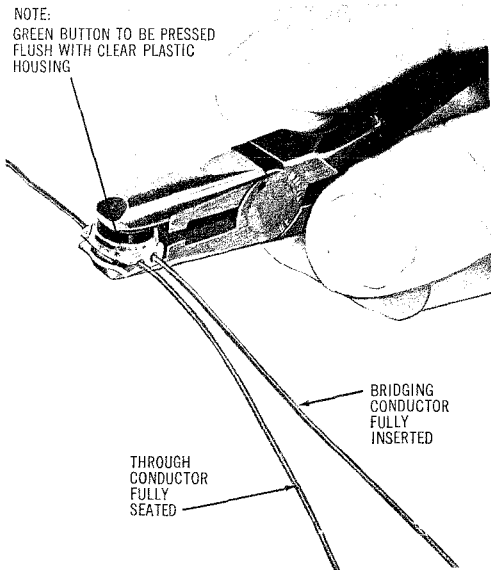


Fig. 10—Pressing UG Schotchlok Connector with Z Pressing Pliers

(4) The UG connectors should not be located any closer than 3 inches to the cable sheath as shown in Fig. 11. **DO NOT CUT THE CABLE CONDUCTORS.**

(5) Stagger the positions of the UG connectors. Fig. 12 shows the terminal block wire leads from binding posts positions, staggered and bridged to the cable conductors.

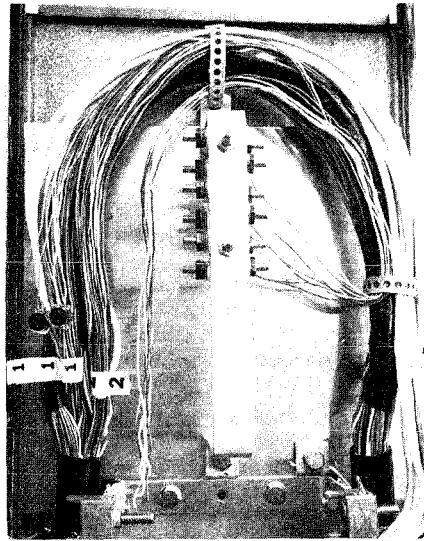
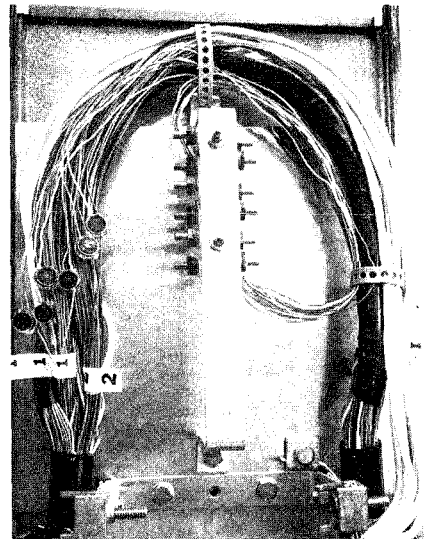


Fig. 11—Terminal Block Wire Leads connected to the Cable Conductors



NOTE THE UNASSIGNED  
TERMINAL BLOCK WIRE  
LEADS

Fig. 12—Staggering the UG Connectors

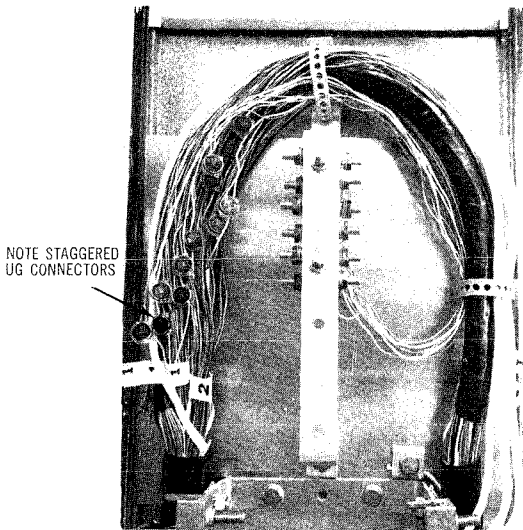


Fig. 13—First Terminal Block in place

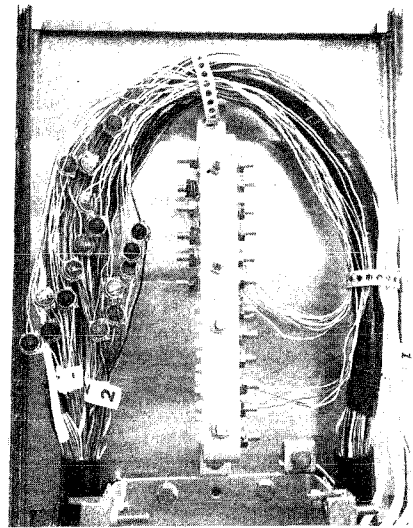


Fig. 14—Second Terminal Block in place

(6) Coil the unassigned Terminal Block wire lead assemblies in the vacant space behind the first terminal block.

(7) Fig. 13 shows the first terminal block in place with all terminal block wire lead assemblies connected to the cable conductors.

(8) Fig. 14 shows the second terminal block in place with all terminal block wire lead assemblies connected to the cable conductors.

(9) Protected type terminal blocks are installed on the telephone bracket and the wire leads connected to the cable conductors in a similar manner as that described for the non-protected type.

## 7. PREPARING AND TERMINATING SERVICE WIRE CONDUCTORS

7.01 The preferred method of preparing and terminating the conductors of buried service wire to the terminal blocks are as follows:

- (1) Remove the inner jacket of the service wire using the white nylon slitting cord,

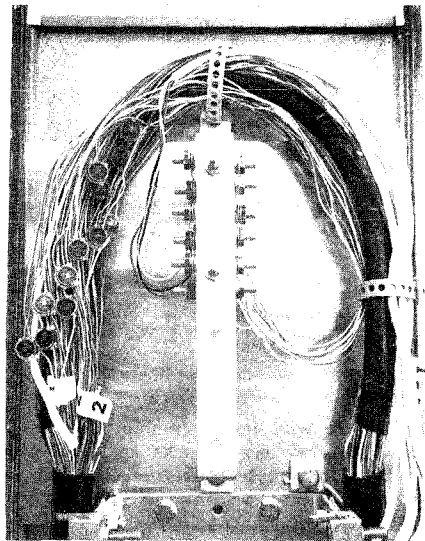


Fig. 15—Terminating Service Wire Conductors



to approximately 2 inches from the B Cable tie located on the top of the telephone panel as shown in Fig. 15.

(2) Dress the service wire conductors down past the binding posts to be connected, and then back up to the desired binding posts (forming a loop as shown in Fig. 15) using the entire length of service wire conductors.

(3) The red and green conductors of the service wire constitute the first pair and should be the initial pair terminated on the desired binding posts. The black and yellow constitute the second pair and should be terminated only after the red and green conductors have been assigned.

(4) The spare service wire conductors not immediately required should be neatly twisted or wrapped around the assigned pair of the service wire and left in an orderly fashion for future assignment.

(5) To ensure adequate slack in the service wire conductors in case of termination rearrangement remove only sufficient conductor insulation to permit termination.

(6) Form the bare conductor into a hairpin loop.

(7) Slacken the nut of the desired binding post and place the bare conductor loop around the binding post in a clockwise direction between the two binding post washers.

(8) Fig. 16 illustrates the first terminal block in place with all binding posts occupied and one spare service wire remaining.

(9) Fig. 17 illustrates the second terminal block in place with all binding posts occupied.

## 8. WIRE LEAD ASSEMBLY

8.01 Spare wire lead assemblies for the Non-Protected type blocks may be ordered separately to replace broken or defective leads. The ordering information is as follows:

Assembly Lead Wire PO96J851 — (White)

Assembly Lead Wire PO96J852 (Blue)

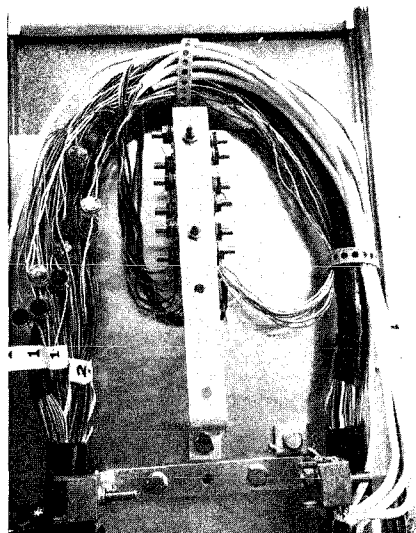


Fig. 16

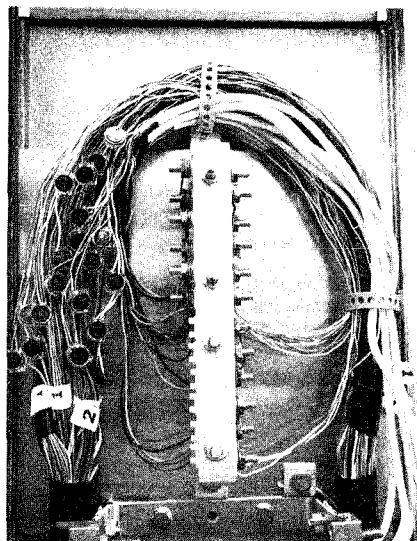


Fig. 17

The leads will be supplied in pkgs. of six as shown in Fig. 18.

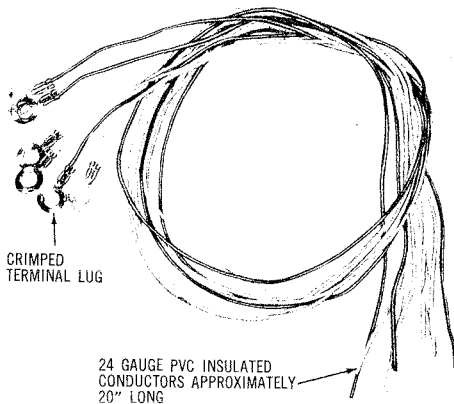
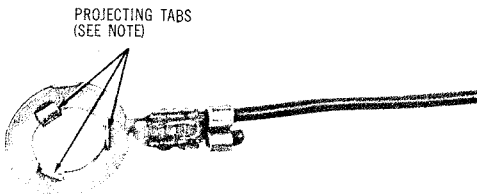


Fig. 18—Wire Lead Assembly

**8.02** The conductors are 24-gauge PVC insulated wire equipped with a crimped terminal lug at one end (Fig. 19).



NOTE: PLACE LUG ON BINDING POST WITH FLAT SURFACE TOWARD TERMINAL BLOCK FACE-PLATE AND TABS PROJECTING OUTWARD.

Fig. 19—Wire Lead Lug

**8.03** The lugs of the crimped wire tips are equipped with tabs which make the lugs captive to the binding posts when installed. The wire tips are installed on the binding posts as follows:

- (1) Remove the binding post nut and washers.
- (2) Remove the old lead as illustrated in Fig. 20.

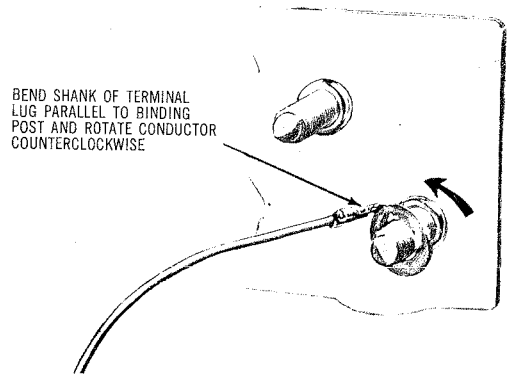


Fig. 20—Removing Binding Post Leads

(3) Select the wire tip of the appropriate colour coding; white for tip, and blue for ring.

(4) Place the wire tip lug on the binding post with the tabs projecting outward, away from the terminal block face plate.

(5) Place the binding post washer over the wire tip lug and firmly tighten the binding post nut. The pressure of the washer squeezes the lug tabs inward to engage the binding post threads.

## 9. REARRANGEMENTS

### Scotchlok UG Connectors

**9.01** When binding post leads already bridged to a cable pair with UG Connectors are to be reassigned to another cable pair, proceed as follows:

- (1) Cut the binding post leads as near as possible to the UG connectors. Do not attempt to remove the UG connectors from the cable pair conductors.
- (2) Separate the newly assigned cable pairs from the assignable count binder group. Make certain these pairs are not damaged.
- (3) Reconnect the binding post leads to the newly assigned cable pair as described in Part of this Practice.
- (4) Fig. 21 illustrates the rearrangement of three pairs of assigned binding post leads.

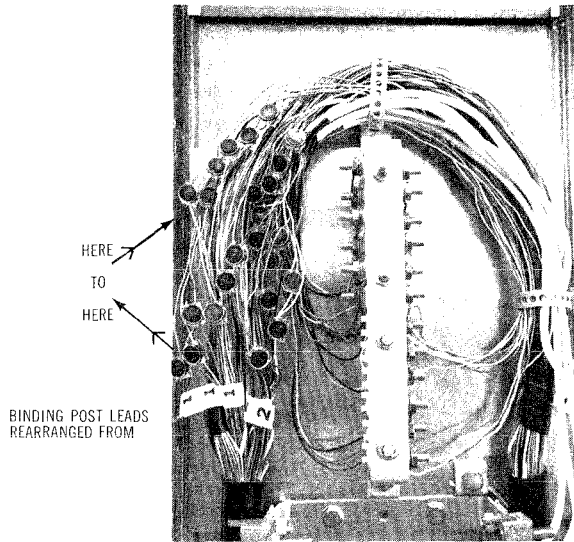


Fig. 21—Rearranging Binding Posts

## 4086B JWI CABINET

### PLACING AND REMOVING JUMPER WIRES

CONTENTS	PAGE
1. GENERAL . . . . .	585
2. OPENING CABINET . . . . .	585
3. CONNECTOR MODULES AND BINDING POST COUNT . . . . .	586
4. PLACING AND TERMINATING JUMPER WIRES . . . . .	587
5. REMOVING JUMPER WIRES . . . . .	589
6. USE OF TEST PROBE . . . . .	590
7. IDENTIFYING SPECIAL CIRCUITS . . . . .	590
8. CLOSING CABINET . . . . .	591

JWI Cabinet. To open the older type JWI Cabinet (Fig. 1) an NSQ2000L1 or other suitable tool must be used to loosen the locking bolt used to secure the locking latch. More recent models have the locking bolt located on the face of locking latch. This bolt requires only 1/4 turn to the left (counter-clockwise) using the same tool as indicated above. Caution must be used on this type of locking arrangement, since, excessive pressure applied on the locking bolt could damage the locking arrangement.

#### 1. GENERAL

1.01 This section describes the placing and removing of jumper wires, and associated information, required for interconnecting IN and OUT pairs in the 4086B JWI.

1.02 The cabinet description, installation, and cable placing instructions are described in section 631-620-910.



*Use only "Z" cross-connecting wire (24 GA.) for connecting "IN" and "OUT" pairs in the JWI. The use of jumper wire other than 24 gauge will permanently damage the connecting pins on the connector module. The wire is normally located on a storage spool in the top right hand corner of the cabinet.*

#### 2. OPENING CABINET

2.01 Two types of cabinet locking arrangements are used in connection with the

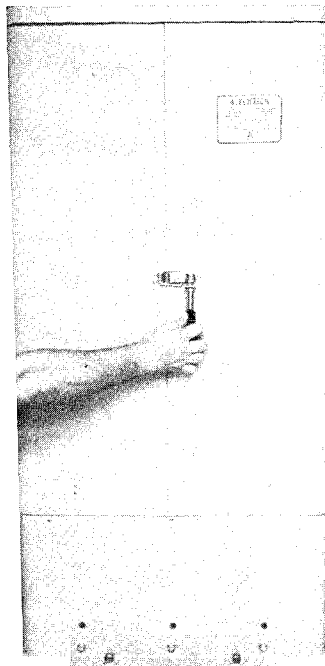


Fig. 1 — Opening Cabinet

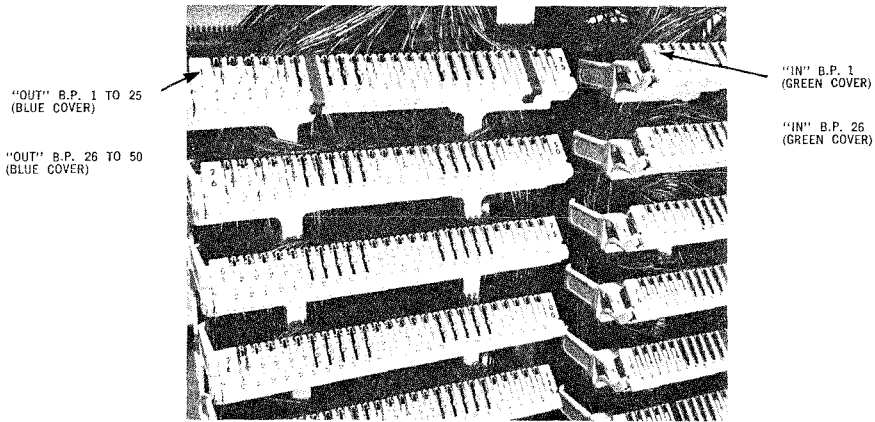
**3. CONNECTOR MODULES AND BINDING POST COUNT**

**3.01** To simplify assigning, and to assist in making connections, the *CONNECTING PINS* on the connector modules are referred to as **BINDING POSTS**.

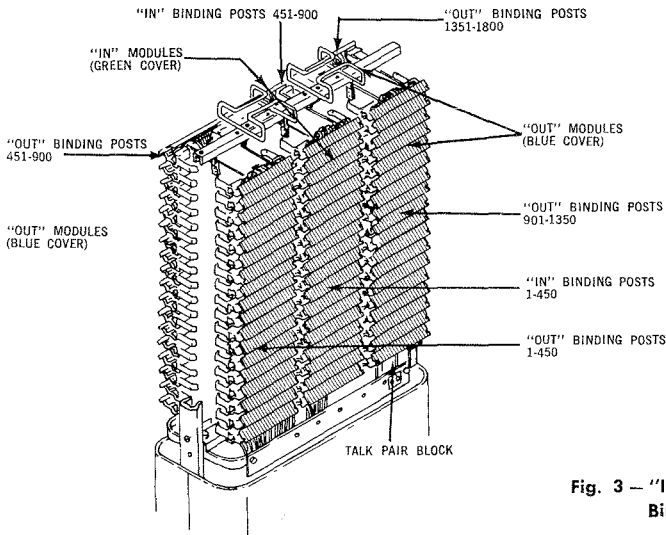
**3.02** The connector modules, for both the "IN" cables and "OUT" cables are stamped with

the first and last binding post number of the twenty-five pair connector module (Fig. 2).

**3.03** Connector modules that are equipped with "blue" covers represent the "OUT" or distribution cables and the "Green" covers represent the "IN" or feeder cables. The count of the binding posts is shown in Fig. 3.



**Fig. 2**



**Fig. 3 — "IN" and "OUT" Module Locations and Binding Post Counts**

3.04 To avoid the cross-over of jumper wires on the connector module, jumpers for the first thirteen binding posts on a module shall enter from the left side and the remaining twelve from the right. (See Fig. 4.)

“blue” field. To assist in locating the binding post in any given twenty-five pair connector module, the binding posts are grouped in units of five, designated by short and long marks on the module cover as shown in Fig. 5.

4. PLACING AND TERMINATING JUMPER WIRES

4.01 To place a jumper wire, start by locating the required “OUT” binding post in the

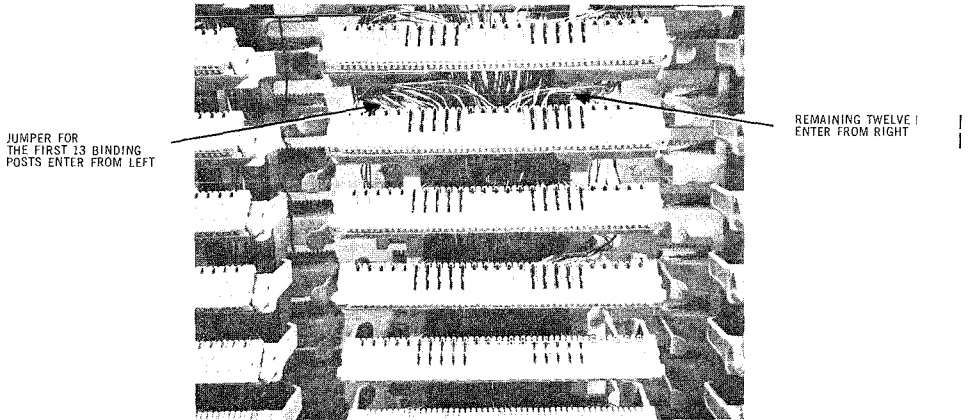


Fig. 4

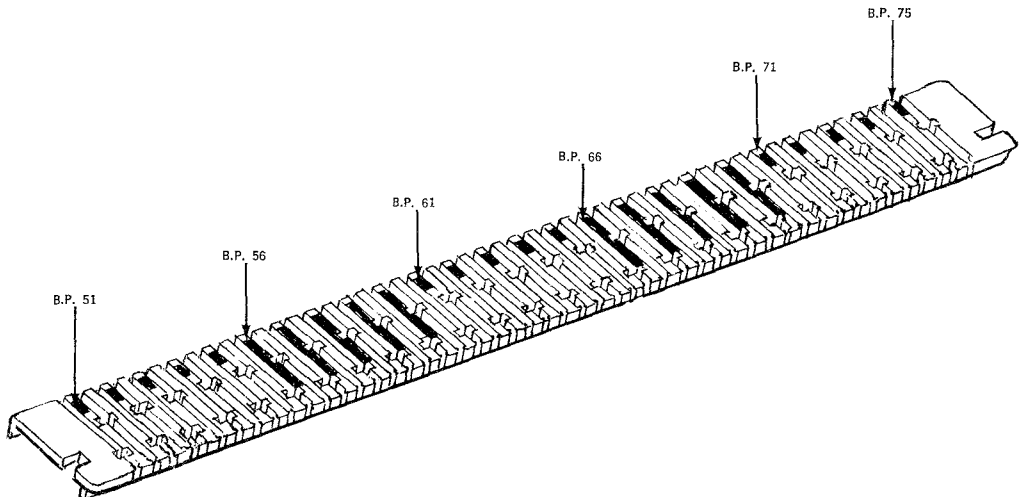


Fig. 5 — Connector Module Cover

4.02 Route one end of the jumper wire ("Z" Cross-Connecting Wire) down and behind the wiring channels in the "OUT" cable field. (See Fig. 6.)

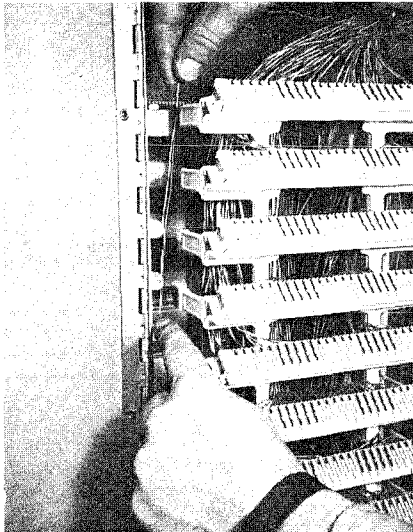


Fig. 6 — Routing Jumper Wire

4.03 Bring the wire out and over the connector module cover on which the wire is to be terminated. Split the pair over the black mark on the module cover, placing the tip wire (yellow with blue trace) to the left and the ring wire (blue with yellow trace) to the right. (See Fig. 7.)



*Hold the wire in place with the fore-finger and push the jumper down until it definitely snaps into both the rear and forward catch areas of the cover. (See Fig. 8.)*

4.04 To terminate the jumper wire on the binding post, insert the impact tool in the channel slot, perpendicular to the surface of the module with the flag portion of the head of the tool facing the rear of the module Fig. 9.

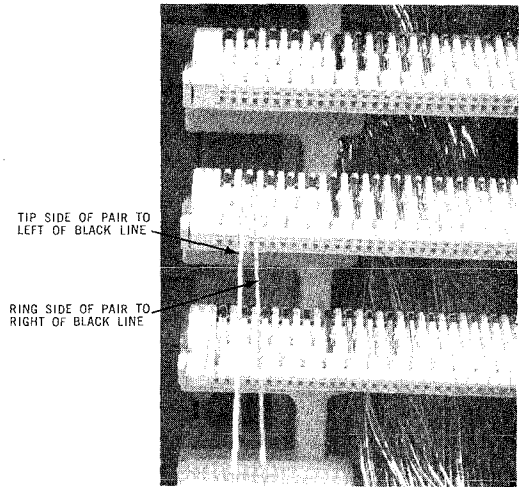


Fig. 7

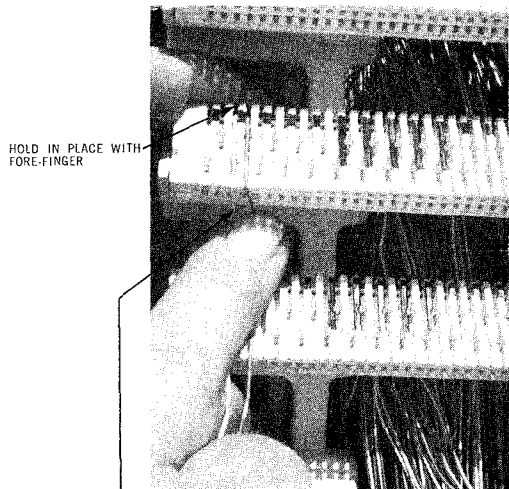
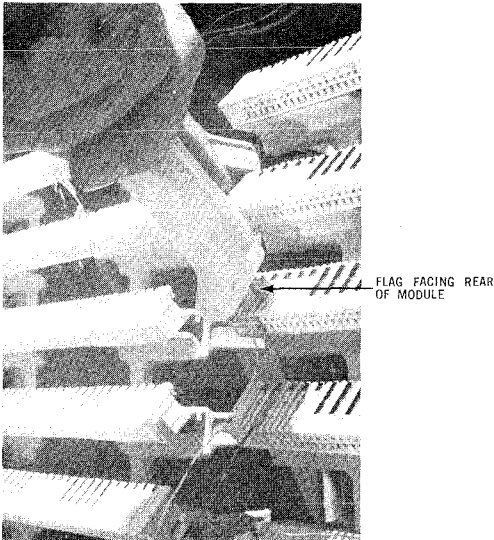


Fig. 8

**4.05** Compress the impact tool completely, until the impact is heard in the tool. This will seat and terminate the jumper wire, as well as cut the excess length of jumper wire.

**4.06** Route the jumper wire from the "OUT" binding posts (blue covers) up the wiring channel. **LAY THE WIRE INTO, AND COM-**



**Fig. 9**

**PLETELY THROUGH, ONLY ONE SET OF JUMPER WIRE CHANNELING RINGS** on top of the terminating frame, as shown in Fig. 10. Continue the jumper wire down the wiring channel of the "IN" binding posts (green covers) to the desired location and terminate as outlined in Para. 4.01 to 4.06.

*Note:* Allow 1-1/2" to 2-1/2" of slack in jumper wire prior to terminating.

**4.07** The talk pair block is to be connected to a terminated cable pair by running a jumper wire from the block to the desired binding post location. The direct connection of a cable pair to the talk pair block is not allowed.

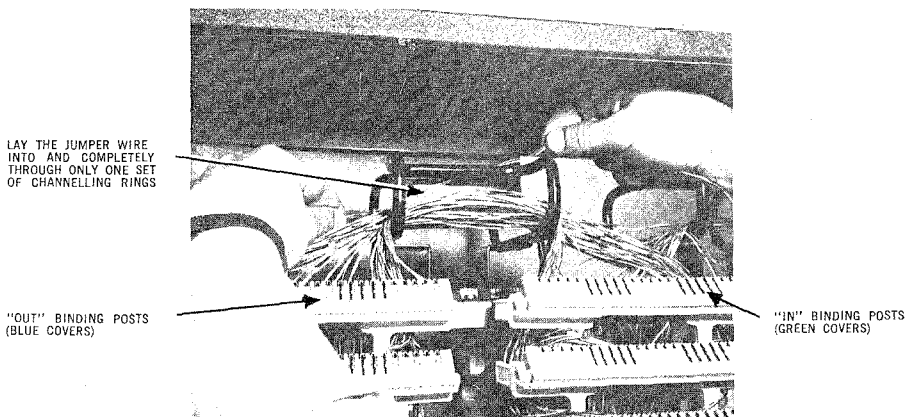


*Care should be taken when placing jumper wires in the JWI. Improper or poorly run jumper wires contribute to service interruptions, jumper wire build up, difficulty in pair tracing, and a general overall poor housekeeping condition.*

**5. REMOVING JUMPER WIRES**

**5.01** A disconnected jumper wire must be removed in its entirety.

**5.02** Before removing any jumper wires, locate and verify the binding posts to which it is connected.



**Fig. 10**



SECTION 631-620-912CA

5.03 Grip the jumper wire, using long nose pliers, approximately 1/4" in rear of module. (See Fig. 11.)

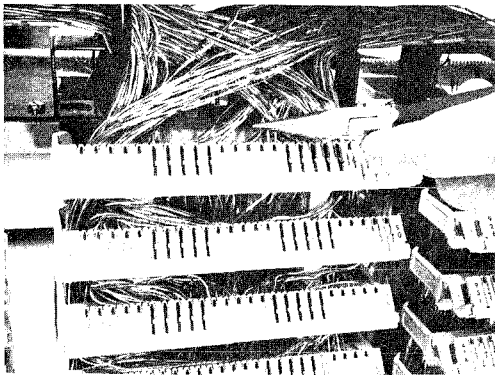


Fig. 11 — Removing Jumper Wire

5.04 Carefully pull on the jumper in an upward direction till it is released from the module.

5.05 Repeat the above for the remaining connection on the "IN" or "OUT" binding post.

6. USE OF TEST PROBE

6.01 The method of placing the test probe is shown in Fig. 12.

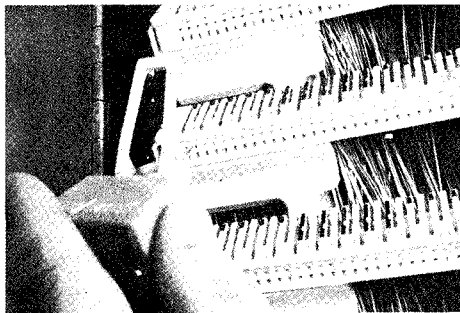


Fig. 12 — Installing Test Probe

6.02 The test probe, shown installed in Fig. 13, provides a means of connecting to a cable pair for proving circuits, testing, etc.

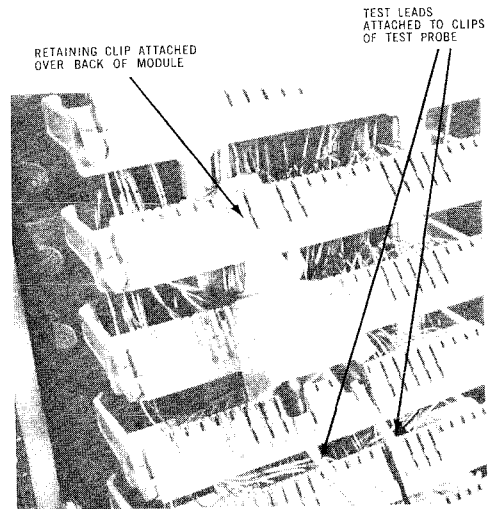


Fig. 13 — Test Probe Installed

7. IDENTIFYING SPECIAL CIRCUITS

7.01 When cable pairs are used for special services, it will be necessary to identify and protect the circuit by placing binding post caps over the binding posts at both appearances in the JWI. (Fig. 14.)

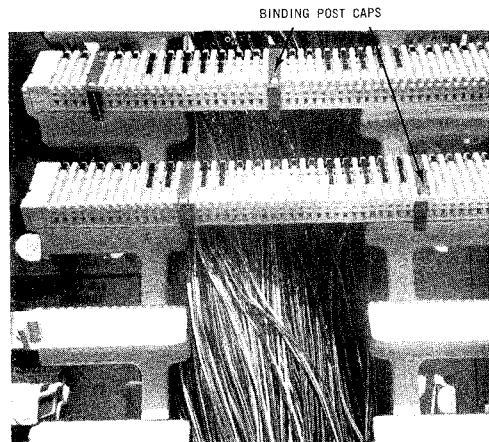


Fig. 14

**7.02** Place the cap over the pair to be protected, ensuring that the guides on the sides of the cap are locked in their proper location of the module cover.

**7.03** Once the cap is placed over the pair to be protected, insert the two plastic tips located on the bottom area of the cap into the mid-level test ports of the module.

## **8. CLOSING CABINET**

**8.01** Visually inspect the interior of the cabinet for good housekeeping and a neat orderly appearance.

**8.02** In closing the cabinet doors, models with the locking bolt located on the face of the latch will lock automatically when the door is closed. Other models should have the latch secured by tightening the Locking Bolt using a NSQ2000L1 or other similar tool. DO NOT OVERTIGHTEN.



*Before leaving the cabinet location, remove all scraps of material and other debris which may have accumulated around the JWI during the working operations.*



**DEDICATED PLANT**  
**WIRING AND CONNECTING ARRANGEMENTS**  
**POLE AND WALL MOUNTED CABINETS FOR**  
**CONTROL AND ACCESS POINTS**

CONTENTS	PAGE
1. GENERAL . . . . .	593
2. HARDWARE . . . . .	593
3. CONTINUOUS PIC SHEATH COUNT . . . . .	594
4. INSTALLATION OF IN AND OUT CABLES . . . . .	595
5. CABLE PREPARATION AND BINDER GROUP IDENTIFICATION . . . . .	595
6. CAPPING SPARE IN PAIRS . . . . .	596
7. WIRING . . . . .	596
8. CONNECTING . . . . .	597
9. VERIFICATION OF PAIR COMMITTED (C.P. to A.P.) . . . . .	598
10. IDENTIFYING SPECIAL CIRCUITS . . . . .	598
11. TALKING CIRCUIT . . . . .	598
12. LENGTHENING PAIRS . . . . .	598
13. OBSOLETE TYPES . . . . .	599

**1. GENERAL**

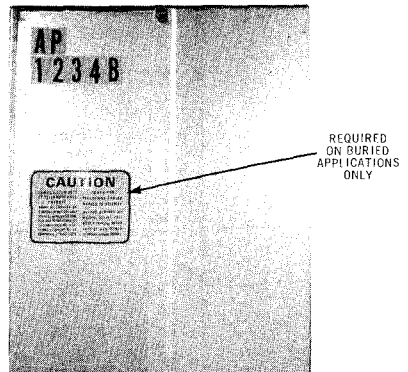
**1.01** This section is reissued to revise the wiring and connecting arrangements for the 29Q2B Cabinet for use as an access or control point.

**1.02** The 29Q3B and 29Q4B Cabinets are now obsolete. Brief information on the obsolete types is retained to cover those in plant.

**1.03** The 29Q2B Cabinet is capable of holding a maximum of 900 pairs IN and 1,000 pairs OUT, and can be mounted either on pole or wall.

**2. HARDWARE**

**2.01** (a) *Insignia Adhesive*: used for identifying control and access points. The insignia C and P will designate a control point while A and P will be used to designate an access point. (See Fig. 1).



**Fig. 1**

(b) *Cable Unit Markers*: used to identify individual groups in the cables.

(c) *Channel Rings*: are included in the 29Q2B, 29Q3B and 29Q4B for routing of the cable pairs within the cabinet.

(d) *E Plastic Caps*: used with plugging compound for clearing and capping the ends of the IN Cable binder groups at cable ends. The caps come in different sizes which are able to accommodate cables up to 3 inches.

**SECTION 642-220-201CA**

- (e) **Plastic Bags:** used with plugging compound for clearing and capping the ends of the IN cable binder groups at cable ends. The bags come in two sizes 4" x 8" and 3" x 5".
- (f) **B Wire Connectors:** used to connect IN cable pairs to OUT cable pairs. They are pressed on the conductors with a B Connector Presser.
- (g) **Warning Marker Form E-5190:** used to identify special circuits. This tape is mounted on dispenser cards and when required, is peeled off the card and wrapped around the "B" Wire Connector.

**3. CONTINUOUS PIC SHEATH COUNT**

**3.01** Continuous PIC Sheath Count is a technique for identifying groups in control and access points.

**3.02** Continuous PIC Sheath Count aids in making the pair connections and identi-

fication within a control or access point cabinet and is accomplished by assigning:

- (a) A consecutive pair count starting with pair one to all of the IN cable pairs appearing in the cabinet regardless of the number of cable sheaths involved.
- (b) A consecutive pair count starting with pair one to all of the OUT cable pairs appearing in the cabinet regardless of the number of cable sheaths involved.
- (c) Binder group markers of both IN and OUT cables will be made continuous to correspond to these pair counts as shown in Table A.

By this technique, each control or access point will appear to have only one IN and one OUT cable; thus, making pair identification easier.

**3.03** If a cable stub entering a control or access point contains both IN and OUT pairs, the cable will be identified accordingly. The centre groups of the cable should contain the OUT cable pairs.

TABLE A					
CONTINUOUS PIC SHEATH COUNT AND BINDER GROUP COLOUR AND NUMBER					
Cable Unit Marker No.	Continuous PIC Sheath Count	Binder Group Color	Cable Unit Marker No.	Continuous PIC Sheath Count	Binder Group Color
1	1-25	Bl-W	21	501-525	Bl-V
2	26-50	O-W	22	526-550	O-V
3	51-75	G-W	23	551-575	G-V
4	76-100	Br-W	24	576-600	Br-V
5	101-125	S-W	25	601-625	Bl-W, R
6	126-150	Bl-R	26	626-650	O-W, R
7	151-175	O-R	27	651-675	G-W, R
8	176-200	G-R	28	676-700	Br-W, R
9	201-225	Br-R	29	701-725	S-W, R
10	226-250	S-R	30	726-750	Bl-R, R
11	251-275	Bl-Bk	31	751-775	O-R, R
12	276-300	O-Bk	32	776-800	G-R, R
13	301-325	G-Bk	33	801-825	Br-R, R
14	326-350	Br-Bk	34	826-850	S-R, R
15	351-375	S-Bk	35	851-875	Bl-Bk, R
16	376-400	Bl-Y	36	876-900	O-Bk, R
17	401-425	O-Y	37	901-925	G-Bk, R
18	426-450	G-Y	38	926-950	Br-Bk, R
19	451-475	Br-Y	39	951-975	S-Bk, R
20	476-500	S-Y	40	976-1000	Bl-Y, R

#### 4. INSTALLATION OF IN AND OUT CABLES

4.01 The IN Cable Pairs from the switching centre must enter on the left hand side as viewed from the front of the cabinet and the OUT Cable Pairs on the right side.

4.02 To help channelling the cables the channels may be removed from the cabinet.

4.03 To provide for adequate slack for wiring, cut the cables in the cabinet as follows:

IN cable entering from the top, 50" from the point of entrance into the cabinet.

IN cable entering from the bottom, 80" from the point of entrance into the cabinet.

OUT cable leaving from the top, 60" from the point of entrance into the cabinet.

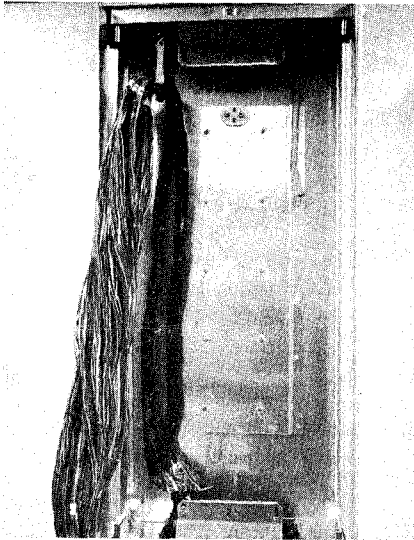


Fig. 2 — Taping of Cable Pairs in Group of 200 Pairs

OUT cable leaving from the bottom, 90" from the point of entrance into the cabinet.

4.04 The IN and OUT cables entering from the bottom of the cabinet must be taped in groups of 300 pairs or less if necessary from the point of entrance to the slack wire chain at the top. (See Fig. 2).

4.05 *Grounding Method:* The cable shall be grounded to the cabinet as described in Division 638 on "Z" Bond Clamp.

#### 5. CABLE PREPARATION AND BINDER GROUP IDENTIFICATION

5.01 To facilitate pair connection and identification in control and access points a continuous PIC Sheath Count will be established for all IN and OUT cables. This method is described in Part 3 of this section.

5.02 It will be necessary in many cases to mark the binder groups with a number identification which differs from that normally associated with the cable sheath in accordance with the Continuous PIC Sheath Count Method.

5.03 Identify the IN and OUT cables using the Dymo Tape Writer. The Dymo Tag should include the word IN or OUT according to the cables' designation, plus the count of the cable.

5.04 Before removing the unit binder, wrap each binder group of the IN and OUT cable (or cables) with the cable unit marker using the number that corresponds with the group. (e.g., Blue, White — No. 1) unless a change is required to correspond to the Continuous PIC Sheath Count. Place the markers both near the sheath opening and at the clear and capped end of the IN cable. (See Fig. 3).

5.05 The continuous PIC Sheath Count and the unit marker to use for binder group identification ties are listed in Table A.

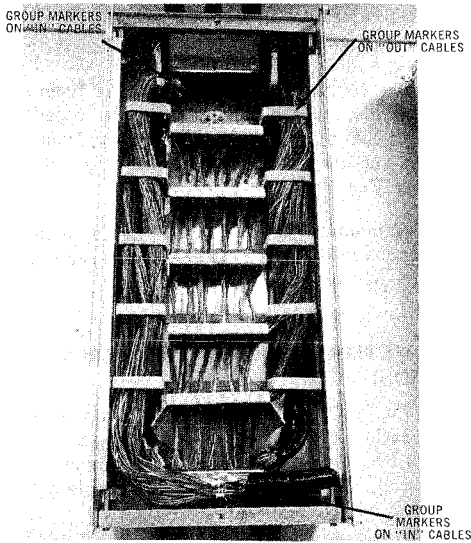


Fig. 3 - Installation of Unit Group Markers

**6. CAPPING SPARE IN PAIRS**

**6.01** Clear the ends of the spare IN cable pairs using a plastic bag or B Plastic Cap as described in appropriate section in Division 633.

**7. WIRING**

**7.01** Route the IN and OUT cables along the sides of the cabinet. The IN cable must be routed along the left side, the OUT along the right.

**7.02** Clear the IN cable pairs as per Part 6. Ensure that there will be enough slack in the wires to permit the making of the connections at the extreme right hand side of the bottom wiring bracket.

**7.03** Replace the Channelling Rings that were removed from the cabinet prior to the installation of the cables.

**OUT Cables**

**7.04** Route the OUT pairs or groups directly over the channelling ring at the level which they are to be spliced if they enter the cabinet from the bottom. If the cable enters the cabinet from the top the pairs or groups will be routed under the channelling ring, at the appropriate level.



Fig. 4

**7.05** Route the OUT cable binder groups across the top of the wiring brackets. The binder group colour codes must correspond to the colour code on the front of the distributing bracket. (See Fig. 4)

**7.06** Feed each 25 pair binder group through the back row of holes in the wiring bracket in accordance with the colour code and pair count indicated on the front of the distributing bracket. Figures 3, 4 and 5 give a top view of the distributing brackets.

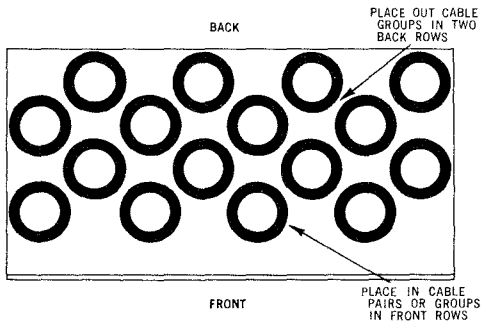


Fig. 5 — Distribution Bracket For 29Q2B (Top View)

7.07 Cut each binder group to a length of 12 to 15 inches below the bottom of the bracket to preserve the pair twist. Install a single wire tie near the end of the binder group. (See Fig. 6).

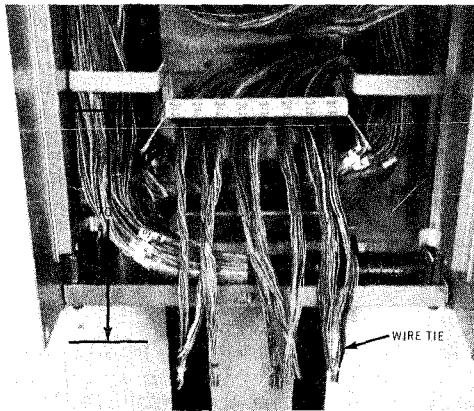


Fig. 6

7.08 Select a pair and pull from the single wire tie. Pull the pair taut, to remove any slack and cut the pair from 6 to 8 inches below the bottom of the distributing bracket.

7.09 Apply from four to six twists in the cable pair as close to the bottom of the wiring bracket as possible. This prevents splitting of the OUT pair. (See Fig. 7).



Fig. 7

7.10 Repeat Paras. 7.08 and 7.09 for each pair of the binder group and using the top of the next lower distributing bracket as a guide, cut all pairs of the group. This assures a uniform length for the binder group.

7.11 Secure the pairs in the binder group by wrapping with a single wrap of wire twisted together to bind the group together.

7.12 Repeat procedures outlined in Paras. 7.07 through 7.11 for the remaining binder groups. Pairs through the lower bracket should be cut to the same length as the other pairs.

## 8. CONNECTING

8.01 Select and cut the IN cable pair from the capped binder group.

8.02 Pull the selected IN cable pair from the binder group immediately below the group marker which is located at the cable sheath opening at the top of the cabinet. **DO NOT** remove the selected pair from the binder group identification marker at the cable sheath opening.

8.03 Rerun the selected IN pair through the channelling rings, on the right of the spare



## SECTION 642-220-201CA

IN pairs to the appropriate splicing level. Care must be exercised to avoid tying in the spare IN pairs.

**8.04** Place the IN cable pair through the front hole of the distributing bracket corresponding to the OUT cable pair.

**8.05** Pull the IN cable pair taut to remove slack and cut to the same length as the binder group containing the OUT cable pair.

**8.06** Remove the selected OUT pair from the wire wrap and connect the IN cable pair to the OUT cable pair using "B" Wire Connectors. Do not remove the OUT pairs from the rear hole of the wiring bracket.

**8.07** Repeat Paras. 8.01 through 8.06 to connect any additional IN cable pairs to OUT cable pairs.

**8.08** When splicing keep the pairs taut and pigtail the pairs together at the point where they meet.

### 9. VERIFICATION OF PAIRS COMMITTED (C.P. to A.P.)

**9.01** At time of committing pairs through a C.P. to feed an A.P., one pair in each 25 pair group (committed in whole or part) shall be tested between the C.P. and A.P. to ensure pair continuity and correct binder group sequence.

### 10. IDENTIFYING SPECIAL CIRCUITS

**10.01** When a cable pair is used for a special service, it will be necessary to identify the circuit by wrapping a red warning marker tape around each of the "B" Wire Connectors that are used to splice the IN and OUT pair.

### 11. TALKING CIRCUIT

**11.01** If a talking circuit is assigned connect the cable pair to the terminal block which is located immediately above the top distributing bracket as outlined in Paras. 11.02 to 11.04.

**11.02** Cut the assigned talk pair from the capped binder group and pull the pair from the

binder group immediately below the binder group marker which is located at the top of the cabinet.

**11.03** Route the talk pair around the top left hand channelling ring and directly to the terminal block.

**11.04** Strip the insulation from the ends of the talk pair and terminate by wrapping the wires around the binding post of the terminal block and tighten the nuts.

## 12. LENGTHENING PAIRS

### OUT Cable Pairs

**12.01** If an OUT cable pair is too short, lengthen the conductors as follows:

(a) Obtain a length of wire having the same coloured insulation and gauge as the cable pair to be lengthened.

(b) Cut the ends of the OUT cable conductors that are to be lengthened and the lengthening conductors square at a suitable location in the wiring channel, insert the B Wire Connectors and press.

(c) Route the lengthened wires through the distributing ring and place through the assigned rear hole of the wiring bracket and apply four to six tight twists to prevent pair splitting.

### IN Cable Pairs

**12.02** The IN cable pairs which have been disconnected from OUT pairs or cut from the cleared and capped end and are not to be used immediately must be cleared and dressed as described below:

(a) Lengthen the pair as described in Para. (12.01 (a) and (b)).

(b) Route the wires through the distributing rings along with the remaining IN spare pairs of the *same binder group*.

(c) Cut the pair the same length as the rest of the IN spare pairs.

(d) Clear the end of the pair by placing a "B" Wire Connector on *each individual* wire.

(e) Tape the wires to their respective binder group near the cleared end of the IN pair stub.

and is capable of holding a maximum of 200 OUT pairs. (See Fig. 8).

**13. OBSOLETE TYPES 29Q3B and 29Q4B**

**29Q4B**

**29Q3B**

13.02 The 29Q4B was used as a control or access point and is capable of holding a maximum of 450 OUT pairs. (See Fig. 9).

13.01 The 29Q3B was used as an access point

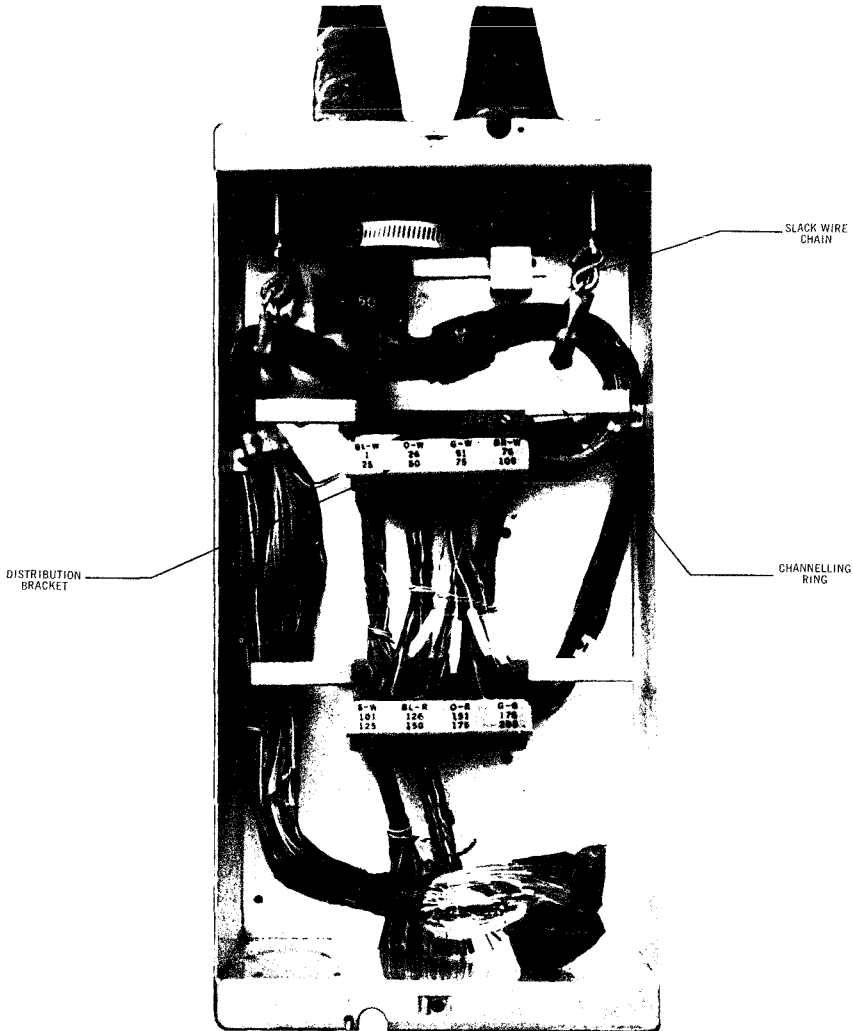


Fig. 8 - 29Q3B with IN and OUT Cables

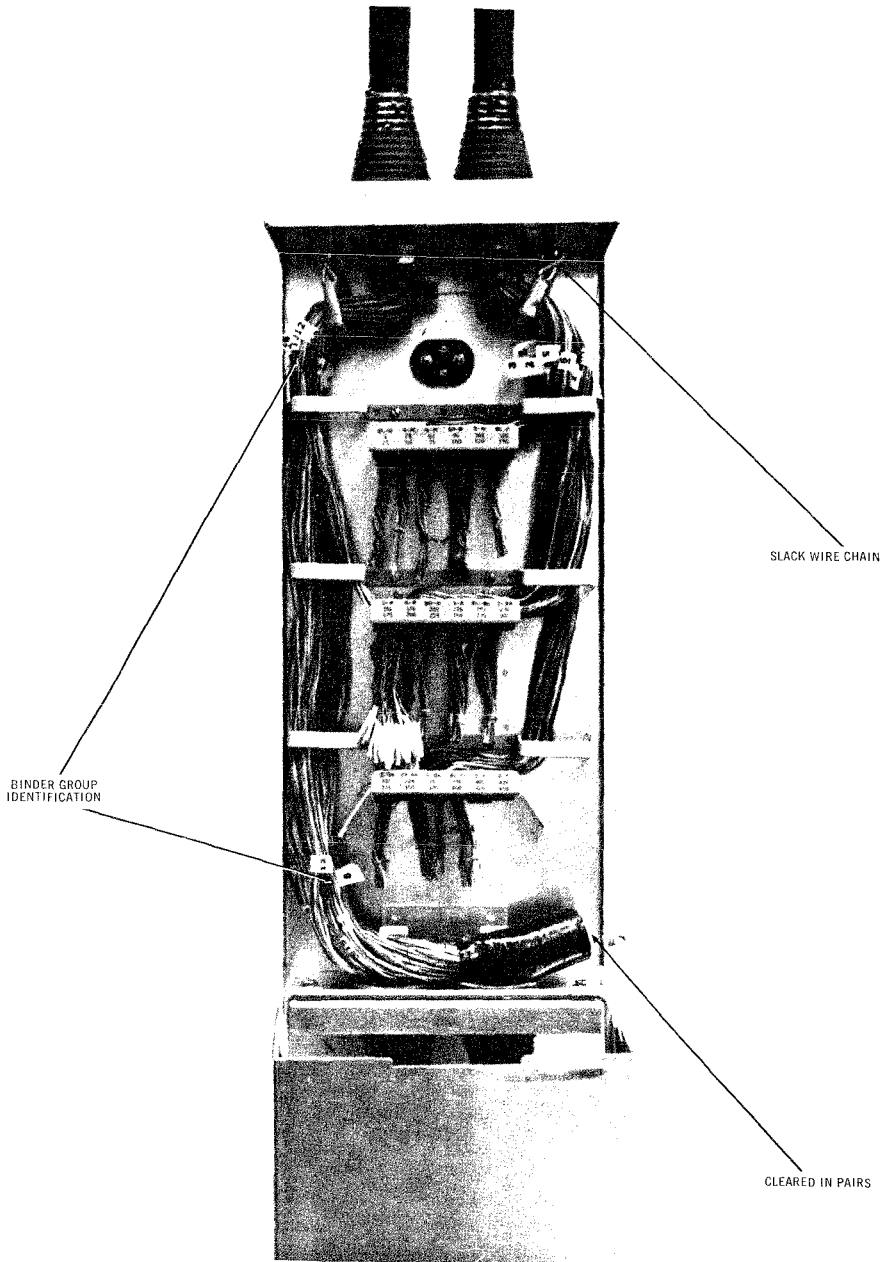


Fig. 9 — 29Q4B Wired

**DEDICATED PLANT**  
**BURIED CABLE — CONTROL AND ACCESS POINTS**  
**WIRING ARRANGEMENTS**

CONTENTS	PAGE
1. GENERAL . . . . .	601
2. HARDWARE . . . . .	601
3. CONTINUOUS PIC SHEATH COUNT . . . . .	602
4. CABLE INSTALLATION . . . . .	606
5. CABLE PREPARATION AND BINDER GROUP IDENTIFICATION . . . . .	608
6. CAPPING SPARE IN CABLES . . . . .	608
7. CONNECTING IN THE QCH1C . . . . .	608
8. WIRING & CONNECTING THE QCH2C . . . . .	613
9. WIRING AND CONNECTING THE QCH12B . . . . .	616
10. VERIFICATION OF PAIRS COMMITTED (C.P. To A.P.) . . . . .	619
11. IDENTIFYING SPECIAL CIRCUITS . . . . .	619
12. TALKING CIRCUIT . . . . .	619
13. LENGTHENING PAIRS . . . . .	619

**1. GENERAL**

**1.01** The capacities listed in Paras. 1.03, 1.04 and 1.05, reflect the use of 80 Type distribution brackets to permit identification of the "OUT PIC Stub Cable" by twenty-five pair binder groups. Under no conditions should these capacities be exceeded.

**1.02** This section is revised to update general information. Arrows ordinarily used to indicate changes have been omitted.

**1.03** The QCH1C is now obsolete, but was used as a control or access point and was capable of holding a maximum of 600 IN and 600 OUT pairs with 24 or 26 gauge. The total number of IN pairs is less, if coarser gauge is used. A maximum of 6 cable sheaths could be terminated in a QCH1C.

**1.04** The QCH2C is now obsolete but was used as a control or access point and was capable of holding a maximum of 400 IN and 300 OUT pairs with 24 or 26 gauge. Total number of IN pairs is less, if coarser gauge was used. A maximum of 4 cable sheaths could be terminated in a QCH2C.

**1.05** The QTC12B may be used as a control or access point. Optional panels are available to accept up to a maximum of 900 IN and OUT pairs with 24 or 26 gauge. Total number of IN pairs is to be decreased when coarser gauge is used. A maximum of 6 cable sheaths may be terminated in a QTC12B.

**1.06** The QTC11A is used simultaneously as a control and access point under the same closure. The capacities are the same for both the control and access point. A maximum of 900 IN and 900 OUT pairs are permitted in each, control and access point. A maximum of 6 cable sheaths may be terminated in each, control and access point.

**2. HARDWARE**

**2.01**

(a) *Plastic Bags:* used with plugging compound for clearing and capping the ends of the IN cable binder groups at cable ends. The bags come in two sizes 4" x 8" and 3" x 5". B Plastic Cap may be substituted.

## SECTION 642-235-202CA

(b) **B Wire Connectors:** used to connect IN cable pairs to OUT cable pairs. They are pressed on the conductors with a B connector presser as described in Division 632.

(c) **Warning Marker Form E-5190:** used to identify special services circuits. This tape is mounted on dispenser cards and when required is peeled off the card and wrapped around the B Wire Connector.

(d) **Insignia Adhesive:** are used for identifying control and access points. The insignia C and P will designate a control point while A and P will be used to designate an access point.

(e) **Cable Unit Markers:** used to identify individual binder groups in the cables.

### 3. CONTINUOUS PIC SHEATH COUNT

**3.01** Continuous PIC Sheath Count is a technique for identifying groups in Control and Access Points.

**3.02** Continuous PIC Sheath Count aids in making the pair connections and identification

within a control or access point closure and is accomplished by assigning:

(a) A consecutive pair count starting with pair one to all of the IN cable pairs appearing in the closure regardless of the number of cable sheaths involved.

(b) A consecutive pair count starting with pair one to all of the OUT cable pairs appearing in the closure regardless of the number of cable sheaths involved.

(c) Cable Unit Markers of both IN and OUT cables will be made continuous to correspond to these counts as shown in Table A. By this technique, each control or access point will appear to have only one IN and one OUT cable; thus, making pair identification easier.

(d) If a cable stub entering a control or access point contains both IN and OUT pairs the cable will be identified accordingly. The centre groups of the cable will normally contain the OUT cable pairs.

TABLE A

## CONTINUOUS PIC SHEATH COUNT AND BINDER GROUP COLOUR

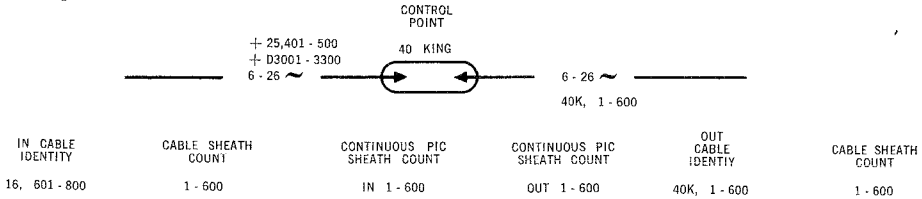
Cable Unit Marker No.	Continuous PIC Sheath Count	Binder Group Colour	Cable Unit Marker No.	Continuous PIC Sheath Count	Binder Group Colour	Cable Unit Marker No.	Continuous PIC Sheath Count	Binder Group Colour
1	1-25	Bl-W	25	601-625	Bl-W, R	49	1201-1225	Bl-W, Bk
2	26-50	O-W	26	626-650	O-W, R	50	1226-1250	O-W, Bk
3	51-75	G-W	27	651-675	G-W, R	51	1251-1275	G-W, Bk
4	76-100	Br-W	28	676-700	Br-W, R	52	1276-1300	Br-W, Bk
5	101-125	S-W	29	701-725	S-W, R	53	1301-1325	S-W, Bk
6	126-150	Bl-R	30	726-750	Bl-R, R	54	1326-1350	Bl-R, Bk
7	151-175	O-R	31	751-775	O-R, R	55	1351-1375	O-R, Bk
8	176-200	G-R	32	776-800	G-R, R	56	1376-1400	G-R, Bk
9	201-225	Br-R	33	801-825	Br-R, R	57	1401-1425	Br-R, Bk
10	226-250	S-R	34	826-850	S-R, R	58	1426-1450	S-R, Bk
11	251-275	Bl-Bk	35	851-875	Bl-Bk, R	59	1451-1475	Bl-Bk, Bk
12	276-300	O-Bk	36	876-900	O-Bk, R	60	1476-1500	O-Bk, Bk
13	301-325	G-Bk	37	901-925	G-Bk, R	61	1501-1525	G-Bk, Bk
14	326-350	Br-Bk	38	926-950	Br-Bk, R	62	1526-1550	Br-Bk, Bk
15	351-375	S-Bk	39	951-975	S-Bk, R	63	1551-1575	S-Bk, Bk
16	376-400	Bl-Y	40	976-1000	Bl-Y, R	64	1576-1600	Bl-Y, Bk
17	401-425	O-Y	41	1001-1025	O-Y, R	65	1601-1625	O-Y, Bk
18	426-450	G-Y	42	1026-1050	G-Y, R	66	1626-1650	G-Y, Bk
19	451-475	Br-Y	43	1051-1075	Br-Y, R	67	1651-1675	Br-Y, Bk
20	476-500	S-Y	44	1076-1100	S-Y, R	68	1676-1700	S-Y, Bk
21	501-525	Bl-V	45	1101-1125	Bl-V, R	69	1701-1725	Bl-V, Bk
22	526-550	O-V	46	1126-1150	O-V, R	70	1726-1750	O-V, Bk
23	551-575	G-V	47	1151-1175	G-V, R	71	1751-1775	G-V, Bk
24	576-600	Br-V	48	1176-1200	Br-V, R	72	1776-1800	Br-V, Bk

**SECTION 642-235-202CA**

**EXAMPLES**

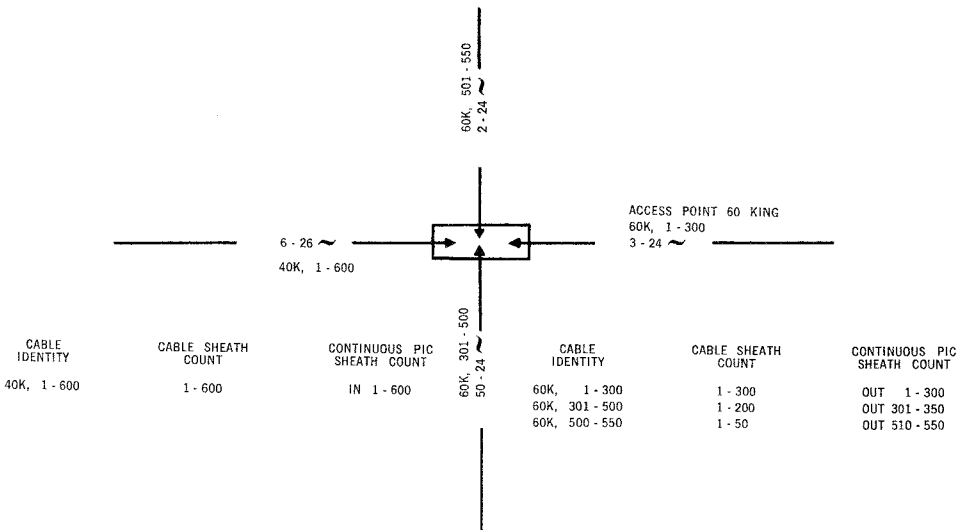
Examples of the application of the Continuous PIC Sheath Count method of identifying cable pairs in a control or access point are illustrated below:

**Example I**



In Example I there is one PIC cable entering the control point and one PIC cable leaving. It is not necessary in the case to re-identify any of the binder groups since the normal sheath count already corresponds to the Continuous PIC Sheath Count principle of one IN cable and one OUT cable, however cable unit markers should be placed.

**Example II**



In this case there is one IN cable and three OUT cables. It is still unnecessary to re-identify the binder groups of the IN cable since the cable sheath count already corresponds to the Continuous PIC Sheath Count principle. However, it is necessary to re-identify the ten binder groups in the 2-26 ~ and the 50-24 ~ OUT cables. When the groups are properly identified there appears to be only one OUT cable with 22 binder groups.

TABLE B illustrates the method of establishing the Continuous PIC Sheath Count by revising the binder groups.

TABLE B

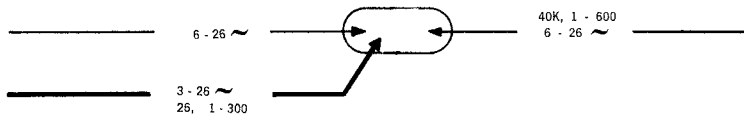
EXAMPLE OF ESTABLISHING CONTINUOUS PIC SHEATH COUNT  
IN A CONTROL OR ACCESS POINT

OUT CABLES				IN CABLES			
Cable PIC Sheath Count	Cable Binder Group	Continuous PIC Sheath Count	Unit Marker to use for Continuous Binder Group	Cable PIC Sheath Count	Cable Binder Group	Continuous PIC Sheath Count	Unit Marker to use for Continuous Binder Group
1-25	Bl-W	1-25	1	1-25	Bl-W	1-25	1
26-50	O-W	26-50	2	26-50	O-W	26-50	2
51-75	Gr-W	51-75	3	51-75	Gr-W	51-75	3
76-100	Br-W	76-100	4	76-100	Br-W	76-100	4
101-125	S-W	101-125	5	101-125	S-W	101-125	5
126-150	Bl-R	126-150	6	126-150	Bl-R	126-150	6
151-175	O-R	151-175	7	151-175	O-R	151-175	7
176-200	Gr-R	176-200	8	176-200	Gr-R	176-200	8
201-225	Br-R	201-225	9	201-225	Br-R	201-225	9
226-250	S-R	226-250	10	226-250	S-R	226-250	10
251-275	Bl-Bk	251-275	11	251-275	Bl-Bk	251-275	11
276-300	O-Bk	276-300	12	276-300	O-Bk	276-300	12
1-25	Bl-W	301-325	13	301-325	Gr-Bk	301-325	13
26-50	O-W	326-350	14	326-350	Br-Bk	326-350	14
51-75	Gr-W	351-375	15	351-375	S-Bk	351-375	15
76-100	Br-W	376-400	16	376-400	Bl-Y	376-400	16
101-125	S-W	401-425	17	401-425	O-Y	401-425	17
126-150	Bl-R	426-450	18	426-450	Gr-Y	426-450	18
151-175	O-R	451-475	19	451-475	Br-Y	451-475	19
176-200	Gr-R	476-500	20	476-500	S-Y	476-500	20
1-25	Bl-W	501-525	21	501-525	Bl-V	501-525	21
26-50	O-W	526-550	22	526-550	O-V	526-550	22
				551-575	Gr-V	551-575	23
				576-600	Br-V	576-600	24



**SECTION 642-235-202CA**

**Example III**



CABLE IDENTITY	CABLE SHEATH COUNT	CONTINUOUS PIC SHEATH COUNT	CABLE IDENTITY	CABLE SHEATH COUNT	CONTINUOUS PIC SHEATH COUNT
16, 601 - 800	1 - 600	IN 1 - 600	40K, 1 - 600	1 - 600	OUT 1 - 600
+ 25, 401 - 500	1 - 400	IN 601 - 1000			
+ 25, 1201 - 1500					
+ 26, 1 - 200					
+ D3001 - 3100					

In Example III a 3-26 ~ IN cable from the switching centre has been added. The 3-26 ~ will have to be re-identified and will join with the 6-26 ~ to form an IN cable with 40 binder groups — the OUT cables will be identified as in Example I.

**4. CABLE INSTALLATION**

**4.01** Whenever practicable, the IN cable from the switching centre side should enter on the left hand side as viewed from the front of the cabinet and the OUT cable enters on the right side. This method is not always possible thus the need for proper identification.

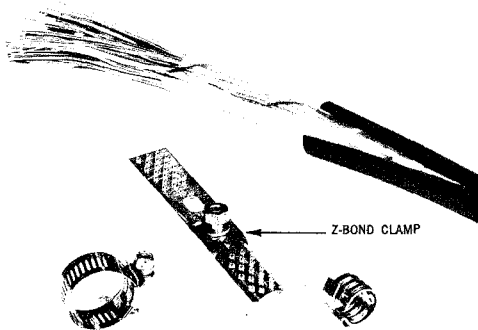
PIC SHEATH COUNT	TO CA. NO. COUNT	NO. OF PAIRS

**4.02 Cable End Locations**

- (a) QCH1C and QCH2C information on cable end location is not covered as those closures are now obsolete.
- (b) QTC12B and QCH11A. The cable should continue for 36 inches above the ground lug slots.
- (c) Clear and cap the IN cable using a Plastic Bag or Plastic Cap as outlined in Division 633 on Capping Cable Ends.

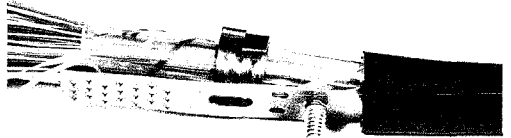
**Grounding Method**

- 4.03** Remove the cable sheath and aluminum shield  $\frac{3}{4}$  inch below the hole in the grounding bracket where the stud of the Z Bond Clamp will connect.
- 4.04** Measure a distance of 3 inches from the sheath opening and mark with B Paper Tape.
- 4.05** Using B Tabbing Shears cut one longitudinal slit *ONLY* in the outer sheath and aluminum shield up to the Paper Tape Marker on the opposite side of the cable to where the Z Bond Clamp is to be installed. (See Fig. 1).



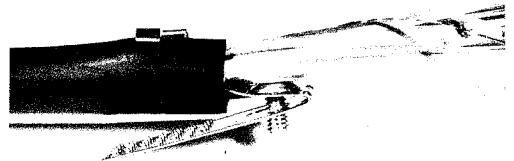
**Fig. 1 – Material & Slit**

- 4.06** Insert the whole curved portion of the Z Bond Clamp between the core wrap and the aluminum shield on the opposite side to the slit. (See Fig. 2).



**Fig. 2 – Z Bond Clamp Insertion**

- 4.07** Slide an Inner Sheath Clamp under the sheath until it is centered under the perforated portion of the Z Bond Clamp.
- 4.08** Fold back the exposed portion of the Z Bond Clamp, hinging it at the two holes near the stud. Lay the exposed end of the bonding

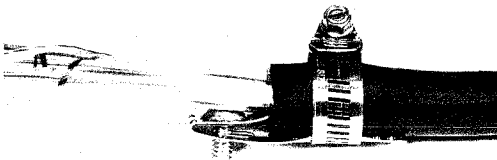


**Fig. 3 – Folded Bond Clamp and Inserted Inner Sheath Clamp**

## SECTION 642-235-202CA

clamp flat against the cable sheath engaging the stud into the slot. (See Fig. 3).

**4.09** Place a Sealing Clamp over the Sheath, Z Bond Clamp, and Inner Sheath Clamp so that the gearhousing of the Sealing Clamp is directly on top of the ears of the Inner Sheath Clamp. Tighten securely. (See Fig. 4).



**Fig. 4 — Bonding Arrangement Completed**

**4.10** Insert the stud of the Z Bond Clamp in the appropriate hole in the grounding bracket or tab and tighten securely using the lock nut provided.

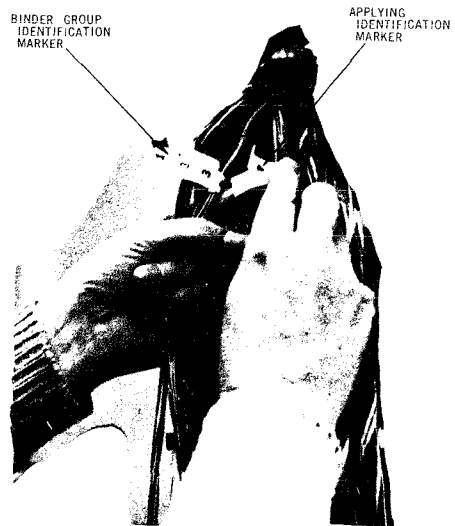
### 5. CABLE PREPARATION AND BINDER GROUP IDENTIFICATION

**5.01** To facilitate pair connection and identification in control and access points a continuous PIC Sheath Count will be established for all IN and OUT cables. This method is described in Part 3 of this practice.

**5.02** It will be necessary in many cases to mark the binder groups with a Unit Marker which differs from that normally associated with the cable sheath in accordance with the Continuous PIC Sheath Count Method.

**5.03** Identify the IN and OUT cables using the Dymo Tape Writer. The Dymo Tag should include the word IN or OUT according to the cables designation, plus the count of the cable.

**5.04** Before removing the unit binder, wrap each binder group of the IN and OUT cable or cables with the cable unit marker using the number that corresponds with the group, (e.g. Blue White = No. 1) unless a change is required to correspond to the Continuous PIC Sheath Count. Place the markers near the butt of the cable and near the end of the cleared or wrapped cable groups. (See Fig. 5)



**Fig. 5**

**5.05** The continuous PIC Sheath Count and Cable Unit Marker to use for binder group identification are listed in Table A.

### 6. CAPPING SPARE IN CABLES

**6.01** Clear the ends of the spare IN cable pairs using a Plastic Bag or Plastic Cap as described in Division 633 on Capping Cable Ends.

### 7. CONNECTING IN THE QCH1C

**7.01** The QCH1C is equipped with double channelling rings and distribution brackets as shown in Figs. 6 and 7.

**7.02** A maximum of 200 pairs (one IN + one OUT = 1 pair) may be connected at each channelling ring level (100 pr each side of the closure). This allows a maximum capacity of 600 OUT pairs for the QCH1C Closure.

**7.03 IN Cable:**

- (a) Place the IN cable from the switching centre side through the channelling rings on the left hand side as viewed from the front of the closure.
- (b) Clear and cap the IN cable using a Plastic Bag or Plastic Cap as outlined in Division 633 on Capping Cable Ends.

**7.04 OUT Cables:**

- (a) Route the OUT cable binder groups through the right hand channelling rings and lay across the top of the wiring brackets. The binder group colour codes must correspond to the colour code on the front of the distributing bracket.
- (b) Feed each 25 pair binder group through the back row of holes in the wiring bracket in accordance with the big number and pair count indicated on the front of the distributing bracket. (Figure 6).
- (c) Cut each binder group to a length of 12 to 15 inches below the bottom of the bracket to preserve the pair twist. Install a single wire tie near the end of the binder group.
- (d) Select a pair and pull from the single wire tie. Pull the pair taut, to remove any slack and cut the pair from 6 to 8 inches below the bottom of the distributing bracket.
- (e) Apply from four to six twists in the cable pair as close to the bottom of the wiring bracket as possible. This prevents splitting of the OUT pair.
- (f) Repeat (d) and (e) for each pair of the binder group and using the top of the next

lower distributing bracket as a guide, cut all pairs of the group. This assures a uniform length for the binder group. (Figure 11).

- (g) Secure the pairs in the binder group by wrapping with a single twist of wire to bind the group together.
- (h) Repeat procedures outlined in (c) through (f) for the remaining binder groups. Pairs through the lower bracket should be cut to the same length as the other pairs.
- (i) If a talk circuit is designated connect to the terminal block as described in part 12.
- (j) For lengthening conductors in IN and OUT cables proceed as described in Part 13.

**7.05 Connecting in the QCH1C:**

- (a) Select and cut the IN pair from the capped binder group.
- (b) Pull out the selected IN cable pair from the binder group immediately above the binder group marker at the sheath opening. Do not remove the selected pair from the binder group marker at the sheath opening. This prevents loss of identity.
- (c) Rerun the selected IN pair through the channelling rings in the space between the spare IN pairs and the connected IN pairs, to the appropriate splicing level. Care must be exercised to avoid tying in the pairs.
- (d) Pull the IN cable pair taut to remove slack and cut to the same length as the binder group containing the OUT cable pair.
- (e) Connect the IN cable pair to the OUT cable pair using B Wire Connectors. Do not remove the OUT pairs from the rear hole of the wiring bracket.
- (f) Repeat (a) through (e) to connect any additional IN cable pairs to OUT cable pairs.

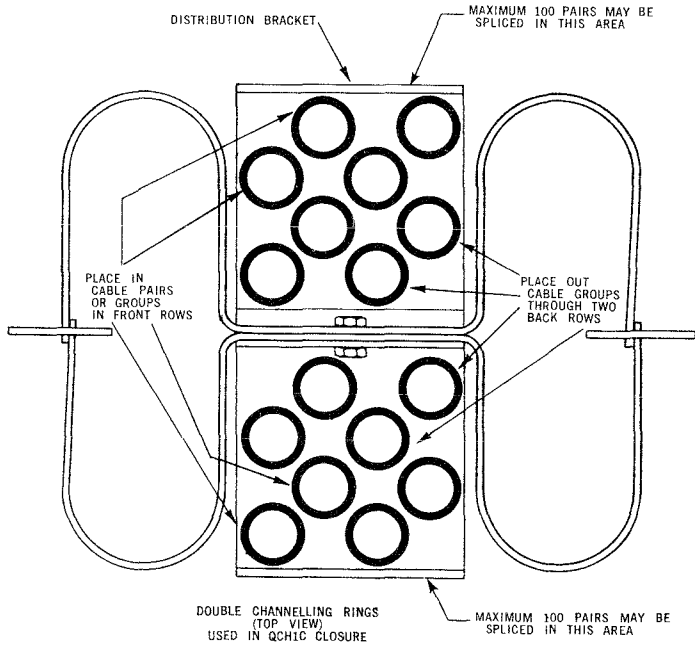
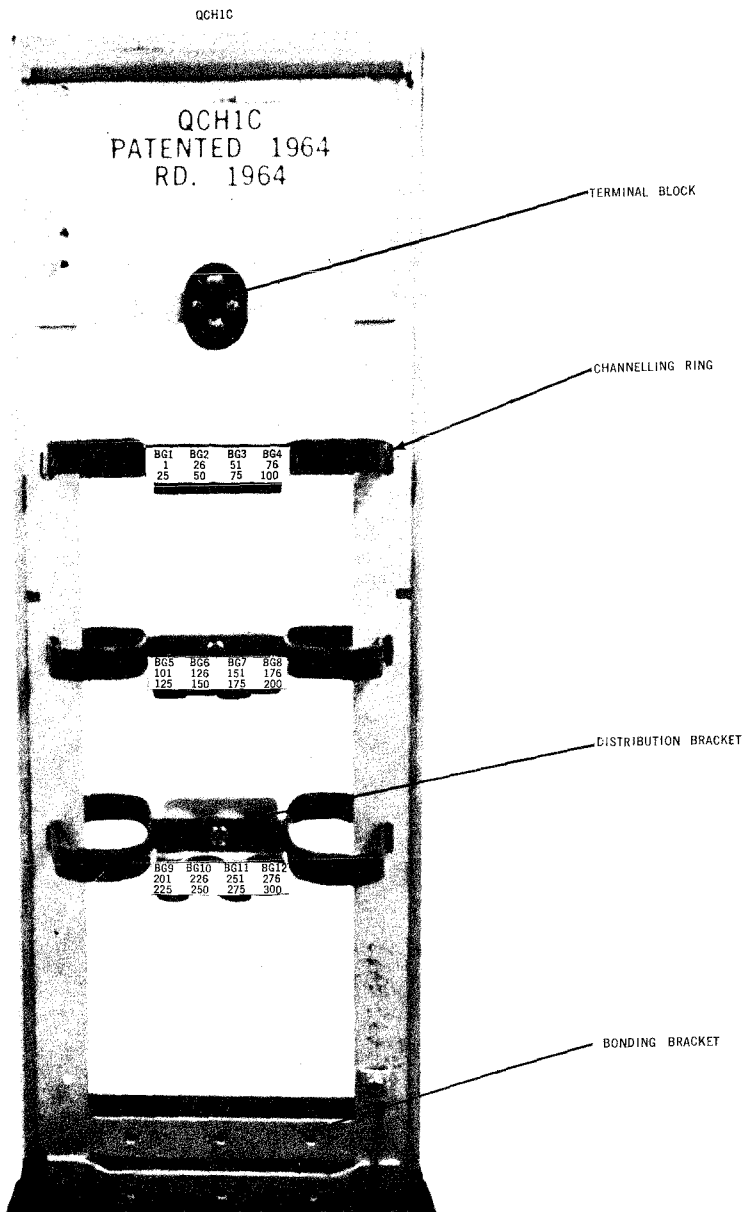
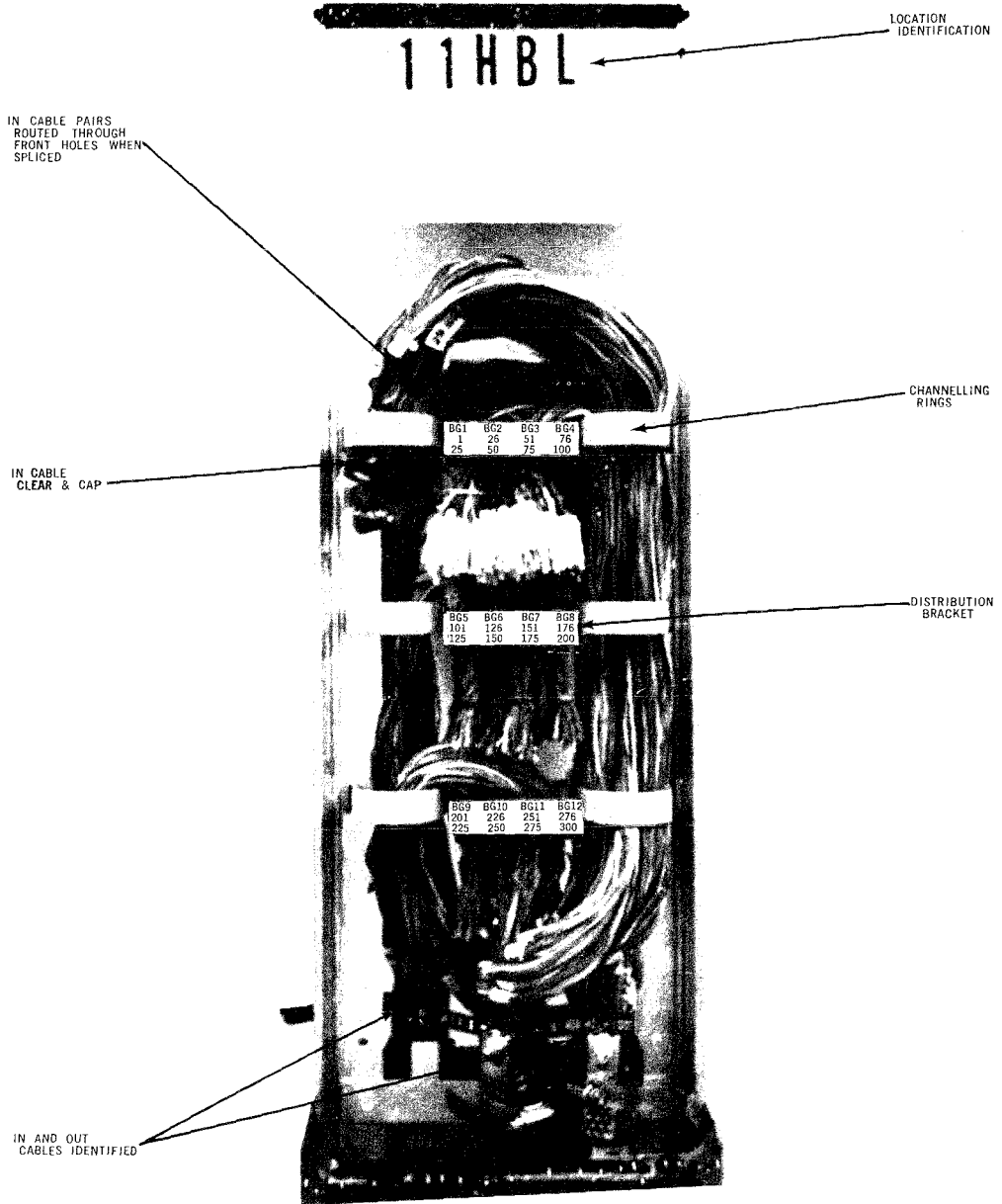


Fig. 6



QCH1C  
Fig. 7

SECTION 642-235-202CA



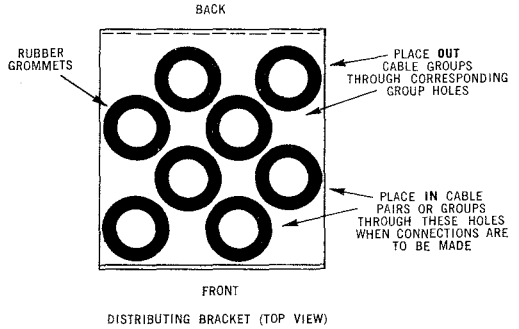
QCH1C  
Fig. 8

## 8. WIRING AND CONNECTING THE QCH2C

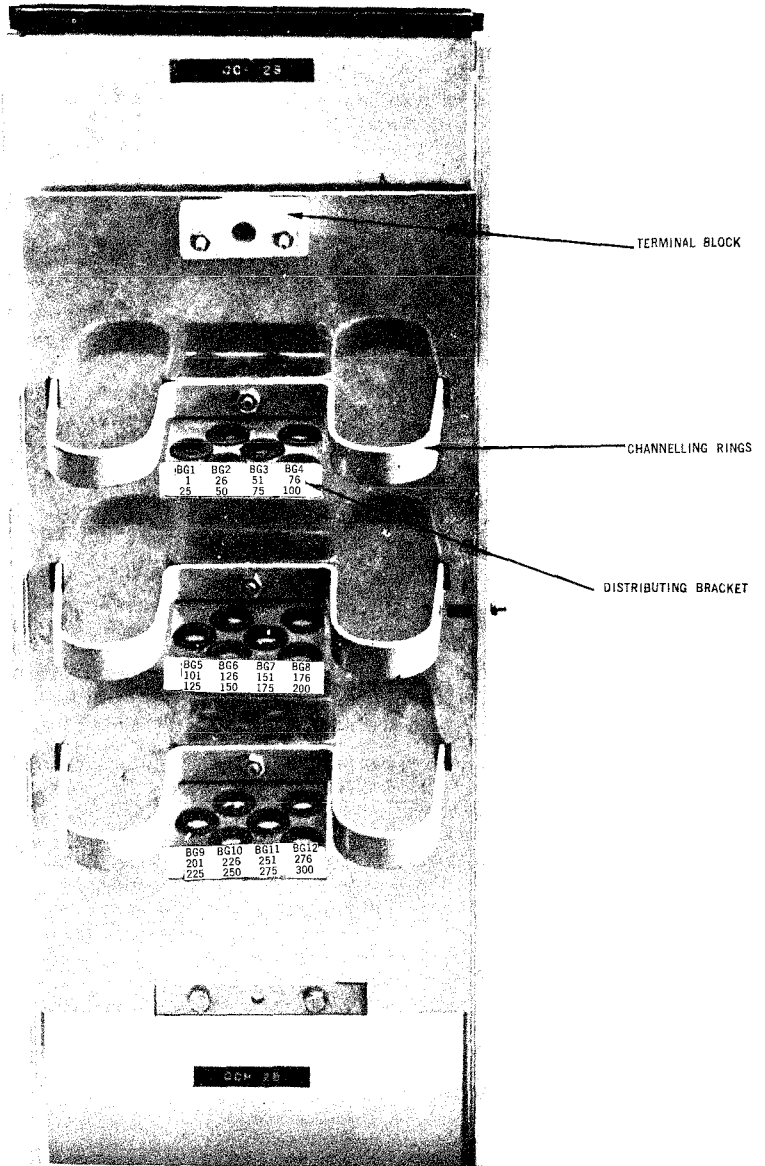
**8.01** The wiring and connection in the QCH2C closure which is used as an access point and may be used as a control point up to 300 "OUT" pairs is as described in Paras. 9.03 to 9.06.

**8.02** If a talk pair is designated connect to the terminal block as described in part 12.

**8.03** For lengthening conductors in IN and OUT cables proceed as described in part 13.







QCH2C  
Fig. 10

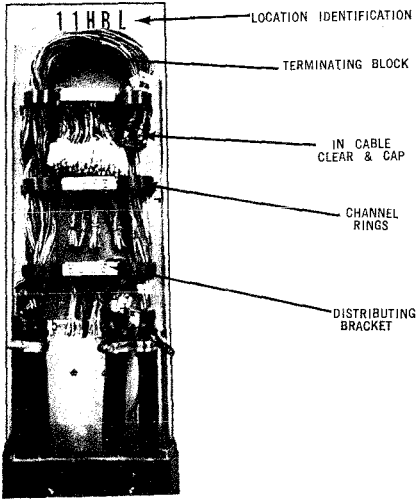


Fig. 11a

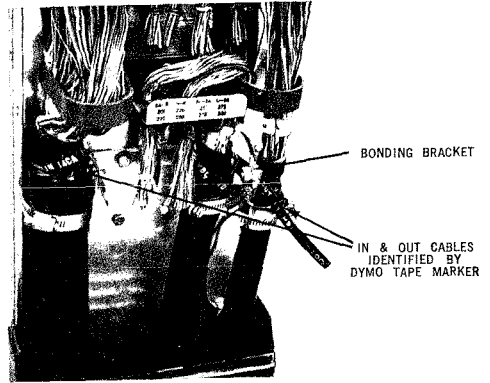


Fig. 11b

CUTTING THE 25-PAIR GROUP OF WIRES

Fig. 11

## SECTION 642-235-202CA

### 9. WIRING AND CONNECTING THE QCH12B

9.01 The wiring and connection in the QCH12B which may be used as a control or access point is as follows.

#### IN Cables

9.02 Place the IN cable from the wire centre through the channelling rings on the left hand side as viewed from the front of the closure.

9.03 Clear and cap the IN cable using a Plastic bag or Plastic Cap as outlined in Division 633 on Capping Cable Ends.

#### 9.04 OUT Cables:

(a) Route the OUT cable binder groups through the right hand channelling rings and lay across the top of the wiring brackets. The binder group colour codes must correspond to the colour code on the front of the distributing bracket.

(b) Feed each 25 pair binder group through the back row of holes in the wiring bracket in accordance with the B.G. number and pair count indicated on the front of the distributing bracket. (Figure 11).

(c) Cut each binder group to a length of 12 to 15 inches below the bottom of the bracket to preserve the pair twist. Install a single wire tie near the end of the binder group.

(d) Select a pair and pull from the single wire tie. Pull the pair taut, to remove any slack and cut the pair from 6 to 8 inches below the bottom of the distributing bracket.

(e) Apply from four to six twists in the cable pair as close to the bottom of the wiring bracket as possible. This prevents splitting of the OUT pair.

(f) Repeat (d) and (e) for each pair of the binder group and using the top of the next lower distributing bracket as a guide, cut all pairs of the group. This assures a uniform length for the binder group.

(g) Secure the pairs in the binder group by wrapping with a single twist of wire to bind the group together.

(h) Repeat procedures outlined in (c) through (f) for the remaining binder groups. Pairs through the lower bracket should be cut to the same length as the other pairs.

#### 9.05 Connecting in the QTC12B — 300 Out Pair Panel

(a) Select and cut the IN cable pair from the capped binder group.

(b) Pull out the selected IN cable pair from the binder group immediately above the binder group marker at the sheath opening. Do not remove the selected pair from the binder group marker at the sheath opening. This prevents loss of identity.

(c) Rerun the selected IN pair through the channelling rings in the space between the spare IN pairs and the connected IN pairs to the appropriate splicing level. Care must be exercised to avoid tying in the pairs.

(d) Pull the IN cable pair taut to remove slack and cut to the same length as the binder group containing the OUT cable pair.

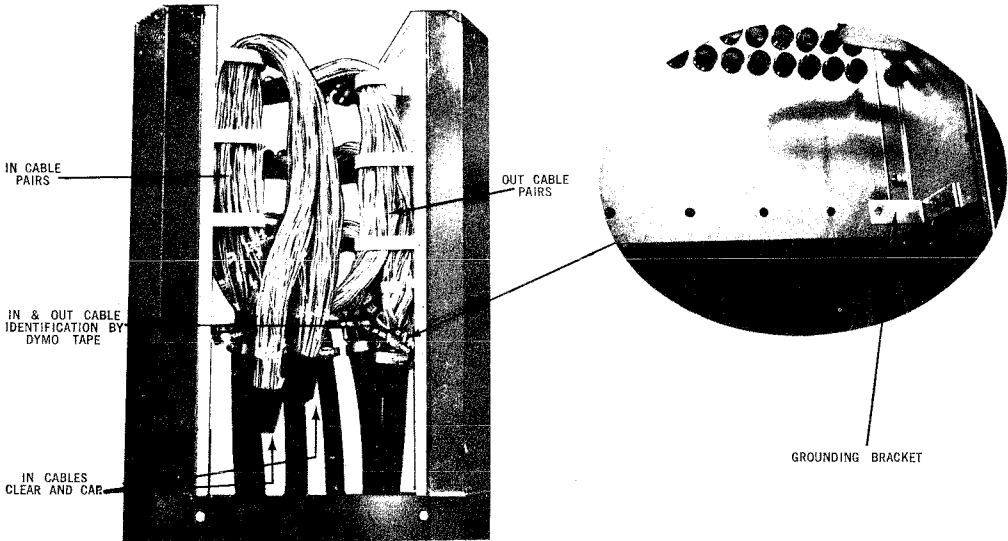


Fig. 12 — Cables Identified & Out Pairs in Place

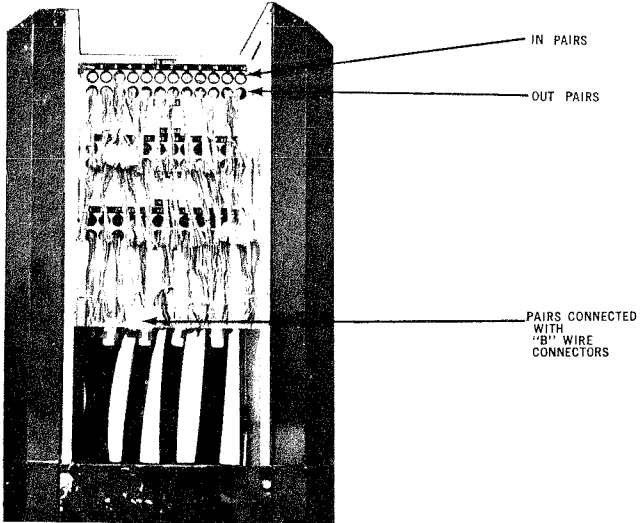


Fig. 13 — Front View Out & in Pairs Connected

## SECTION 642-235-202CA

(e) Connect the IN cable pair to the OUT cable pair using B Wire Connectors. Do not remove the OUT pairs from the rear hole of the wiring bracket.

(f) Repeat (a) through (e) to connect any additional IN cable pairs to OUT cable pairs.

### 9.06 IN Cables

(a) Route the IN cable up through the channelling rings on the left side of the terminal as viewed from the rear. (See Fig. 12)

(b) Clear the IN pairs as per Part 6 of this section.

### 9.07 OUT Cables

(a) There are three, double rows of distributing grommets. Counting from the left to the right on the pair connecting side (front) of the Control Point, these three double rows of grommets are identified by B.G. numbers respectively from top to bottom. Each single row has a capacity of 300 pairs. (See Fig. 13)

(b) Route the OUT cable binder groups up through the right hand channelling rings as viewed from the rear. Each 300 pair count or portion thereof should be layed over the channelling ring adjacent to its respective row of grommets. (See Fig. 12)

(c) Feed each 25 pair binder group through the bottom holes of the double row of grommets in accordance with the pair counts indicated on the front side of the panel. (See Fig. 13)

(d) Cut each group to a length of 12 to 15 inches below the row of grommets it passes through, to preserve the pair twist. Install a single wire tie near the free end of the binder group.

(e) Select a pair and pull from the single wire tie. Pull the pair taut to remove any slack and cut the pair 6 to 8 inches below the grommet.

(f) Apply 4 to 6 twists in the cable pair as close to the grommet as possible. This prevents splitting of the OUT pairs.

(g) Repeat (e) and (f) for each pair of the binder group and using a mark  $\frac{1}{2}$  inch below the next lower double row of grommets as a guide, cut all the pairs of the group. This assures a uniform length for the binder group. (See Fig. 13)

(h) Secure the pairs in the binder group by wrapping a single twist of wire to bind the group together.

(i) Repeat procedures outlined in (c) through to (h) for the remaining binder groups. Pairs through the lowest row of grommets should be cut to the same length as the other pairs.

### 9.08 Connecting in the QTC12B (900 pair panel)

(a) Select and cut IN cable pair from the capped binder group.

(b) Pull out the selected IN cable pair from the binder group immediately above the binder group marker at the sheath opening. Do not remove the selected pair from the binder group marker at the sheath opening. This prevents loss of identity.

(c) Rerun the selected IN pair through the channelling rings in the space between the spare IN pairs and the connected IN pairs to the appropriate splicing level. Care must be exercised to avoid tying in the pairs. (See Fig. 12)

(d) Place the IN cable pair through the top hole of the double row of grommets corresponding to the OUT cable pair.

(e) Pull the IN cable pair taut to remove slack and cut to the same length as the binder group containing the OUT cable pair.

(f) Connect the IN cable pair to the OUT cable pair using B Wire Connectors. Do not remove the OUT pairs from the bottom grommet. (See Fig. 13)

(g) Repeat (a) through (f) to connect any additional IN cable pairs to OUT cable pairs.

**10. VERIFICATION OF PAIRS COMMITTED (C.P. TO A.P.)**

**10.01** At time of committing pairs through a control point to feed an access point ONE PAIR in each 25 pair group (committed in whole or part) shall be tested between the control point and access point to ensure pair continuity and correct binder group sequence.

**11. IDENTIFYING SPECIAL CIRCUITS**

**11.01** When cable pairs are used for special services, it will be necessary to identify the circuits by wrapping a warning marker tape around each B Wire Connector.

**12. TALKING CIRCUIT**

**12.01** If a talking circuit is designated connect to the terminal block as follows:

**12.02** Cut the assigned talk pair from the capped binder group.

**12.03** Strip the insulation from the ends of the talk pair and terminate by wrapping the wires around the binding post of the terminal block and tighten the nuts.

**13. LENGTHENING PAIRS****OUT Cable Pairs**

**13.01** If an OUT cable pair is too short, lengthen the conductors as follows:

(a) Obtain a length of wire having the same coloured insulation and gauge as the cable pair to be lengthened.

(b) Cut the ends of the OUT cable conductors and lengthened conductors square, insert a B Wire Connector and press.

(c) Route the lengthened wires through the distributing ring and place through the assigned rear hole of the wiring bracket and apply four to six tight twists to prevent pair splitting.

**IN Cable Pairs**

**13.02** IN cable pairs which have been disconnected from OUT pairs or cut from the cleared and capped end and are not to be used immediately must be cleared and dressed as described below:

(a) Lengthen the pair as described in Para. 13.01 ((a) and (b)).

(b) Route the wires through the distributing lines along with the remaining IN spare pairs of the same binder group.

(c) Cut the pair the same length as the rest of the IN spare pairs.

(d) Clear the ends of the pair by placing a "B" Wire Connector on each wire.

(e) Tape the wires to their respective binder group, near the cleared end of the IN pair stub.



VEHICLE OPERATORS DRIVING INSTRUCTIONS AND PRECAUTIONS  
 SPECIFIC CASES REQUIRING SPECIAL CARE  
 PARKING INSTRUCTIONS — SKIDDING

	CONTENTS	PAGE
1.	GENERAL . . . . .	621
2.	RAILWAY CROSSINGS . . . . .	621
3.	TROLLEY CARS . . . . .	622
4.	GRADES . . . . .	622
5.	OTHER HAZARDS . . . . .	622
	<i>Passing Vehicles</i> . . . . .	622
	<i>Intersections</i> . . . . .	623
	<i>Curves and Turns</i> . . . . .	623
	<i>Through Highways and Through Streets</i> . . . . .	624
	<i>Insufficient Clearance</i> . . . . .	624
	<i>Bicycles</i> . . . . .	624
	<i>Pedestrians</i> . . . . .	624
	<i>Livestock</i> . . . . .	624
	<i>Stinging Insects</i> . . . . .	624
	<i>Winter Conditions</i> . . . . .	624
6.	PARKING . . . . .	625
7.	SKIDDING . . . . .	629
8.	USE OF SLOW MOVING VEHICLE SIGN . . . . .	629

1. GENERAL

1.01 This section covers driving instructions and precautions relating to specific cases requiring special care. It is reissued to add Part 8, "Use of Slow Moving Vehicle Sign".

1.02 Section 720-100-900 covers starting up, getting under way and other general considerations.

2. RAILWAY CROSSINGS

2.01 At all railroad crossings, when weather or road conditions are bad, the windows frosted or misted or if the vehicle's engine is noisy, take the necessary precautions to be sure all is clear before proceeding. Lower the windows or, if practical, stop and open the right door to see and hear if it is safe to cross the tracks. If the view along the tracks is obscured or obstructed and the driver is not alone, the passenger should be sent to the crossing to signal the driver if the way is clear. If the driver is alone, he should approach the tracks with extreme caution and be prepared to stop when necessary. When stopping at any railroad crossing be sure to signal following traffic. Stay on the right side of the road and in line with traffic. At double tracks or multi-track crossings, be sure a second train is not approaching on another track after the first train has passed. Do not change gears while crossing the tracks.

2.02 *Unprotected Crossings:* Bring the vehicle to a stop at a safe distance from the crossing. Make sure all is clear before proceeding. At crossings where there are two or more sets of tracks, unless the view from the first stopping point is completely unobstructed and providing there is sufficient space between the tracks to permit safely stopping the vehicle clear of all tracks, another stop should be made and a second look taken before crossing each additional set of tracks.



## SECTION 720-100-901CA

**2.03 Protected Crossings:** At crossings protected by gates, light signals or watchman, slow down to 20 miles per hour or such lower speed as may be necessary due to the condition of the crossing. Approach protected crossings cautiously. Electrical or mechanical devices have been known to fail and watchmen are subject to human error.

**2.04** When crossing the tracks, ALLOW SUFFICIENT SPACE FROM THE VEHICLE AHEAD SO THAT IF THE DRIVER STOPS YOU WILL NOT BE BLOCKED ON THE TRACKS.

### 3. TROLLEY CARS

**3.01** Observe municipal regulations regarding stopping for trolley cars. Except where the tracks are at the right of the road or in one-way streets, pass to the right of trolley cars.

**3.02** Where pedestrians have left the curb at car stop ahead, be very careful. Sound the horn. Slow down and, if necessary, stop.

**3.03** On streets where trolley cars operate, drive so as not to obstruct trolley car traffic and on signal from the motorman, drive off the tracks as soon as practical.

**3.04** When overtaking a trolley car which is approaching a switch or curve, be sure that the car cannot strike your vehicle in passing. Intersections where approaching trolley cars are likely to turn left across your path are also hazardous.

**3.05** When passing a trolley car which is proceeding in the opposite direction, watch for pedestrians who may step from behind it.

### 4. GRADES

**4.01** Before descending a steep grade with a heavily loaded vehicle, or in any vehicle when the condition of the road does not offer good traction, change to a lower gear, keep the clutch engaged so as to take advantage of the engine drag and to reduce the tendency of the rear wheels stopping. Keep the vehicle speed low by

an intermittent and careful application of the brakes. If a skid starts release the brakes at once and when skidding has stopped try the brakes again very carefully. In extreme cases, if other braking fails, turn off the ignition. With an automatic transmission set the selector in the "low" range.

**4.02** Before climbing a steep grade with a heavily loaded vehicle, shift to a lower gear and try to avoid shifting on the grade. Most passenger cars and light commercial vehicles will climb fairly steep grades in high gear. If it appears the vehicle will not make the grade in high, shift to the next lower gear, preferably before the speed has dropped to 20 miles per hour.

With an automatic transmission no change in selector setting is required on passenger cars or light commercial vehicles. On heavily loaded vehicles the selector should be moved to the "low" range.

**4.03** If you stop or the engine stalls when climbing a grade proceed as follows: disengage the clutch and apply the foot brake to prevent the vehicle rolling backward; set the parking brake to hold; start the engine with the clutch still disengaged; shift to low gear; accelerate the engine to a higher speed than normally required and engage the clutch slowly at the same time releasing the parking brake as the clutch begins to engage.

**4.04** On hills, do not pass vehicles travelling in the same direction. Stay in your own lane on the right side of the road.

**4.05** Avoid fast driving over the crest of a hill.

### 5. OTHER HAZARDS

#### Passing Vehicles

**5.01** In driving past parked vehicles be on the alert for pedestrians who may step out from between them and for vehicles that may pull out from the curb.

**5.02** Before passing a vehicle travelling in the same direction, assure yourself that there is ample road width and clear length ahead and

that there is sufficient margin of speed available to pass quickly. Sound the horn, signal the traffic behind, and turn out at a safe distance from the other vehicle. If in doubt, drop back into line. After passing do not cut in or slow down too soon.

**5.03** Do not pass in any of the following cases:-

- (a) In approaching or on a curve,
- (b) Where solid painted lines or other markings indicate that passing is prohibited,
- (c) At intersections or railroad crossings,
- (d) On a hill or near the crown of a hill,
- (e) Under any unsafe conditions.
- (f) - (1) In Ontario when a school bus is stopped on a two lane or divided highway for the purpose of receiving or discharging school children, where the median strip is less than 10 feet wide and the maximum speed is greater than 35 miles per hour, the driver of a vehicle shall, when overtaking a school bus on which the words "do not pass" when signals are flashing are marked and two red signal lights are illuminated by intermittent flashes; and when meeting on such a highway, other than a highway with a median strip greater than 10 feet wide, the driver must bring the vehicle to a full stop and shall not proceed until the school bus resumes motion or the signal lights are no longer operating.

On a divided highway if the median strip is 10 feet wide or over, you are not required to stop when meeting a school bus.

- (f) - (2) In Quebec — When a motor vehicle overtakes or meets an autobus used in transporting school children, duly identified as such, which is stationary to take on or discharge school children, the driver of such vehicle shall not pass or drive beyond such autobus until it is again put in motion; nor shall he do so until the children have boarded the autobus, or have left it and reached the side of the road.

**Note:** Be alert for road signs or markings on school buses that may indicate different local

or municipal regulations in towns, cities, villages, etc.

- 5.04** Be alert for signals from other drivers who may wish to pass. Where necessary, give other drivers more than their fair share of the road. Keep well to the right and slow down as required. Do not attempt to increase speed of your vehicle to prevent others from passing.

#### **Intersections**

- 5.05** Slow down in approaching intersections. Observe signal lights or stop signs where present. Observe any marked stop line or, if none, do not enter the nearest crosswalk or pass the line of intersection of the road surfaces. Vehicles on your right have the right-of-way, but vehicles on your left are still a hazard. In any case give the other vehicle the right-of-way if it will avoid an accident.

- 5.06** Be on the alert for drivers approaching the intersection from the opposite direction who may wish to make a left turn across your path.

- 5.07** When windows tend to be frosted, in mist or heavy rain, be watchful for approaching traffic on side streets or roads. Lower the windows to see when necessary. Keeping a window open to provide ventilation will help reduce mist or frost on windows. If windshield vision becomes obstructed, stop the vehicle.

- 5.08** Where a "yield right-of-way" sign has been erected at the entrance to an intersection, the driver or operator of a vehicle approaching a "yield right-of-way" sign shall slow down to a speed reasonable for the existing conditions, or shall stop if necessary and shall yield the right-of-way to traffic in the intersection or approaching on the intersecting highway so closely that it constitutes an immediate hazard, and having so yielded may proceed with caution.

- 5.09** Pass driveway entrances carefully as many are partly hidden and view of traffic on the drive cannot be obtained.

#### **Curves and Turns**

- 5.10** Slow down for curves and turns. Give signal to following drivers well in advance

## SECTION 720-100-901CA

and use rear view mirror to make sure signal is not disregarded. Keep some traction on the wheels to avoid skidding.

**5.11** In making right turns keep to the right of the road. Observe municipal ordinances regarding left turns. In approaching a corner for a left turn, keep the left side of the vehicle as close as practical to the centre of the roadway except in one-way streets.

**5.12** Avoid turning around in the centre of a block. Turn at the next corner or drive around the block.

### Through Highways and Through Streets

**5.13** Stop before entering through roadways. Give traffic on such roadways the right of way. Stop before entering or crossing such roadways from a private lane or driveway and give traffic the right-of-way.

**5.14** Slow down and drive cautiously at bridges and underpasses. Be on the alert for any of the following hazards.

- (a) The roadway narrows, or is curved, rough or not level.
- (b) The road surface is wet and the air temperature is below freezing (32°). A bridge surface will ice up before a road surface due to air circulation under the bridge.
- (c) Vision is obscured by the bridge or underpass structure.

### Insufficient Clearance

**5.15** Stop if there is any doubt about having sufficient clearance from another vehicle or a low bridge or an underpass.

### Bicycles

**5.16** Give cyclists plenty of room when passing them but keep out of the path of approaching vehicles.

### Pedestrians

**5.17** Avoid crowding pedestrians. Give them the right of way. In stopping, do so at a sufficient distance so that your intention will be

clear. Be particularly considerate of aged and infirm people and of children. Don't confuse them by using the horn unnecessarily. Drive cautiously and slowly when children are playing on or near the roadway, when they are stealing rides or hitching on to the vehicle ahead, and in the vicinity of schools, school crossings and playgrounds.

### Livestock

**5.18** When livestock are on or beside the roadway, slow down to a low rate of speed so that the vehicle can be promptly stopped should an animal stray out in front. In passing through a herd of cattle, a slow steady speed in low gear is often effective, the engine hum easing the cattle out of the way.

### Stinging Insects

**5.19** If bees, wasps, or other stinging insects get in the windows and are flying around in the vehicle, it is usually best to pull over to the side and stop to deal with them.

### Winter Conditions

**5.20** Fogging or frosting of the vehicle windows is a general winter condition. Do not attempt to drive until the windshield and rear windows have been cleared sufficiently to allow safe vision. If the side windows are not clear, do not take chances, lower the windows enough so that you can see sufficient of the road for safety.

**5.21** *Ice:* When starting on ice, packed snow or other slippery surface power must be used sparingly to prevent the rear wheels from spinning. If a start cannot be made in low gear try intermediate or high, engage the clutch very slowly and above all do not race the engine.

In stopping allow ample room. Try the brakes tentatively while still some distance away as a check. As a rule several short gentle applications of the brakes, with the clutch engaged, will slow the vehicle without skidding, and of course the vehicle speed must be kept down to suit the conditions. (See Part 7).

**5.22** *Chains:* Tire chains are sometimes necessary in deep snow and for climbing icy hills. For stopping on icy roads their value is un-

certain. The brakes must be applied with as great care with chains, to avoid skids, as without them. (See Section 720-100-010).

**5.23** Dual brake systems (separate systems front and rear) were introduced on all passenger cars and light trucks in 1967 and may be identified by a brake warning light on the dash of the vehicle.

The purpose of a dual brake system is that if one system fails it does not impair the operation of the other brake system and the operator will be able to bring the vehicle to a controlled stop.

(a) A system failure will be indicated by illumination of the dash mounted warning light and a marked increase in effort to apply brakes and increase in pedal travel upon applying the brakes. The warning light bulb should be checked frequently by turning the ignition switch to the "ON" or "START" position with the parking brake engaged.

(b) In case of a failure of one system the following braking technique will apply:

(1) Providing that the road surface is dry the operator should apply and hold firm pressure on the brake pedal.

(2) On wet, snow covered or icy pavement the operator should bring the vehicle to a stop by applying only sufficient effort on the brake pedal to bring the vehicle to a controlled stop to prevent skidding.

## 6. PARKING

**6.01** *Municipal Areas:* Where practical, park on side streets rather than busy main streets. Before pulling a vehicle over to park, signal so that following drivers will know your intentions. When parking parallel to the roadway be sure not to park too close to other vehicles. This will assure you, and the other vehicle drivers, sufficient space to manoeuvre the vehicles out of the parking space. When parking at an angle to the roadway be sure that the vehicle, and the equipment or load on vehicle, does not project so as to interfere with vehicular traffic or pedestrians. If the vehicle and the equipment or load on the vehicle does project, park elsewhere. In all cases avoid obstructing or creating hazards to traffic and pedestrians.

### 6.02 *Local Ordinances and Parking Positions:*

Local Ordinances on parking shall be observed. If, however, you are unaware of these ordinances, in any particular area, the following will serve as a guide until Local Ordinances can be learned.

(a) The curbside wheels must be within 6 inches from the edge of the roadway or curb when parking parallel to the roadway. When parking at an angle to the roadway the near wheel of the vehicle must be at the edge of the roadway or against the curb. Where parking spaces are lined for parallel or angle parking, the vehicle will be parked within the lines.

(b) A vehicle shall not be parked in any of the following places.

Within 30 feet of the curb line of an intersecting street.

Within 120 feet of the curb line of an intersecting street where there are public transportation system stops.

Within 25 feet of the driveway entrance to any fire station on the side of the street on which the fire station is located, or within 100 feet of the fire station entrance on the opposite side of the street.

Within a 15 foot radius of a fire hydrant.

Within a 20 foot radius of any street excavation or obstruction.

Within 40 feet of any public transportation system stop sign when it is in the middle of a block.

Within 30 feet on either side of the prolongation of the curb lines at "T" street intersections.

Within 120 feet of the curb line of a cross street, at places where there are automatic signal detectors.

In front of a school, theatre, church, or other public assembly hall, when such establishments are occupied, or in front of a lane or private driveway entrance.

Within 100 feet of a railway crossing, bridge or subway approach.

**6.03** *Highways:* Vehicles shall not be parked or left standing, whether attended or unattended, upon any highway in such a manner as to

## SECTION 720-100-901CA

interfere with the movement of other traffic or clearing of snow from such highway. Where practical, park off the well travelled portion of the highway and where the vehicle can be clearly seen from both directions. Avoid curves, corners, and the top and bottom of hills. If necessary to park on the well travelled portion of the roadway for any reason, it is the sole responsibility of the person in charge to take all necessary precautions to warn approaching traffic.

**6.04 Stopping and Parking After Dusk:** From one half hour after sunset to one half hour before sunrise vehicle lights are required. Stopping or parking on highways outside of business and residential areas, during these hours, should be only by reason of absolute necessity. If possible, the vehicle should be parked well off the travelled portion of the road. If the vehicle operator must stop as part of his work assignment, he should be equipped with adequate warning devices as outlined in the 620-135-100 Plant Series.

Ontario and Quebec laws require that "commercial vehicles", travelling on highways outside of cities, towns or villages during the hours when lights are required, must carry approved flares, lamps, lanterns, or portable reflectors. Company owned commercial vehicles are equipped with either portable reflectors or kerosene flares which meet provincial requirements. Although our passenger cars are not licensed as commercial vehicles they are equipped with portable reflectors (commencing in 1964). Commercial vehicles which usually work within the municipal boundaries of Toronto and Montreal are not equipped with these warning devices, however, if an occasion arises in which such a vehicle will be driven on highways outside the municipal boundaries during the time when vehicle lighting is required, portable reflectors, which can be procured at a tool pool centre, must be carried. See Catalogue of Supplies, Section 3, under Flare, Reflector, Flip-up.

The general rules for use of the approved warning devices and other precautionary measures intended to conform to the laws of both provinces are outlined as follows:

- (a) If it is necessary to stop, the vehicle should be moved off the pavement or the travelled portion of the road, if possible, and parking

lights should be left on. If the vehicle is equipped to flash all four turn signals simultaneously, the four way flasher should be turned on.

- (b) If the vehicle is disabled, it should be moved off the pavement or off the travelled portion of the road, if possible, and the parking lights (and flashers if any) should be left on as in (a) above. The warning devices referred to above are to be used also. In Ontario and in the case of all passenger cars, they are to be prepared for use and placed at points approximately 100 feet ahead of and behind the vehicle on a line approximately parallel to the edge of the road and even with the side of the vehicle nearest the traffic. For Company vehicles, other than passenger cars in the Province of Quebec, three flare units are required and they are to be positioned on the road as shown in the following figure. In severe snow storms, or under other weather conditions warranting it, the warning devices will require special attention so that they will produce their warning. Under such conditions the vehicle should be left unattended, only if assistance cannot otherwise be attained.

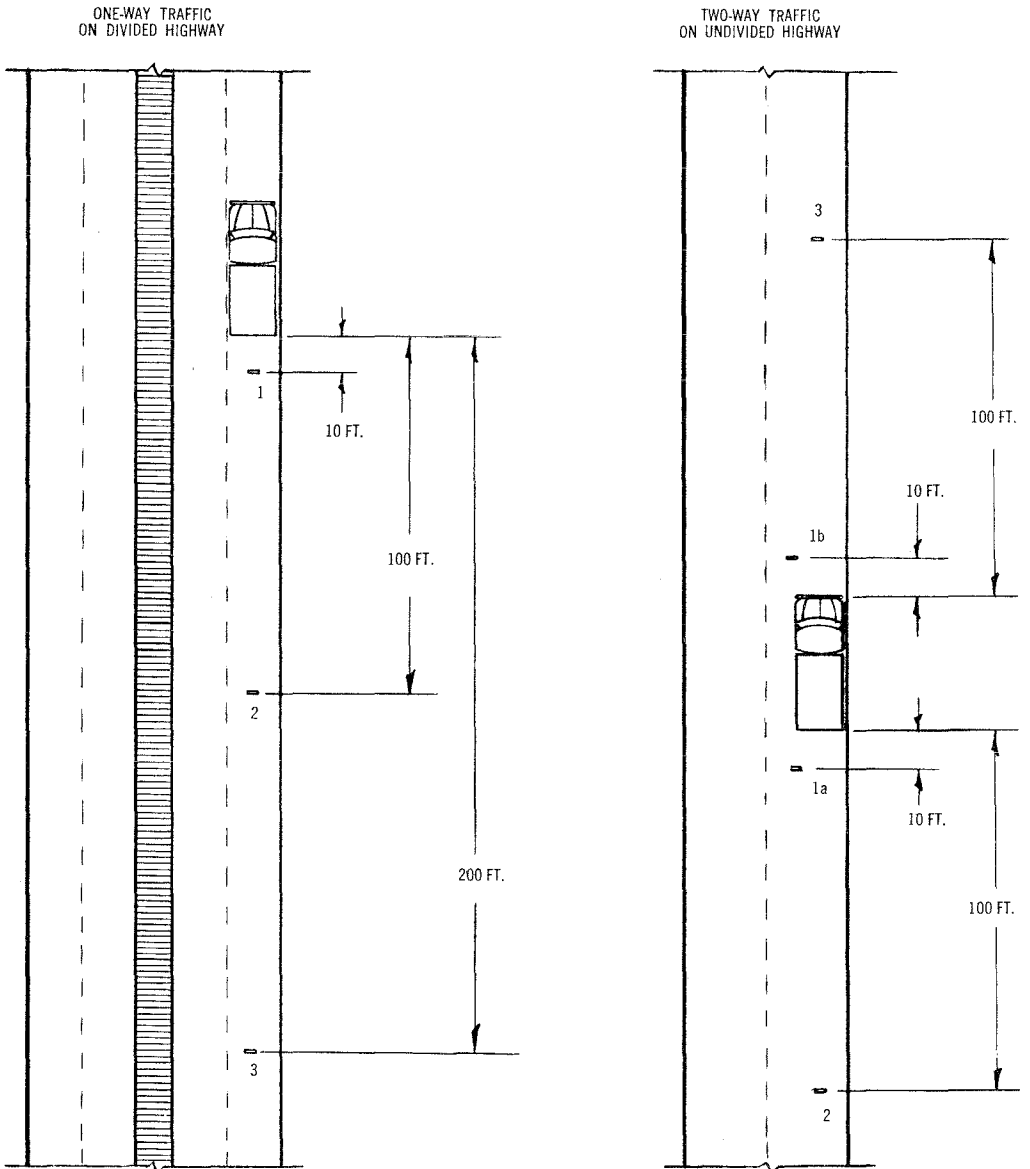
### **6.05 Parallel Parking on Roads with Curbs:—**

- (a) On an Up-Grade — Drive up alongside the curb, cut the front wheels fully away from the curb and carefully allow the vehicle to roll back until the right front wheel rests against the curb. Firmly apply the hand-brake and shift the transmission to reverse gear (Indicator to "Park" with automatic transmission).
- (b) On Down-Grades — Drive up along-side, and about 4 inches from the curb, cut the front wheels fully into the curb and allow the vehicle to roll into the curb slowly until the vehicle has come to a stop. Firmly apply the handbrake and shift the transmission to reverse gear (Indicator to "Park" with automatic transmission).
- (c) On Level Ground — Drive up alongside the curb and firmly apply the handbrake. Shift the transmission to reverse gear (Indicator to "Park" with automatic transmission).

### **6.06 Angle Parking on Roads with Curbs:—**

- (a) On an up-Grade — This type of parking must be avoided if at all possible, particu-

REQUIRED POSITIONS FOR THREE FLARES OR PORTABLE REFLECTORS ON QUEBEC HIGHWAYS



NOTE: Either position 1a or 1b may be used depending on which is better, considering road bends, vehicle position, etc.

## SECTION 720-100-901CA

larly with trucks. It is preferable, because of the length of the vehicle, the possible projection of the vehicle load or equipment, the weight of the vehicle and the hazards associated with backing from the parking space, to drive to another location where parallel parking is permitted. If it is found necessary to angle park on an up-grade, drive or back the vehicle into the parking space, as required by Local Ordinance, until a wheel is resting against the curb, firmly apply the handbrake and shift the transmission to reverse gear (Indicator to "Park" with automatic transmission). Block at least one of the rear wheels if the vehicle is nosed into the parking space, as the curb cannot be utilized to help hold the vehicle.

(b) On a Down-Grade — This type of parking must be avoided with large trucks, as the length of the vehicle and the possible projection of the load or equipment will interfere with vehicle traffic and/or pedestrians. If such is the case, drive to where parallel parking is permitted. If the vehicle can be angle-parked without obstructing traffic or pedestrians, drive into the parking space until the right front wheel rests against the curb. Firmly apply the handbrake and shift the transmission to reverse gear (Indicator to "Park" with automatic transmission).

(c) On Level Ground — Drive into the parking space until the right front wheel rests against the curb. Firmly apply the handbrake and shift the transmission to reverse gear (Indicator to "Park" with automatic transmission).

### 6.07 *Parking on Grades without Curbs:*

Parallel and Angle Parking — Parking on grades without curbs must be avoided with vehicles of all types if at all possible. Should it be found necessary to park on such roads, the procedure as outlined above for the particular type of parking contemplated, should be followed. At least one of the rear wheels shall be blocked with a wheel chock or similar object on the down-grade side to act in lieu of a curb.

### 6.08 *Special considerations when Parking:*

(a) Handbrake — If weather conditions are such that there is a danger of the hand-

brake freezing on, block at least one of the rear wheels on the down-grade side with a wheel chock or similar object. The use of wheel chocks is outlined in Section 649-040-200.

(b) Two Speed Differentials — Vehicles equipped with a two speed differential shall, at all times, be parked with the differential in the "Low" range. The shift to "Low" range must be made while the vehicle is still in motion or the gears may fail to engage. If a vehicle with a two-speed differential is parked with the differential in "High" range, it is possible on some vehicles, that on shutting down the vehicle's engine, causing engine vacuum to drop, the differential will shift out of "High" range and into "Neutral". This would result in a neutral drive line, and no holding power from the vehicle's engine or handbrake.

(c) Automatic Transmissions — The transmission indicator of a vehicle equipped with an automatic transmission must never be placed at "Park" while the vehicle is in motion, doing so will almost certainly strip the parking gear. For this reason it is advisable to apply the handbrake before placing the Indicator at "Park". It will be noted, in some cases, that the transmission indicator will have to be placed at "Neutral" before the vehicle's engine can be started.

(d) Mico Lever Lock Model 8800. The Mico lever lock is designed solely to be used for holding the vehicle during work operations, e.g. winching or digging. It must not be used as a parking brake as any minute leak in the hydraulic system would cause the brake lock to release. Care should be exercised in setting the brake lock when brake drums are hot. If high temperatures exist in the brake drums when the brake lock is applied, drum damage can result from the increased pressures built up within the drum due to contraction on cooling. Drivers should be instructed to exert only reasonable brake pedal pressure when setting the brake lock.

6.09 *Leaving Vehicle in Safe Condition:*— Before leaving a vehicle unattended make sure that it is in a safe condition. Engine must be shut off, all windows closed, all doors locked, and key removed.

- 6.10 In winter, avoid parking below a sloping roof.
- 6.11 Avoid parking on sloped ground with the vehicle top tilting toward passing traffic.
- 6.12 When leaving the vehicle, wherever practical get down at the curb side. If, for any reason it is found necessary to get down at the traffic side, check to be sure no traffic is approaching before opening the door. Open the door slowly, observing for cyclists, etc. all the while.
- 6.13 A vehicle should not be doubled parked. It ties up traffic and is frequently the cause of accidents.
- 6.14 Avoid parking on streets which have been extremely narrowed by snow banks or on which snow removal is in progress.

## 7. SKIDDING

- 7.01 The word skid as applicable to an automotive vehicle may be defined as a sidewise movement not planned by the driver. Its prime cause is a combination of a lessened grip of the tire on the road coupled with some sidewise force that is greater than the tire's grip. A skid may result in a partial or total loss of control of the vehicle by the driver.
- 7.02 Safe operation of a vehicle cannot be accomplished unless the driver always has complete control of direction and speed. It has been established that rolling tires have steering ability, while sliding tires do not. The reason for this is that there is a much greater inherent road gripping power in a rolling tire than in a sliding tire.
- 7.03 When a skid starts, that is when the driver gets the first impression or sensation that he is losing control of the vehicle, he must think and act quickly. The seriousness of the resulting effects of a skid depends not only on the driver's speed of reaction but also on his knowledge of what to do under the circumstances in which he finds himself.
- 7.04 In most skidding situations the driver can regain control by releasing the accelerator (which causes the braking action of the engine to slow down the vehicle) and turning the front wheels in the direction of the skid. Use of the brakes is not recommended because of the danger of locking the rear wheels, thereby only aggravating the skidding condition.
- 7.05 If the driver feels that these actions are not producing the desired effect of gaining control or if the driver's first impression is that a bad skid (flat spin) is developing, as well as performing the above steps he should proceed further to disengage the clutch and try to control the speed by pumping (fanning) the brakes. Under very slippery conditions the braking action of the engine may be sufficient to cause one rear wheel to lock. By disengaging the clutch the braking action of the engine is released from the rear wheels which will then be free to start rolling, thereby increasing their grip on the road and reducing the skidding action of the rear end of the vehicle. The slowing down of the vehicle now may only be attained by using the brakes. The driver is advised to concentrate on the pumping action of the brakes and avoid allowing the wheels to lock.
- 7.06 The release of the clutch and resultant use of the brakes, although apparently contradictory to the procedure recommended for most skids, is beneficial where under certain very slippery road surfaces the braking action of the engine with the accelerator released but the clutch engaged would produce a premature slowing down of the rear wheels almost as serious as locking the brakes.

## 8. USE OF SLOW MOVING VEHICLE SIGN

- 8.01 The slow moving vehicle sign is a fluorescent yellow-orange triangle with a dark red reflective border designed for display by slow moving vehicles.
- 8.02 This sign is required by law in both Ontario and Quebec but under slightly different conditions as described below.
- 8.03 In Ontario, this sign is intended as a unique identification of slow moving vehicles such as farm tractors and backhoes. It is not re-



## SECTION 720-100-901CA

commended for use on trucks or other vehicles which can travel at highway speeds.

**8.04** In Quebec, this sign is required on all vehicles or combination of vehicles of which the normal highway speed is 25 mph or less. This includes farm tractors as well as highway vehicles travelling at 25 mph or less to perform their work (e.g., Telsta). Although the sign is not recommended for vehicles travelling at over 25 mph, it may be left on the vehicle when travelling for short distances between work locations.

**8.05** The slow moving vehicle sign is for use during daylight or at night. It supplements but does not replace other warning devices which may already be required. It should not be displayed by vehicles parked along public highways

or travelling at more than 25 mph (except as noted in Para. 8.04.)

**8.06** This sign should be mounted base down in a plane perpendicular to the direction of travel, at the rear of the vehicle as close as possible to the centre. The base should be at a height of 3 to 5 feet above the roadway. It is the responsibility of the Automotive Equipment Group to install a suitable bracket on those vehicles which have a normal highway speed of 25 mph or less. On vehicles which have a normal highway speed of over 25 mph but which may have to travel at less than 25 mph to perform their work it is the responsibility of the using group to request the Automotive Equipment Group to install a suitable bracket.

## ADMINISTRATIVE INFORMATION

### EQUIPMENT AND MATERIAL

The responsibility for maintaining the correct vehicle load of telephone sets and material is with the craftsman. He shall keep a tally of sets used each day so that replacements may be ordered each evening in accordance with local administrative procedures. This usage shall be noted on the Supplies Order Form.

When the vehicle leaves the work centre at the opening of business each day, the full complement of telephone sets as indicated on the B.T. Form 3213 shall be on the vehicle.

At times, due to unforeseen circumstances, this load may result in occasional shortages.

To request equipment by telephone from the Supplies distribution centre for use today, the following steps should be followed:

- (1) State your name
- (2) State your reporting centre (i.e., work centre)
- (3) Material required
- (4) Account Code being worked on — (e.g., 28C(R)–28C(B))
- (5) Address of job location requiring this equipment
- (6) State reason for taxi delivery
- (7) State telephone number (if working)
- (8) State if required on urgent basis.

Telephone number to reach you

(Job location  
or Control  
Centre)

### HANDSETS

**FUNCTION** For persons with impaired hearing, volume control equipment increases the volume of the receiver.

#### USOC

<b>VLN</b>	Impaired Hearing Feature. Rotary Switch on Handset. All standard colours and black.	G6AR G6AQ1A 501-210- 300CA
------------	---	-------------------------------------

<b>AMP</b>	Volume control Receiver Feature. Turn button in base of set— Black only — non key tel.	532 type set 502-520- 402CA
------------	--	-----------------------------------

<b>AMU</b>	Volume Control Receiver Feature External Key — Magneto areas only	6030A Key 512-215- 100CA
------------	---	--------------------------------

<b>ATM</b>	Volume Control Headset feature for Attendants use	153A or 153B Amp- plifiers 981-280-100
------------	---	---

**FUNCTION** For persons who wish to speak in a low voice, volume control equipment increases volume of transmitter.

#### USOC

<b>HVS</b>	Confidential Handset Feature, Rotary switch in handset All standard colours and black.	G7AQ1A Handset 501-210- 300CA
------------	--	--

**FUNCTION** For persons who have difficulty in using a telephone in a noisy location.

#### USOC

<b>HCF</b>	Noisy location transmitter feature — Special transmitter improves reception. Available in Green, Beige, Grey, Ivory and Black.	Noise cancelling Transmitter NS-16664 Confidencer 500-126- 100CA
------------	--	---

#### USOC

<b>TCH</b>	Noisy Location Transmitter Cut-off Feature Press to talk switch in handset reduces background noise. Available in Black only.	G2GRN G5GRQ1A Handset 501-210- 300CA
------------	---	--

<b>TCT</b>	Noisy location transmitter foot cut-off feature. Foot operated switch reduces background noise.	Switch foot NS16821L1 030-760-701
------------	---	---

See also Apparatus for use at Noisy Locations.  
B.S.P. 500-126-100CA

### UNIFORM SERVICE ORDER CODES

The following list provides a ready reference for the most frequently used Uniform Service Order Codes. It is divided into two sections:

Section 1 — Class of Service Codes and the Account Codes chargeable

Section 2 — Uniform Service Order Codes, with corresponding word descriptions, most frequently used on Service Orders

Refer to the Master Reference List available in the Control Centre and/or Appendix A to V64.5 10 for additional codes and instructions.

#### CLASS OF SERVICE CODE

USOC	DESCRIPTION	ACCOUNT CODE
1 FB	Bus Ind Tel Sys	28
1 FBKS	Bus Key Sys	28
1 FBPB	Bus Push Button Sys	28
1 FL	Bus Ind Line Sys	28
1 FR	Res Ind Tel Sys	28
1 FRKS	Res Key Sys	28
1 FRPB	Res Push-Button Sys	28
1 FW	Res Ind Line Sys	28
1 MB	Bus Ind Tel Sys Message Rate	28
1 ML	Bus Ind Line Sys Message Rate	28
1 OF	Official Ind Tel Sys	28
1 OFKS	Official Serv Key Sys	28
1 OFPB	Official Serv Push-Button Sys	28
1 OL	Official Ind Line Sys	28
1 PC	Public Ind Tel Sys	28
1 PN	Public Toll Tel Sys	28
1 SP	Semi-Public Ind Tel Sys	28
2 FB	Bus 2 Party Tel Sys	28
2 FL	Bus 2 Party Line Sys	28
2 FR	Res 2 Party Tel Sys	28
2 FW	Res 2 Party Line Sys	28
7 HT	Public Multi-Party Tel Sys	28
7 HU	Public Multi-Party Tel Sys Cust Attended	28
8 FB	Bus Multi-Party Tel Sys	28

USOC	DESCRIPTION	ACCOUNT CODE
8 FL	Bus Multi-Party Line Sys	28
8 FR	Res Multi-Party Tel Sys	28
8 SP	Semi-Public Multi-Party Tel Sys	28
PFG	Public Toll Tel Sys Non-Comm	28
AFB1X	Bus PBX Sys 506A	28
AFB2X	Bus " " 507B	28
AFB3X	Bus PBX Sys 550	28
AFB4X	" " " 551	28
AFB5X	" " " 555	28
AFB6X	" " " 605A	58
AFB7X	" " " 750A	28
AFB8X	Bus PBX Sys 755A	28
AFB9X	" " " SE1	28
AFBAX	" " " 740AX	58
AFBBX	" " " 740A	28
AFBCX	" " " 756A	28
AFBDX	Bus PBX Sys 701S	58
AFBEX	" " " 701	58
AFBAB	" " Answer Board Sys	28
AFBJX	Bus PBX Sys 900	58
AFBCO	Centrex I Sys CO	58
AFBCU	Centrex I Sys CU	58
AFBGX	Bus PBX Auto Call Dist Sys 40	28
AFBHX	Bus PBX Auto Call Dist Sys 200	58
AFBOT	" " Order Turret Sys	28
AFR1X	Res PBX Sys 506	28
AFR2X	Res PBX Sys 507B	28
AFR3X	" " " 550	28
AFR4X	" " " 551	28
AFR5X	" " " 555	28
AFR7X	" " " 750A	28
AFR8X	Res PBX Sys 755A	28
AFR9X	" " " SE1	28
AFRCX	" " " 756A	28
AOF1X	Official PBX Sys 506A	28
AOF2X	" " " 507B	28

USOC DESCRIPTION ACCOUNT CODE

AOF3X	Official PBX Sys	550	28
AOF4X	" " "	551	28
AOF5X	" " "	555	28
AOF6X	" " "	605A	58
AOF7X	" " "	750A	28
AOF8X	Official PBX Sys	755A	28
AOF9X	" " "	SE1	28
AOFAX	" " "	740AX	58
AOFBX	" " "	740A	58
AOFXC	" " "	756A	28
AOFDX	Official PBX Sys	701A	58
AOFEX	" " "	701	58
AOFCO	" Centrex I Sys	CO	58
AOFCU	" " "	CU	58

USOC WORD DESCRIPTION

1LPB1	Qtr Mi Loc Comm Intercom Circuit
1LPGA	Qtr Mi Priv Line Circuit
1LQBB	Connection to Answer Serv
1LTB1	Qtr Mi Loc Comm Tie Trunk Circuit
1LUB1	Qtr Mi Loc Comm Telephoto Chan
1LVB1	Qtr Mi Loc Comm Data Chan 4
1LWC1	Circuit Between Bldgs
1LXX1	Qtr Mi Extra Each Mileage
1MB	Bus Individual Tel Message Rate
1MBKX	Bus Individual Key Tel Message Rate
1ML	Bus Individual Line Message Rate
1OF	Official Individual Tel
1OFET	Official Individual Tel
1OFKX	Official Individual Key Tel
1OFOL	Official Individual Tel Out Only

SECTION 2

UNIFORM SERVICE ORDER CODES

USOC WORD DESCRIPTION

1FB	Bus Ind Tel
1FBKX	Bus Ind Key Tel
1FG	Trunk Line — Bus or Res
1FH	Trunk Line Comb — Bus or Res
1FJ	Trunk Line In — Bus or Res
1FK	Trunk Line Out — Bus or Res
1FL	Bus Ind Line
1FLOL	Bus Ind Line Out Only
1FR	Res Ind Tel
1FRKX	Res Ind Key Tel
1FW	Res Ind Line
1L1BB	Wired Music Circuit
1L3BA	Sig Chan B Duplex
1L3BB	Sig Chan B
1L6BA	Data Chan 1 Duplex
1L6BB	Data Chan 1
1LABA	Sig Chan A Duplex
1LABB	Sig Chan A
1LHG4	Mi Foreign Exch Mileage
1LJBA	Data Chan 2 Duplex
1LJBB	Data Chan 2
1LLB1	Qtr Mi Loc Comm Off Prem Circuit
1LMB1	Qtr Mi Loc Comm Sig Chan C
1LNBA	Data Chan 3 Duplex
1LNBB	Data Chan 3

1QL	Official Individual Line
1PC	Public Individual Tel
1PCPN	Public Individual Panel Tel TT
1PCWM	Public Individual Tel
1PD	Panel Single Slot Feature
1PN	Public Toll Tel
1SP	Semi Public Individual Tel
238	Paging Sys Low Power Spkr-Amplifier
239	Paging Sys Amplifier
23B	Paging Sys High Output Spkr
23L	Paging Sys Microphone
27L	PB Priv Line Termination Illum
27M	PB Priv Line Termination Non Illum
29G	Intercom Circuit
29H	Intercom Circuit
2FB	Bus 2 Party Tel
2FBKX	Bus 2 Party Key Tel
2FL	Bus 2 Party Line
2FR	Res 2 Party Tel
2FRKX	Res 2 Party Key Tel
2FW	Res 2 Party Line
2MF	Double Drop Wire Serv
2MH	Double Drop-Specific Term
312	Attendant Lightweight Headset
3CM	13 Ft Cord
3SB	Bell 3 Inch Low Volt
44L	Common Equip 740AX
44M	Common Equip 701
45T	Common Equip 711
45U	Common Equip 711
46Z	Tie Trunk Term In & Out Dial & Sel

## USOC WORD DESCRIPTION

489 Tie Trunk IX Auto Ringing Ftr  
 48A Tie Trunk Term In Dial & Sel  
 48B Tie Trunk Tandem Ftr  
 4NB Coml Bell 4 Inch & Sig Control  
 4TB Coml Bell 4 Inch  
  
 4VB Bell 4 Inch Low Volt  
 55K Rapidial Auto Dialer  
 599 Attendant Headset Trans Cut-Off  
 5AS Attendant 15 Ft Spring Cord  
 5BZ No 7 Bell  
  
 67Q Wired Music Distributing Amplifier  
 67R Bunching Block Arrangement  
  
 7HT Public Multi Party Tel  
 7HU Public Multi Party Cust-Attend Serv  
  
 8AS Attendant 10 Ft Spring Cord  
 8FB Bus Multi Party Tel  
 8FL Bus Multi Party Line  
 8FN Toll Tel  
 8FR Res Multi Party Tel  
  
 8JQ Sign 143  
 8JT Sign 141  
 8JV Sign 139  
 8JZ Sign 145A  
 8SP Semi Public Multi-Party Tel  
  
 8VQ Public Individual Tel One-Way  
 8VQWM Public Individual Tel One-Way  
 (WMTD)  
 9AL Shelf A  
 9AV Table A  
 9AX Priv Line Equip  
 9CM 9 Ft Cord  
 9DL PBX Tel  
 9DLKX PBX Key Tel  
 9LZ Intercom Termination 4A Key  
  
 AAR Answering & Recording Equip  
 AFH Adl Res Individual Tel  
 AMF Vol Control Close Talk Trans Ftr  
 AMG Vol Control Dist Talk Trans Ftr  
 AMN Bone Conduction Receiver  
 AMP Vol Control Receiver Ftr  
 AMU Vol Control Receiver Ftr External  
 ANN Public Ind Tel One-Way — Non Comm  
 ATB Attendant Pushbutton Tel 507B  
 ATC Attendant Headset 53A

## USOC WORD DESCRIPTION

ATH Attendant Headset 52A  
 ATM Vol Control Headset Ftr  
 ATN Attendant Headset  
 ATS Attendant Chestset  
 ATT Attendant Hand Combined Tel  
  
 ATW Attendant Handset  
 ATX Attendant Headset 52A  
 ATY Attendant Headset 53A  
 ATZ Attendant Chestset  
 BBC Bus Interphone Console  
  
 BBL Bus Interphone Console Large  
 BBM Bus Interphone Tel Ftr  
 BBS Bus Interphone Console Small  
 BEC Bell Chime  
 BFY Bell Vibrating  
  
 BFZ Chime  
 BGG Horn  
 BGGCC Code Call Horn  
 BGH Bell Vibrating Outdoor  
 BGJ Chime Outdoor  
  
 BGJCC Code Call Chime Outdoor  
 BGN Horn Outdoor  
 BGNCC Code Call Horn Outdoor  
 BKF Bell Regulator Feature  
 BL4 Coml Bell 10 Inch & Sig Control  
  
 BL6 Coml Bell 6 Inch & Sig Control  
 BL7 Coml Bell 10 Inch & Sig Control  
 BLD Coml Bell 10 Inch  
 BLE Coml Bell 10 Inch Outdoor  
 BLG Bell Explos Atmos  
  
 BLL Bell 6 Inch Low Volt  
 BUT Sig Button  
 BUZ Buzzer  
 BZZ Buzzer Low Volt  
 CAK Antique or Decorator Ftr  
  
 CAU Alarm Coupler  
 CAW Antique or Decorator Ftr-Modified  
 CAWER Antique or Decorator Ftr-Ericofon  
 CB7 Bus Interphone TT Selection Ftr  
 CBA Bus Interphone Common Equip 3  
  
 CBD Bus Interphone Common Equip 6  
 CBE Bus Interphone Common Equip 9  
 CBG Bus Interphone Common Equip 12  
 CBJ Bus Interphone Common Equip 18  
 CF9 Hwy Sign

## USOC WORD DESCRIPTION

CFT Code-a-phone  
 CLR Colour Tel Ftr  
 CLT Bus Extra Listing  
 CMV Pedestal Coin  
 CNA Contempra  
  
 CNB Booth 11  
 CP9 Walk Up Unit  
 CQ9 Hwy Directional Sign  
 CQB Sign 142  
 CQQ Sign 107 W  
  
 CQR Sign 118 W  
 CQU Sign 118 Y  
 CS8 Coin Box Table  
 CT2 Booth Airlite Indoor  
 CT7 Table D  
  
 CT8 Drive Up Unit  
 CT9 Shelf E  
 CTB Booth 5  
 CTE Booth 6  
 CTP Telephone Bth  
 CTR Booth Acrylic Outdoor  
 CTW Booth 9AGN  
 CTX Booth 9BGN  
 CTY Booth Airlite Outdoor  
 CUB Shelf 19A  
 CUT Cut-Off Ftr  
  
 CUX Directory Shelf 11  
 CV2 Sign 136E  
 CV2FX Sign 136F  
 CV3 Sign 137E  
 CV3FX Sign 137F  
  
 CV4 Sign 120W  
 CV5 Sign 129  
 CV6 Sign 130  
 CV7 Sign 135  
 CV9 Hwy 500 Ft Sign  
  
 CVY Sign 126W  
 CW4 Sign 144A  
 CWB Sign 146  
 CWE Sign NU2C  
 CWF Sign 145B  
  
 CWG Sign 147A  
 CWJ Sign 147B  
 CWS Sign 140  
 CY6 Telecart  
 CYG Sign 144B — Directional

## USOC WORD DESCRIPTION

DAA Dial Intercom Remote Relay  
 DAM Link Intercom Add-On Ftr Line Equip  
 DAU Dial Intercom Adl Dial Code  
 DCD Dictating Attendant Line  
 DCT Dictating Term  
  
 DD9 Link Intercom Circuit  
 DE8 Dictating Term 755A  
 DJE Attendant Handset  
 DLV Dial Intercom Circuit  
 DLY Link Intercom Adl Dial Code  
  
 DSY Link Intercom Add-On  
 ELN PBX Restricted Line  
 EM2 Emerg Report Outdoor Tel  
 EMM Emerg Report Ext Tel  
 EMN Emerg Report Weatherproof Cabinet  
  
 EMY Emerg Report Individual Tel  
 ET9 Pedestal  
 EX2 Ext Bell Loud Outdoor  
 EXB Ext Bell  
 EXG Ext Bell Loud  
  
 EXL Ext Line  
 EXT Ext Tel  
 EXTKX Ext Key Tel  
 FJ3 Bell Single Stroke  
 FJ3CC Code Call Bell  
  
 FJ6 Bell Single Stroke Outdoor  
 FJ6CC Code Call Bell Outdoor  
 FLT Extra Listing  
 FMP Bus Interphone-F Init Equip  
 FMQ Bus Interphone-F Monitor Spkr-Mike  
  
 FMR Bus Interphone-F Desk Spkr-Mike  
 FMT Bus Interphone-F Adl Equip  
 FMU Bus Interphone-F Horn Spkr-Mike  
 FNU Bus Interphone-F Tone Ringer  
 GUB Home Interphone Spkr  
  
 H3G TWX 33 Page Send Receive  
 H3GAC TWX 33 Auto Code Converter  
 H66 Weatherproof Tel Ftr  
 HAH Hanger 9A  
 HC2 Explos Atmos Tel Ftr  
  
 HC4 Explos Atmos Tel Ftr  
 HC7 Vol Control Trans Ftr  
 HCD Elevator Tel Ftr  
 HCF Noisy Location Trans Ftr  
 HCG Explos Atmos Tel Ftr

## USOC WORD DESCRIPTION

HCJ Weatherproof Wall Tel Ftr  
 HCP Portable Main Tel Ftr  
  
 HDH Public Ext Tel No Dial  
 HDK Guest Room One Digit Dial Term  
 HGK PBX Line  
 HGL PBX Ext Tel  
  
 HGLKX PBX Ext Key Tel  
 HGM PBX Restricted Ext Tel  
 HGMKX PBX Restricted Ext Key Tel  
 HJH Home Interphone Trans  
 HLD Line Hold Button  
  
 HMR Home Interphone Adl Equip Door Ans  
 HMS Home Interphone Init Equip  
 HMT Home Interphone Adl Equip  
 HMV Home Interphone Init Equip Door Ans  
 HNA Coml Horn  
  
 HNB Coml Horn Outdoor  
 HNN Coml Horn & Sig Control  
 HNT Coml Horn Outdoor & Sig Control  
 HQU Coin Collector PBX Tel  
 HUS Voice Silencer Tel Ftr  
  
 HVS Confidential Handset Ftr  
 JK8 Portable Tel Jack 755A  
 JKH 4A Key Equip With Hold Ftr  
 JKS Jack  
 JKT Weatherproof Jack  
  
 JKW 4A Key Equip  
 KD3 Call Director  
 KD3FX Call Director 30 Button Flush Mtd  
 KD4FX Call Director 60 Button Flush Mtd  
 KDBFX PB Call Director 60 Button  
  
 KDL PB Call Director 30 Button  
 KDLFX PB Call Director 30 Button  
 KDS PB Call Director 18 Button  
 KDSFX PB Call Director 18 Button  
 KEX Intercom Tel  
  
 KEXKX Intercom Key Tel  
 KKL PB Line Ftr Non-Illum  
 KKQ PB Line Ftr Illum  
 KLM Pushbutton Illum  
 KT2 PB Res Tel Pick-Up Ftr  
  
 KT8 PB Tel Ftrs Non-Illum  
 KTT PB Bus Interphone Tel Ftrs  
 KTV PB Bus Interphone Console Small  
 KTY PB Bus Interphone Console Large  
 KTZ PB Tel Ftrs Illum

## USOC WORD DESCRIPTION

KUV Call Director Jack  
 LDF Night Light Ftr  
 LP2 Double Lamp External  
 LP3 Triple Lamp External  
 LP4 Small Lens Lamp 3  
  
 LP5 Small Lens Lamp 3 Flush Mtd  
 LP6 Small Lens Lamp 4  
 LP7 Single Lamp External  
 LPL Red Bull's Eye Lamp  
 LPN Incoming Line Lamp  
  
 LQL Dome Lamp  
 LRL Lantern Lamp Outdoor  
 MW6 Message Waiting Tel Ftr  
 MWE Message Waiting Common Equip  
 N91 Individual Night Service  
  
 N92 Tks To One PBX Tel Night Serv  
 N93 Tk Ans Any Tel Night Serv  
 NC3 Night Cord 3 Way  
 NC4 Night Cord 4 Way  
 NC5 Night Cord 5 Way  
  
 NCB Bridged Night Number  
 NKE PBX Night Answer Tel  
 NPU Non Published Service  
 NTS PB Intercom Termination Non-Illum  
 NTT PB Auto Intercom Signalling  
  
 NTZ Apt Interphone Intercom Tel  
 NUX PB Intercom Termination Illum  
 OBA Bus Interphone Answering Handset  
 OBF Bus Interphone Dial Selection Ftr  
 OBP Bus Interphone Adl Desk Spkr  
  
 OBPFX Bus Interphone Adl Horn Spkr  
 OBQ Bus Interphone Group Address Ftr  
 OBS Bus Interphone Sectl Transfer Ftr  
 OBT Bus Interphone Adl Talk Path  
 P35 PBX Ext Line  
  
 P38 Common Equip 740A  
 P8D Attendant Console 4A  
 P9A PBX Telephone  
 P9AKX PBX Key Telephone  
 P9B PBX Line  
  
 P9C PBX Extension Telephone  
 P9CKX PBX Extension Key Telephone  
 P9D Attendant Console 50A  
 P9J PBX Restricted Telephone  
 P9JKX PBX Restricted Key Telephone

## USOC WORD DESCRIPTION

P9L PBX Restricted Extension Tel  
 P9LKX PBX Restricted Ext Key Tel  
 P9R PBX Restricted Line  
 P9V P9V PBX Extension Line  
 PA5 Switchboard 507B  
  
 PB2 Switchboard 555 120 Line  
 PB4 Switchboard 551A  
 PB4A4 Switchboard 550 40 Line  
 PB5 Switchboard 551B Over 80 Line  
 PB5A0 Switchboard 550 Over 80 Line  
  
 PB6 Switchboard 555 60 Line  
 PB8 Switchboard 551B 80 Line  
 PB8A8 Switchboard 550 80 Line  
 PCG Switchboard 551D  
 PD3 Common Equip 750A  
  
 PEK Switchboard 556A  
 PF4 Common Equip SE1  
 PF5 Attendant Console 701A  
 PF6 Attendant Cabinet 740A  
 PF7 Attendant Console 3A  
  
 PKU Line Pick Up Button  
 PL8 Noisy Location Tel Ftr  
 PR9 Common Equipment 900  
 PRN Princess Tel Ftr  
 PRZ PBX Ext Tel  
  
 PSW PBX Ext Line  
 PSZ PBX Restricted Ext Line  
 PT2 Priv Line Tel  
 PT2KX Priv Line Key Tel  
 PT4 Common Equip 755A  
  
 PTV PBX Restricted Ext Tel  
 PVZ PBX Ext Tel  
 PVZKX PBX Ext Key Tel  
 PW3 PBX Restricted Line  
 PW5 PBX Tel  
  
 PW5KX PBX Key Tel  
 PW8 PBX Line  
 PWA PBX Tel  
 PWB PBX Restricted Tel  
 PWD PBX Line  
  
 PX2 PBX Tel  
 PX2KX PBX Key Tel  
 PX3 PBX Line  
 PX4 PBX Ext Tel  
 PX4KX PBX Ext Key Tel

## USOC WORD DESCRIPTION

PX6 PBX Tel  
 PX6KX PBX Key Tel  
 PX7 PBX Line  
 PX8 PBX Ext Tel  
 PX8KX PBX Ext Key Tel  
  
 PXA PBX Tel  
 PXAKX PBX Key Tel  
 PXB PBX Line  
 PXC PBX Ext Tel  
 PXCKX PBX Ext Key Tel  
  
 PXD PBX Restricted Tel  
 PXDKX PBX Restricted Key Tel  
 PXE PBX Restricted Line  
 PXF PBX Restricted Ext Tel  
 PXFKX PBX Restricted Ext Key Tel  
  
 PXG PBX Restricted Ext Line  
 PXJ PBX Restricted Tel  
 PXJKX PBX Restricted Key Tel  
 PXL PBX Restricted Ext Tel  
 PXLKX PBX Restricted Ext Key Tel  
  
 PXR PBX Ext Line  
 PXV PBX Ext Line  
 PY4 PBX Add-On Pull Button  
 PY4KB PBX Add-On Illum Button  
 PY4XX PBX Add-On External Key  
  
 PYY PBX Restricted Ext Tel  
 PYYKX PBX Restricted Ext Key Tel  
 PZ8 PBX Controlled Ext Tel  
 PZ9 Switchboard 552D  
 RB9 900 Ring Back Ftr  
  
 RCJ Recorder Conn Jack  
 RCP Recorder Conn Temporary Equip  
 RCT Recorder Conn Equip  
 RCW Recorder Conn Equip Without Tone  
 RDJ Recorder Coupler  
  
 RLT Res Extra Listing  
 RX2K1 Centrex II Key Tel  
 RX2K2 Centrex II Key Tel  
 RX2K3 Centrex II Key Tel  
 RX2K4 Centrex I Key Tel  
  
 RX2K5 Centrex I Key Tel  
 RX2K6 Centrex I Key Tel  
 RX2K7 Centrex I Key Tel  
 RX2K8 Centrex I Key Tel  
 RX2K9 Centrex I Key Tel



## USOC WORD DESCRIPTION

RX2KA Centrex III Key Tel  
 RX2KB Centrex III Key Tel  
 RX2KC Centrex III Key Tel  
 RX2KD Centrex III Key Tel  
 RX2KE Centrex III Key Tel  
  
 RX2KF Centrex II Key Tel  
 RX2KH Centrex III Key Tel  
 RX2KQ Centrex II Key Tel  
 RX2L1 Centrex II Line  
 RX2L2 Centrex II Line  
  
 RX2L3 Centrex II Line  
 RX2L4 Centrex I Line  
 RX2L5 Centrex I Line  
 RX2L6 Centrex I Line  
 RX2L7 Centrex I Line  
  
 RX2L8 Centrex I Line  
 RX2L9 Centrex I Line  
 RX2LA Centrex III Line  
 RX2LB Centrex III Line  
 RX2LC Centrex III Line  
  
 RX2LD Centrex III Line  
 RX2LE Centrex III Line  
 RX2LF Centrex II Line  
 RX2LH Centrex III Line  
 RX2LQ Centrex II Line  
  
 RX2T1 Centrex II Tel  
 RX2T2 Centrex II Tel  
 RX2T3 Centrex II Tel  
 RX2T4 Centrex I Tel  
 RX2T5 Centrex I Tel  
  
 RX2T6 Centrex I Tel  
 RX2T7 Centrex I Tel  
 RX2T8 Centrex I Tel  
 RX2T9 Centrex I Tel  
 RX2TA Centrex III Tel  
  
 RX2TB Centrex III Tel  
 RX2TC Centrex III Tel  
 RX2TD Centrex III Tel  
 RX2TE Centrex III Tel  
 RX2TF Centrex II Tel  
  
 RX2TH Centrex III Tel  
 RX2TQ Centrex II Tel  
 RX3K7 Centrex II Key Tel  
 RX3K8 Centrex II Key Tel  
 RX3K9 Centrex II Key Tel

## USOC WORD DESCRIPTION

RX3L7 Centrex II Line  
 RX3L8 Centrex II Line  
 RX3L9 Centrex II Line  
 RX3T7 Centrex II Tel  
 RX3T8 Centrex II Tel  
 RX3T9 Centrex II Tel  
 RX4 Centrex I Restricted Tel  
 RX4KX Centrex I Restricted Key Tel  
 RX4LX Centrex I Restricted Line  
 RX5 Centrex I Restricted Tel  
  
 RX5KX Centrex I Restricted Key Tel  
 RX5LX Centrex I Restricted Ext Line  
 RX7 Centrex I Ext Tel  
 RX7KX Centrex I Ext Key Tel  
 RX7LX Centrex I Ext Line  
  
 RX9 Centrex I Restricted Ext Tel  
 RX9KX Centrex I Restricted Ext Key Tel  
 RX9LX Centrex I Restricted Ext Line  
 RXL Centrex III Ext Tel  
 RXLKX Centrex III Ext Key Tel  
  
 RXLLX Centrex III Ext Line  
 RXM Centrex III Integ Attd Console 1B  
 RXM2B Centrex III Integ Attd Console 2B  
 RXN Centrex III Restricted Tel  
 RXNKK Centrex III Restricted Key Tel  
  
 RXNLX Centrex III Restricted Line  
 RXO Centrex III Restricted Ext Tel  
 RXOKX Centrex III Restricted Ext Key Tel  
 RXOLX Centrex III Restricted Ext Line  
 RXP Centrex III Ext Tel  
  
 RXPKX Centrex III Ext Key Tel  
 RXPLX Centrex III Ext Line  
 RXQ Centrex III Restricted Tel  
 RXQKX Centrex III Restricted Key Tel  
 RXQLX Centrex III Restricted Line  
  
 RXR21 Centrex I Tel  
 RXR23 Centrex I Line  
 RXRKA Centrex III Key Tel  
 RXRKB Centrex III Key Tel  
 RXRKC Centrex III Key Tel  
  
 RXRKD Centrex III Key Tel  
 RXRKE Centrex III Key Tel  
 RXRKF Centrex I Key Tel  
 RXRKG Centrex I Key Tel  
 RXRKH Centrex III Key Tel

USOC WORD DESCRIPTION

RXRKO Centrex I Key Tel  
 RXXKQ Centrex I Key Tel  
 RXXK1 Centrex I Key Tel  
 RXXK2 Centrex I Key Tel  
 RXXK3 Centrex I Key Tel  
  
 RXXK4 Centrex II Key Tel  
 RXXK5 Centrex II Key Tel  
 RXXK6 Centrex II Key Tel  
 RXXK7 Centrex I Key Tel  
 RXRL1 Centrex 1 Line  
  
 RXRL2 Centrex 1 Line  
 RXRL3 Centrex 1 Line  
 RXRL4 Centrex II Line  
 RXRL5 Centrex II Line  
 RXRL6 Centrex II Line  
  
 RXRL7 Centrex II Line  
 RXRLA Centrex III Line  
 RXRLB Centrex III Line  
 RXRLC Centrex III Line  
 RXRLD Centrex III Line  
  
 RXRLE Centrex III Line  
 RXRLF Centrex I Line  
 RXRLG Centrex I Line  
 RXRLO Centrex I Line  
 RXRLQ Centrex I Line  
  
 RXRT1 Centrex I Tel  
 RXRT2 Centrex I Tel  
 RXRT3 Centrex I Tel  
 RXRT4 Centrex II Tel  
 RXRT5 Centrex II Tel  
  
 RXRT6 Centrex II Tel  
 RXRT7 Centrex II Tel  
 RXRTA Centrex III Tel  
 RXRTB Centrex III Tel  
 RXRTC Centrex III Tel  
  
 RXRTD Centrex III Tel  
 RXRTE Centrex III Tel  
 RXRTF Centrex I Tel  
 RXRTG Centrex I Line  
 RXRTH Centrex III Tel  
  
 RXRTO Centrex I Tel  
 RXRTQ Centrex Tel  
 RXS Centrex III Attendant Console 1B  
 RXS2B Centrex III Attendant Console 2B  
 RXT Attendant Transfer Feature

USOC WORD DESCRIPTION

RXU Centrex Ext Tel  
 RXUKX Centrex Ext Key Tel  
 RXULX Centrex Ext Line  
 RXV Centrex Restricted Ext Tel  
 RXVKX Centrex Restricted Ext Key Tel  
  
 RXVLX Centrex Restricted Ext Line  
 RXW Integrated Centrex Att'd Consul 1  
 RXW2A Integrated Centrex Att'd Consul 2  
 RXX Centrex Attendant Console 1  
 RXX2A Centrex Attendant Console 2  
  
 SN7 Hwy 1 Mile Sign  
 SPK Speakerphone Ftr 1A  
 SPKXX Speakerphone External 1A  
 ST2 Answer Serv Concentrator Connection  
 ST3 Concentrator Identifier  
  
 SUS Suspended Serv  
 T2S Touch-Tone Data Auxy Pad  
 T2SCX Touch-Tone Data Auxy Pad  
 T2SLX Touch-Tone Data Auxy Pad  
 TCH Noisy Location Trans Cut-Off Ftr  
  
 TCT Noisy Location Trans Ft Cut-Off Ftr  
 TDBCT TT B1 Console Ftr  
 TDBTT TT B1 Tel Ftr  
 TDJCC TT Public Tel Ftr  
 TDJCT TT CDR Ftr  
  
 TDJKT TT PB Tel Ftr  
 TDJNT TT Contempra Tel Ftr  
 TDJPT TT PRN Tel Ftr  
  
 TDJST TT Panel Single Slot Ftr  
 TDJTT TT Tel Ftr  
 TDNCF Touch-Tone on Centrex Line  
  
 TDNCP Touch-Tone on Centrex Line  
 TDP TT Dial Intercom Common Equip  
 TF3 Noisy Location Handset Ftr  
 TFK Trunk Line Combination  
 TFR Res Trunk Line  
  
 THB Trunk Line Message Rate  
 TLZ Coin Collector Intercom Tel  
 TM3 Trunk Line Message Rate Out  
 TTB Touch-Tone on Bus Line  
 TTN Touch-Tone on Centrex Pos

USOC WORD DESCRIPTION

TTR	Touch-Tone on Res Line
TTT	Hotel Toll Circuit
VLN	Impaired Hearing Handset Ftr
W13	Wats Tel
W13KX	Wats Key Tel

USOC WORD DESCRIPTION

W13LX	Wats Line
W13TX	Wats Trunk
XCA	Auto Exclusion Ftr
XCL	Exclusion Button
ZZZ	Special Assembly

PLANT SALES

**SERVICE CHARGES AND THEIR APPLICATION**

The term "Service Charge" (SC) designates charges for connection of service and/or telephones; installation of equipment other than telephones or lines; changes, moves or rearrangements of equipment and wiring; and temporary removal of equipment and wiring.

For residence service, one service charge covers all the installation work carried out on the same premises on one visit. For business service, separate service charges apply for each telephone installed, moved, changed or rearranged. In addition, a "colour charge" (CC) applies for each black telephone changed to a coloured telephone except where "Touch-Tone" service is provided also a "Princess Charge" (PC) for each Princess telephone installed.

Service charges will not apply for certain types of services, e.g.:

- Restoration of main service after Temporary Suspension of Service (SUS)
- Re-establishment of service at the same, or different premises after interruption caused by damage to the customer's premises beyond his control.
- Replacement of a residence telephone by any black or coloured telephone, the replacement of a Princess telephone or the installation of an extension, a bell chime, an extension bell or any other miscellaneous feature, if the main set is being replaced in a Company initiated telephone replacement program such as ANI conversions, transmission re-zoning, conversions from magneto to dial, etc.

- Changes of telephone sets for other Company reasons.
- Installation or change of location of any equipment on residence service if the work on other telephones or equipment for which a service charge applies.
- Change or rearrangement of drop wire, protector or connector block joining the outside and inside wiring.

*Note:* Any cases about which there is doubt as to the charges to be made or which are not described above shall be referred to the Business Office.

Telephones and miscellaneous equipment to be moved will be shown in the "RMKS" space of the service order by the Commercial Department. When a customer requests that equipment be moved and this is not specified on the order and is not required for Company reasons, the Installer shall notify the customer if a service charge applies. If the Installer is uncertain whether or not a service charge applies to the move, or if a service charge applies but the customer does not agree to pay, the case shall be referred to the Business Office for a ruling.

If the customer agrees to the move, the Installer shall notify the control centre clerk that a longhand correction is required on the order. The Installer and the control centre clerk shall correct their copies of the order by entering in the "RMKS" space the equipment moved, e.g. "MOVED SET", "MOVED 2 SETS" or "MOVED XB", together with the serial number of the longhand correction.

**Residence-Service Rates**

<b>Service</b>	<b>Monthly Rate</b>	<b>Service</b>	<b>Monthly Rate</b>
Individual Line		* Jack Weatherproof	.85
2 Party Line		* Vol. Cont. Revr. Ftr.	1.35
Multi Party		* Vol. Cont. Revr. Exten.	1.35
Extension	1.10-1.40	Vol. Cont. Hdst. Ftr.	1.35
Princess (per set)	.95	Impaired Hearing Hdst.	1.35
Contempra (per set)	1.95 + Reg. Tel. Rate	Touch Tone Res. Line (per line)	1.95
Bell Chime	.95	Cut-off	.35
Colour	**	Exclusion	.35
Regrades	*	13 ft. cord — 680 (Initial)	
Extra Listing	.35	13 ft. cord spring RCVR — 13.50 (Initial)	
Extension Bell	.50	* See rate group for locality	
Ext. Bell Loud	.75	** Colour Charge 9.55 (Initial)	
Jacks	.35	Princess Charge 6.40 (Initial)	

PIC CABLE COLOUR CODES

25 PAIR COLOUR CODE

PAIR NO.	TIP	RING
1	W	BL
2	W	O
3	W	G
4	W	BR
5	W	S
6	R	BL
7	R	O
8	R	G
9	R	BR
10	R	S
11	BK	BL
12	BK	O
13	BK	G
14	BK	BR
15	BK	S
16	Y	BL
17	Y	O
18	Y	G
19	Y	BR
20	Y	S
21	V	BL
22	V	O
23	V	G
24	V	BR
25	V	S

Even Count PIC Colour Code Chart

GR	COL	GR	COL	GR	COL	GR	COL
1	BL-W	25	BL-W-R	49	BL-W-BK	73	BL-W-Y
2	O-W	26	O-W-R	50	O-W-BK	74	O-W-Y
3	G-W	27	G-W-R	51	G-W-BK	75	G-W-Y
4	BR-W	28	BR-W-R	52	BR-W-BK	76	BR-W-Y
5	S-W	29	S-W-R	53	S-W-BK	77	S-W-Y
6	BL-R	30	BL-R-R	54	BL-R-BK	78	BL-R-Y
7	O-R	31	O-R-R	55	O-R-BK	79	O-R-Y
8	G-R	32	G-R-R	56	G-R-BK	80	G-R-Y
9	BR-R	33	BR-R-R	57	BR-R-BK	81	BR-R-Y
10	S-R	34	S-R-R	58	S-R-BK	82	S-R-Y
11	BL-BK	35	BL-BK-R	59	BL-BK-BK	83	BL-BK-Y
12	O-BK	36	O-BK-R	60	O-BK-BK	84	O-BK-Y
13	G-BK	37	G-BK-R	61	G-BK-BK	85	G-BK-Y
14	BR-BK	38	BR-BK-R	62	BR-BK-BK	86	BR-BK-Y
15	S-BK	39	S-BK-R	63	S-BK-BK	87	S-BK-Y
16	BL-Y	40	BL-Y-R	64	BL-Y-BK	88	BL-Y-Y
17	O-Y	41	O-Y-R	65	O-Y-BK	89	O-Y-Y
18	G-Y	42	G-Y-R	66	G-Y-BK	90	G-Y-Y
19	BR-Y	43	BR-Y-R	67	BR-Y-BK	91	BR-Y-Y
20	S-Y	44	S-Y-R	68	S-Y-BK	92	S-Y-Y
21	BL-V	45	BL-V-R	69	BL-V-BK	93	BL-V-Y
22	O-V	46	O-V-R	70	O-V-BK	94	O-V-Y
23	G-V	47	G-V-R	71	G-V-BK	95	G-V-Y
24	BR-V	48	BR-V-R	72	BR-V-BK	96	BR-V-Y

Odd Count PIC Colour Code Chart

PAIR NO. SEQUENCE	COLOR CODE TIP	COLOR CODE RING	PAIR NO. SEQUENCE	COLOR CODE TIP	COLOR CODE RING	PAIR NO. SEQUENCE	COLOR CODE TIP	COLOR CODE RING	PAIR NO. SEQUENCE	COLOR CODE TIP	COLOR CODE RING
1	R	BL	14	GO	S	27	P	S	40	BL	S
2	R	O	15	BK	BL	28	Y	S	41	R	W
3	R	G	16	W	S	29	BK	BR	42	R	Y
4	R	BR	17	BK	O	30	BK	S	43	R	BK
5	R	S	18	Y	BL	31	GO	P	44	R	GO
6	GO	BL	19	Y	O	32	BL	BR	45	R	P
7	GO	O	20	Y	G	33	BL	O	46	W	Y
8	GO	G	21	Y	BR	34	G	S	47	W	BK
9	W	BL	22	BK	G	35	O	BR	48	W	GO
10	W	O	23	P	BL	36	BL	G	49	W	P
11	W	G	24	P	O	37	O	G	50	Y	P
12	W	BR	25	P	G	38	G	BR	51	O	S
13	GO	BR	26	P	BR	39	BR	S			

UNITS



CABLE SIZE	UNIT SIZE	BINDER COLOUR CODE			
76	2 x 12 + 4 x 13	SEQUENCE	COLOUR	SEQUENCE	COLOUR
101	1 x 16 + 5 x 17	1	BL	6	BL - W
152	2 x 25 + 1 x 26 + 2 x 25 + 1 x 26	2	O	7	O - W
202	1 x 51 + 1 x 25 + 1 x 26 + 4 x 25	3	G	8	G - W
202 (19GA)	3 x 17 + 1 x 25 + 1 x 26 + 4 x 25	4	BR	9	BR - W
303	1 x 51 + 1 x 50 + 1 x 51 + 2 x 50 + 1 x 51	5	S		

## STATION ACCOUNTING

### Change of Location of Telephone Sets

28M — Moves of stations within a building from one location to another of the same customer are box marked (MOVE TEL) when:

- (a) the new location is already part of the customer's quarters or,
- (b) the old location is retained by the customer.

28C & 28X — Change of location of telephone sets from one address to another address or from one building to another building.

Codes 28C and 28X are charged and the associated station statistics are shown as inward or outward movement in the box spaces of the service order when the following circumstances apply:

- (a) change of location of telephones from one building to another for the same customer, even though both buildings are part of one establishment,

Note: Buildings which are built on the same continuous foundation and about one another but are conventionally distinguishable internally and externally as separate buildings, shall be considered as separate buildings.

- (b) change of location of telephones within a building from one address to another, for the same customer, where the customer both relinquishes the old address and acquires quarters at a new address.

Note: The customer is normally identified from the name appearing in the listing space of the service order.

It should be noted that changes of locations of telephone sets chargeable to 28C and 28X may be made on different types of service orders. When an "M" order is used, it is necessary to validate the inward and outward movement shown in the box spaces, by recording in the "FOR PLANT USE" space and reporting to the Control Centre the following information:

- (a) the old and new building designations or addresses,
- (b) the quantity of main sets involved, extension sets involved and PBX extensions involved, reported separately.

### Accounting Classification Sketches

#### Moves of Station Apparatus

C	B	A	A	F
Room 200	Room 202	Room 204	Room 206	Room 208
Room 201	Room 203	Room 205	Room 207	Room 209
C	D	D	E	E
	C			

#### Customer

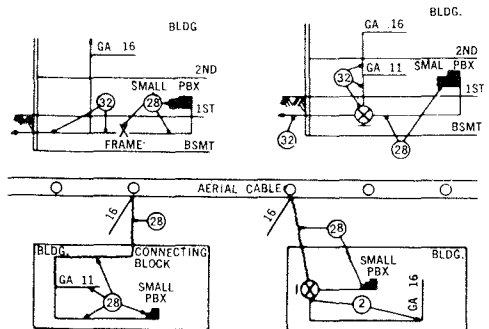
#### Acct. Codes

- A Moves stations between Rooms 204 and 206 . . . . . M
- A Adds stations to Room 204 . . . . . C
- B Moves stations to other floor but retains Room 202 . . . . . M
- B Removes stations from Room 202 . . . . . X
- C Relinquishes Room 203 and moves to Rooms 200 and 201 which were vacant . . . . . C & X

Note: This work may be done on more than one service order and over a period of time but is normally considered as one move only.

- D Moves stations to Room 203 but retains Room 205 . . . . . M
- E Relinquishes Room 208 and moves to Room 207 while retaining Room 209. Room 207 was previously vacant. . . . . C & X
- E Moves Stations to Room 207 from Room 209 co-incident with move from Room 208 . . . . . M
- F Moves from other building . . . . . C
- Removal in other building . . . . . X

#### Cable in Buildings to The Station Connection Code



**Method of Reporting  
New Drop and Block Wires  
Involving Multiple Drop Wire  
and Z Service Wire**

1. New drop and block wire built-one pair placed in use.



Multiple drop wire-report 3 new drop wires placed at time of installation regardless of number of pairs placed in service.

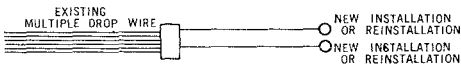
Z-service wire-report 1 new drop wire placed at time of installation regardless of number of pairs placed in service.

2. New installation of station using second pair of existing multiple. Drop wire-first pair in use.



Do not report any wires placed or reused.

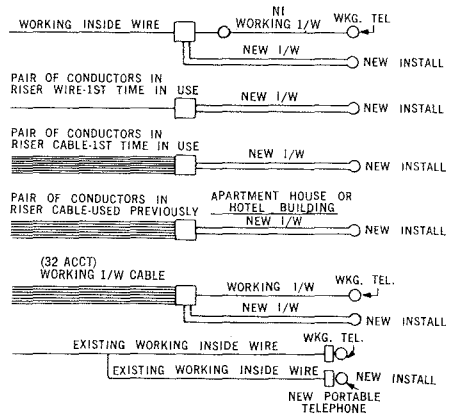
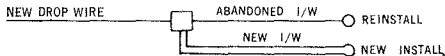
3. Installation of stations using pairs in existing multiple drop wire in which no pairs are in use.



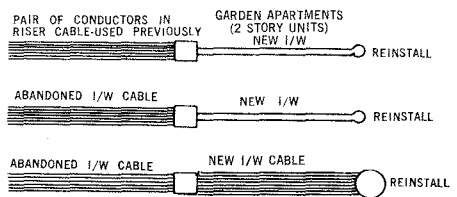
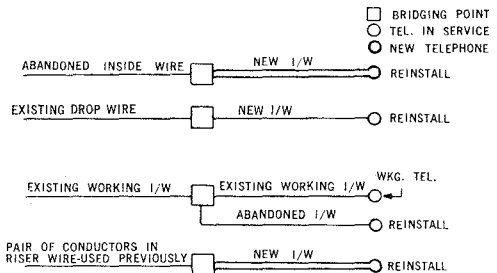
Report one drop wire reused for first pair placed in service.

**Examples of New Installs**

- BRIDGING POINT
- TEL. IN SERVICE
- NEW TELEPHONE
- JACK



**Examples of Reinstalls**



**OUTSIDE PLANT ACCOUNT CODES**

CLASS OF PLANT	RETIREMENT						MAINTENANCE (EXCEPT TEST DESK WORK)				
	CONSTRUCTION		PLANT RETIRED AND SALVAGE		COST OF REMOVAL		ORDINARY REPAIRS	REARRANGEMENTS AND CHANGES	TREE TRIMMING	SHOP REPAIRS	
	EX.	TOLL	EX.	TOLL	EX.	TOLL	EX. & TOLL	EX. & TOLL	EX. & TOLL	EX. & TOLL	
Pole Lines:											
Fully Owned	1C	1C	1X	1X	1X	1X	1R	1M			
Jointly Owned	31C	31C	31X	31X	31X	31X	1R	1M			
Foreign Owned	71C	71C	71X	71X	71C	71C	1R	1M			
Right of way	1C	41TC	—	—	—	—	1R				
Building Cable	32C	—	32X	—	32X	—	2R	2M			
Aerial Cable:											
Exchange	2C	—	2X	—	2X	—	2R	2M			
C.C.D. Systems	85C	—	82X	—	82X	—	22R	22M			
Toll	—	12TC	—	12TX	—	12TX	2R	2M			
U.G. Cable:											
Exchange	5C	—	5X	—	5X	—	5R	5M			
C.C.D. Systems	85C	—	85X	—	85X	—	25R	25M			
Toll	—	15TC	—	15TX	—	15TX	5R	5M			
Submarine Cable	55C	55C	55X	55X	55X	55X	55R	55M			
Buried Cable:											
Exchange	65C	—	65X	—	65X	—	65R	65M			
C.C.D. Systems	865C	—	865X	—	865X	—	265R	265M			
Toll	—	75TC	—	75TX	—	75TX	65R	65M			
Toll right of way	—	175TC	—	—	—	—	65R	—			
Buried Wire	95C	—	95X	—	95K	—	95R	95M			
Aerial Wire	3C	3TC	3X	3TX	3X	3TX	3R	3M			
U.G. Conduit	4C	4C	4X	4X	4X	4X	4R	4M			
All Above Classes of Plant	—	—	—	—	—	—	—	—	6R	6S	

**STATION ACCOUNT CODES**

CLASS OF PLANT	"C"		"X"		"R"	"M"	"S"
	MAT.	LAB.	MAT.	LAB.	M & L	M & L	M & L
		INCLUDE TEST WORK	RETURN AND SALVAGE	INCLUDE TEST WORK	ORDINARY REPAIR	RE-ARRANGE & CHANGE	SHOP REPAIR
Station Connections							
Teletypewriter	18C	18C	18X	18X	18R	18M	8S
Telephone and Miscellaneous	28C	28C	28X	28X	28R	28M	8S
Radio Telephone - Mobile Units & Other	38C	38C	38X	38X	38R	38M	38S
- Private Base Stations and Assoc. Antenna	98C	98C	98X	98X	98R	98M	38S
Coaxial Cable Distribution (C.C.D.)	48C	48C	48X	48X	48R	48M	8S
Service Entrances							
Large Private Branch Exchanges	58C	58C	58X	58X	58R	58M	8S
Special Station Equipment - Sage	258C	258C	258X	258X	258R	258M	258S
Data	68C	68C	68X	68X	68R	68M	8S
House Service - Public Telephones				328R			
Central Office Accounts							
Circuit - Exchange		257C		257X	17R	17M	
Radio Telephone - Toll		467C		467X	67R	67M	
- Exchange		567C		567X	67R	67M	



## STATION TESTS

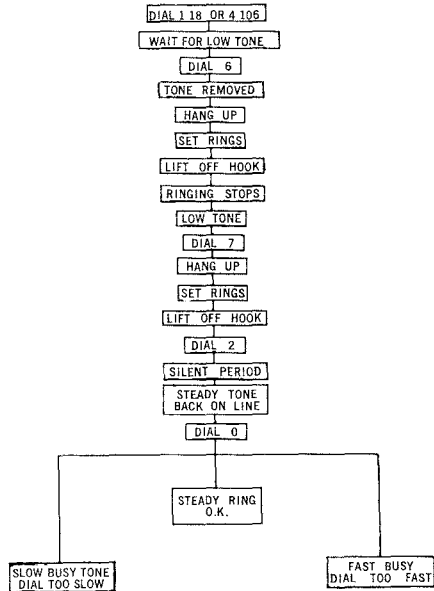
### Step by Step Offices Busy Back Tests (For Use at Terminals)

Always connect to a telephone wire or binding posts with test set in monitor position.

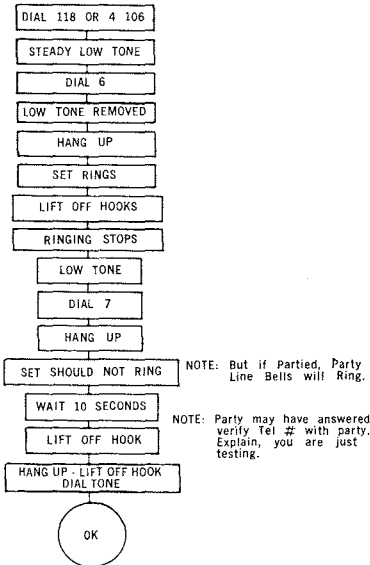
Dialing up a number from the pair that the number should be coming through on — and getting a “Busy Back” tells you *only* that someone — (probably you) — is causing the line to be “busy” after this test; the *positive* test is to dial your number from another pair — and “short” the pair the number should be on. If correct — your short will “trip” the ring, the same as if someone answered the line — if ring is not tripped request assistance from local test board.

When the service order indicates that a set is to be “re-connected — same spares” — the best busy back test is to have someone call you back — or call it yourself from another line.

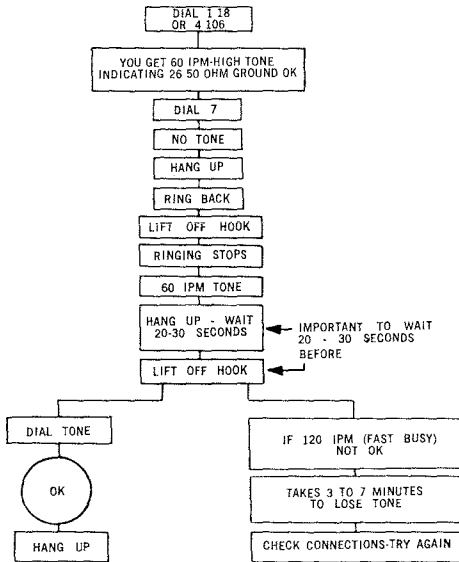
### Ring Back & Dial Speed Test Individual (Step By Step)



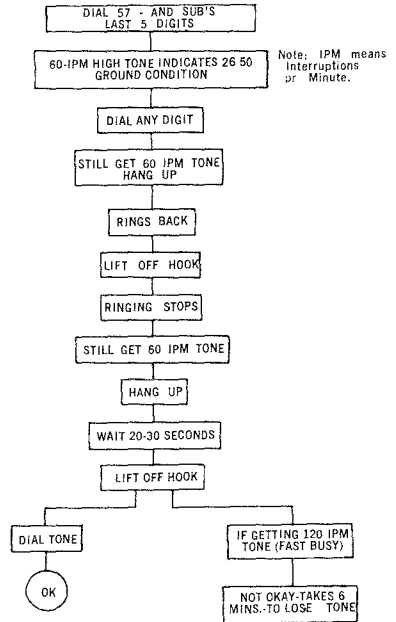
### Ring Back — Step by Step Type Offices Ring Party



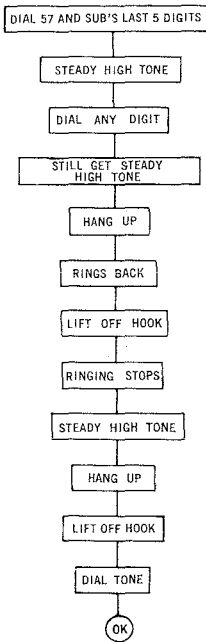
**Ring Back and ANI Check  
Step By Step Type Offices  
Tip Party ANI**



**Ring Back and A.N.I.  
Check Crossbar Type Offices  
Tip Party A.N.I.**



**Ring Back — Crossbar Type Office  
Ring Party or Individual**



**Crossbar Offices  
Busy Back Tests  
(For Use At Terminals)**

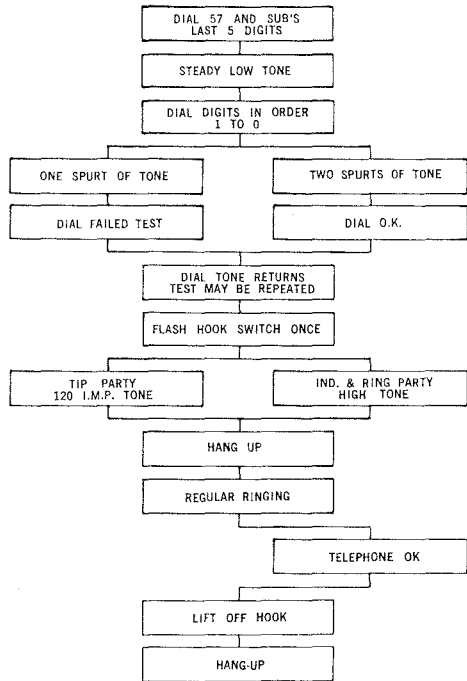
Always connect to a telephone wire or binding post with test set in monitor position. Connect test set to assigned pair, and, if you get dial tone dial 5-7 and last 5 digits in tel. number. If you get steady high tone-your number is coming through on this pair, hang up.

If you get busy tone — your number is not coming through on this pair — hang up.

Call central office to find out what number is on your pair.

If the service order indicates that a set is to be "reconnected—same spares" you may verify "busy back" and "ring back" from the set by testing.

**Touch Tone Dial, Station Ringer  
& ANI Test**



**NOTE: OTHER TONES OR RINGING SIGNALS INDICATE POSSIBLE TROUBLE CONDITION**

**ANI INSTRUCTIONS**

**Step 1** — MODIFY ALL TIP PARTY SETS ON ANY TYPE OF VISIT.

**Step 2** — DO ANI TEST

**Step 3** — REPORT ALL SET CONVERSIONS AND SUBSTITUTIONS TO YOUR DISPATCH DESK.

**Step 4** — ON CHANGES FROM TIP TO RING, REWIRE ALL SETS TO REMOVE IDFY GND.

No. 1 ESS And SP1 Instructions

No. 1 E.S.S. And SP1 Offices

BUSY BACK TESTS  
(For Use At Terminals)

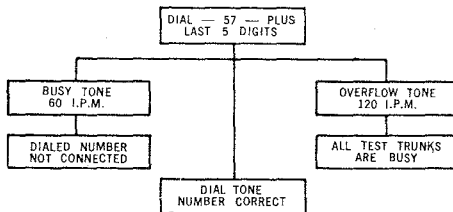
Always connect to a telephone wire with test set in monitor position. Connect test set to assigned pair, and, if you get dial tone, dial 57 and the last 5 digits in telephone number.

If you get dial tone, your number is coming through on this pair, hang up.

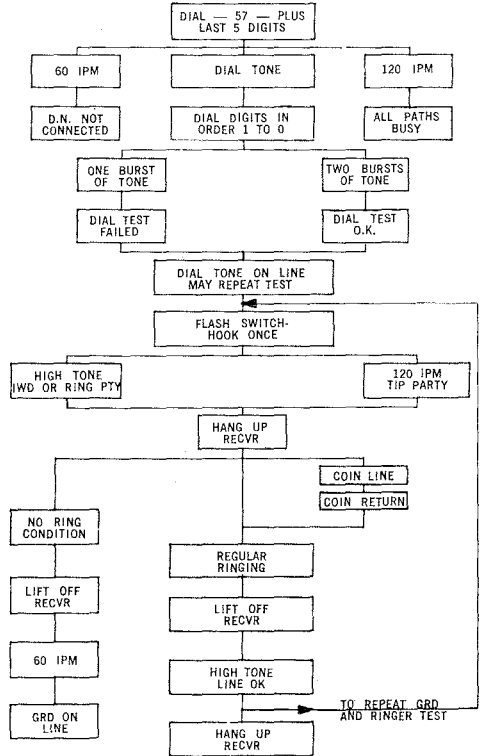
If you get busy tone (60 I.P.M.) — Your number is not coming through on this pair. Hang up. Call central office to verify your number is leaving frame.

If you get overflow tone (120 I.P.M.) — All paths are busy in central office. Hang up. Try again. If overflow tone continues call central office to verify circuit.

If the service order indicates that a set is to be "reconnected — same spares" you may verify "Busy Back" and "Ring Back" from the set.



No. 1. E.S.S. and SP1 Office Station Ringer and  
Touch-Tone Dial Test



## "Custom Calling Services"

### Operation

#### 1. "SPEED CALLING"

To make an abbreviated dialing call the subscriber:

- Goes off-hook and receives dial-tone.
- Dials "\*" or "11" plus 1 or 2 digits.
- Proceeds with the call in a normal manner.

#### 2. "CALL TRANSFER (Variable Transfer)"

The station having this service is referred to as the base station. The station to which calls are to be transferred (in the local calling area) is called the remote station.

To activate the service the base station subscriber:

- Goes off-hook and receives dial-tone
- Dials "\*" or "11" plus "91"
- Receives special dial-tone
- Dials remote station telephone number
- Verifies number when remote station answers
- Hangs up - service activated

If the remote station does not answer the service will not be activated. However, if the base station makes a second attempt to activate the same line within two minutes the service will be activated.

The following conditions indicate the disposition of an incoming call to the base station after transfer has been effected:

.. Both remote and base station idle

Only the remote station will be rung. The calling party hears audible ringing and will be connected to the remote station upon answer.

.. Base busy — remote idle

Same as above — remote station will ring.

.. Both remote and base busy

Calling party will receive busy tone.

.. Base idle — remote busy

Calling party will receive busy tone.

Thus, once a transfer has been established only the remote station can receive calls made to the base station. The base station may be used to make outgoing calls while in transfer condition.

To deactivate the service the base station subscriber:

- Goes off-hook and receives dial-tone
- Dials "\*" or "11" plus "93"
- Receives confirmation tone
- Hangs up - service deactivated

The service is normally deactivated from the base station. However, if circumstances warrant it, the service can be deactivated from the central office.

#### 3. "THREE-WAY CALLING"

To add a third party to an established connection the subscriber proceeds as follows: -

- Flashes switchhook and gets special dial-tone
- Dials the directory number (7 digits) of the third party, conference is now established with the added party only.
- Flashes switchhook again to add the first party called.
- Flashes switchhook to exclude the added party.

NOTE: Flashes should be between .5 and 1.5 seconds.

This process restores the original connection and a new party can be added.

As previously noted, only one of the three conferees may be located outside the local calling area. (This restriction is automatically administered by the ESS machine.)

## SERVICE ORDERS

### Installation Service — Missed Appointments

An appointment date and time entered on the due date space of a service order is the *Company's* commitment to fulfill the customers request for service.

If the commitment is missed a code which indicates the reason for the failure is entered on the service order. In selecting the missed appointment code the general rule that shall be followed is:- any appointment date that is missed in any situation over which the customer does not have control must be coded "not met for Company reasons."

#### Missed Appointment Codes

##### Company Reasons

PL — Plant work load conditions

- Manpower shortage
- No access after 5:00 pm or other specified time on the order

PF — Lack of facilities

- Outside plant
- Central office

PO — All other company reasons

- Shortage of equip
- Picket lines prevent access to customers premises or company's facilities
- Delay in order issuance or equipment left-off order in error

##### Customer Reasons

SA — No access

- 8:00 am to 5:00 pm or other access time specified on the order

SR — Customer not ready

- Plant employee notified at time of field visit
- Facilities customer to furnish not installed such as conduit outlets etc.

SL — Customer requests later date through marketing or business office before work is started

SO — All other customer reasons including

- Customer requests order due later be completed first which results in a missed due date
- Order changes due to plant sale activity or customer requests that involve additional work and original due date cannot be met

### Left-in Telephone and Removal Information

#### REMOVALS

- Make removal visits the same day as orders are dispatched.
- When sets are removed, report completion to the I.C.C. and record number of sets, date removed and name on "IW" copy.
- When access cannot be gained:  
Contact building owner, superintendent or real estate agent, if known.  
Ask nearest neighbours for information.  
Note the results of these efforts, the date and name on the "IW" copy.  
Do not enter occupied premises to remove equipment unless the present occupier or his representative is present.
- Return all "IW" copies, completed or not, to the foreman at the end of the day.

#### RECONNECTS

- *I.I.P. Information on Service Order:* Report as reconnects if the left-in telephones are physically reconnected or if new sets are used to replace the left-in telephones due to condition, change of colour, etc.
- *No I.I.P. Information on Service Order — Sets Found on Premises:* Report same as if I.I.P. information was on service order, enter I.I.P. information on "IW" copy. Report found sets to the left-in telephone clerk.

LOSSES — REMOVAL AND RECONNECT VISITS

Reporting Service Order Completions

— **Sets Missing:** Check with customer (tenant, landlord, janitor) to ensure that sets have not been inadvertently stored out of sight, i.e. closet, basement.

Note results, date and name on the "IW" copy.

— **Sets Working:** Enter "found working" and the working telephone number on the "IW" copy of order. Score out the I.I.P. information if a reconnect order.

— **Unrecoverable:** Set removals where access cannot be gained.

— **Casualty:** Enter details on the "IW" copy of order.

— **All Losses:** Report loss condition to the I.C.C. Return the "IW" copy to the foreman at the end of the day.

1. Give Name
2. Service Order Number
3. Corrections — Plant Sales — Foreman's Code
4. Box Marking
5. Time to Account Codes
6. Completion Time — Clock Hours  
e.g. 1½ Hrs. 8:00 - 9:30

FOUND SETS

— Report all found telephones to the left-in telephone clerk.

7. Service Order Number — Next Job

FAILURE TO COMPLY WITH THESE REPORTING PROCEDURES RESULTS IN:

- Incorrect left-in telephone records.
- Incorrect field stocks inventories.
- Incorrect application of work credits.
- Incorrect "audit trail" records.
- Costly "write-off" procedures.

## Guide For Service Order Box Space Entries

FLD VST	INWARD - C INST REINST REC	OUTWARD-X REMOVED LI	DROPS NEW REUSED	MOVE TEL	SUBST	REG/ REASOC	CD/HS CHN	STN JK PLCD	CARD CHN	JK/KY/EXTB MVD/SUBST	EXT BELL PLACED	SUS/ RES
------------	-------------------------------	-------------------------	---------------------	-------------	-------	----------------	--------------	----------------	-------------	-------------------------	--------------------	-------------

- FLD VST. — "O" — No field visit.  
— "1" — Field visit (regardless of the number of locations visited).
- INWARD C  
INST., REINST., REC. — Enter the number of telephones installed, reinstalled and reconnected. Show reinstall for each station on SUS that is connected to another customer. The "O" or "F" order that terminates this service or the line on SUS must show a removal — (For definitions of Install, Reinstall and Reconnect, refer to V26.003 Station Accounting Guide for Station Equipment and Station Connections, Part 5.)
- OUTWARD X  
REMOVED LI — Enter the number of telephones removed or left-in. On a reconnect order where the entry in the "NO OF TELS IP" space exceeds the number of telephones reconnected enter the number of telephones removed. The number reconnected plus the number removed must equal the number shown in the "NO OF TELS IP" space.
- DROPS  
NEW REUSED — Enter the number of drops installed or reused. Enter 3 when multiple drop wire is placed regardless of the number connected. **DO NOT** enter new drop wires placed in connection with regrades or changes work.
- MOVE TEL — Enter the number of working telephones moved. An order which involves an inside move of any station as well as regrading of service is counted as an inside move. **DO NOT** count inside moves on telephones which are reconnected, moves for maintenance reasons or wiring moves.
- SUBST — Enter the number of working telephones substituted. **DO NOT** count substitutions on stations which are reconnected, moved involved in conversions (dial ANI, etc.) or substitutions for maintenance reasons.
- REG/REASOC — Enter the number of regrades or reassociations.  
Regrade orders are scored per main station and cover the following changes in service:  
(a) Two-Party to One-Party, etc., and vice versa.  
(b) Message Rate to Flat Rate, etc., and vice versa.  
(c) Residence to Business, etc., and vice versa.  
(d) Non-Coin to Coin and vice versa.  
Reassociation orders are scored per main station or per station as follows:  
(a) Transfer of party-line main stations from one party line to another.  
(b) Transfer of bridged PBX or Centrex stations from one extension station to another.  
(c) Transfer (reassociation) of extension stations to main stations.  
(d) Transfer (reassociation) of a station from PBX to Centrex (C.O.)  
Note: **DO NOT** count stations involved in inside moves or any items for which a field visit was not made.
- CD/HS CHN — Enter the number of cord or handset changes where no other work was done at the same station or on the same or related service order.
- STN JK PLCD — Enter the number of station jacks connected for service. Exclude station jacks that were in place and reconnected. Also exclude items for which a field visit was not required.
- CARD CHN — Enter one per telephone worked when the number card, instruction card, Touch-Tone faceplate or Touch-Tone mat is changed on a field visit specifically requested on a Plant Work Order, service order or list. **Do not** tally when done in connection with other installation work. Also enter one for each station "Number Card Change" made when changing PBX stations to Centrex (C.U.), when field work is authorized by a plant work order list.
- JK/KY/EXTB  
MVD/SUBST — Enter the number of station jacks, extension bells, gongs, horns and chimes and voice couplers moved or substituted and for which a non-recurring charge applies. Do not count external keys.
- EXT BELL  
PLACED — Enter the number of extension bells, chimes, gongs, horns, relay controls or voice couplers placed. Do not count items that were in place. Do not count signal buzzers, whether internal or external to the telephone set or external signals on keys.
- SUS/RES — Enter the number of **main** stations temporarily suspended or restored to service.



# TELEPHONE NUMBERS

## INSTALLATION CONTROL CENTRE

---

---

---

---

---

## ASSIGNORS REGULAR

---

---

---

---

---

## ASSIGNORS 1A KEY & PBX

---

---

---

---

---

## ASSIGNORS LEFT IN

---

---

---

---

---

## FACILITIES DESK

---

---

---

---

---

## TEST BOARD

---

---

---

---

---

## REPAIR CONTROL DESK

---

---

---

---

---

## CABLE TESTING

---

---

---

---

---

## PLANT SALES

---

---

---

---

---

## SUPPLIES

---

---

---

---

---

## C.O. FRAMES

---

---

---

---

---

## VEHICLES

---

---

---

---

---



## UNIVERSAL SERVICE ORDER (USO)

THE FOLLOWING PAGES HAVE BEEN INSERTED  
IN THIS MANUAL TO PROVIDE ADDITIONAL  
REFERENCE MATERIAL FOR THOSE CENTRES  
USING UNIVERSAL SERVICE ORDER (USO).

### PLANT SALES — /PS

A Plant Sale (PS) is entered in the S & E section of the USO on the same line as the telephone set USOC associated with the item sold. The mnemonic code "PS", together with certain suffixes, provide identification of the individual Plant group responsible for the sale(s).

Suffix entries to the mnemonic code "PS" are meaningful segments of data and are as follows:

- (1) Alpha-numeric designation for the Plant district organization to be credited with the sale(s).

To assist in identifying Plant sales, foreman's codes are used; (e.g., 53-43) the first two digits "53" identifies the district, the third digit "4" identifies the unit and the fourth digit "3" identifies the foreman.

- (2) Alpha designation to identify Plant work group to be credited with the sale(s).
  - (a) I — Installation
  - (b) R — Repair (Maintenance)
  - (c) O — Other
- (3) Numeric designation to identify a portion of the USOC entry to be credited to the Plant force.
  - (a) The digit "1" (one) indicates that the first part of the USOC was sold by Plant.
  - (b) The digit "2" (two) indicates the suffix part of the USOC was sold by Plant.
  - (c) The digit "3" (three) indicates a regrade was sold by Plant.
  - (d) No third entry indicates the entire USOC item was sold by Plant.

## GUIDE FOR SERVICE ORDER STATISTICAL ENTRIES

<b>CC</b>		
L T D	T N REC. DATE	
NO. OF TELS IP	LIT FILE CODE 46	LIT FILE NO. 47-48
-----STAT		
/FV _____	/NI _____	
/RI _____	/RE _____	
/DPN _____	/TSR _____	
/LI _____		
/OCB _____		
ERM _____	TRM _____	
VER _____	TT _____	

- /FV — “O” — No field visit.  
— “1” — Field visit.
- /NI — Stations installed. Enter the number of stations installed.
- /RI — Stations reinstalled. Enter the number of stations reinstalled. Show re-install for each telephone on TSS that is connected for another customer. The D or F order that terminates this service or the line on TSS must show a removal.
- /RE — Stations reconnected. Enter the number of stations reconnected.
- /DPN — Drop wire new. Enter only the number of new drop or block wires placed in connection with a new install of a station or line. The drop must be new in its entirety and cannot reuse any previously placed wire for any portion of the drop.  
  
— Do not tally new drops placed in connection with reinstalls, regrades or other work changes.
- /TSR — Total stations removed. Enter the total number of stations removed. On a reconnect order where the entry in the “No. of Tels IP” space exceeds the number of telephones reconnected, enter the number of telephones removed. The number reconnected plus the number removed must equal the number shown in the “No. of Tels IP” space.
- /LI — Left-in telephones. Enter the number of telephones left-in.
- /OCB — Order completed by. Enter your initials.
- ERM — Exception report made.
- TRM — Transmission requirements met.
- VER — Verification of equipment. (Initials of completion clerk).
- TT — Time and date transmitted on completion network.

### ORDER CLASSIFICATION

T or ET	To new address
F or EF	From old address
N	New connect
D	Disconnect (complete disconnect)
C	Change
R	Record
SS	Suspend Service
RS	Restore Service

### ACTION CODES

Each item of equipment is entered on an order preceded by an action code. The following action codes are used in the S & E:

<u>Action Code</u>	<u>Description</u>
I	In
O	Out
C	Change <i>from</i> and
T	<i>to</i>
C	Change <i>from</i> and
X	<i>to</i> and <i>move</i>
M	Move same premises
R	Recap
D	Delete
E	Enter

The action code is entered in the first typing position in the Code column of the order, e.g.,

9 10	I	1FREC
---------	---	-------

# USOC

## FIRST SUFFIX — COLOUR

(Alphabetical by Colour)

The first suffix character is used to indicate the colour of the instrument or item of equipment as follows:

<u>Colour</u>	<u>1st Suffix</u>
Beige	E
Black	B
Blue	L
Chrome	H
Custom (Special Assembly)	C
Gold	A
Grey	D
Green	G
Ivory	V
Mauve	M
Pink	P
Red	R
Transparent	N
Turquoise	T
White	W
Yellow	Y
Other:	
<i>Colour does apply</i> and specific colour is unknown.	X
<i>Colour does apply</i> specific colour shown with another USOC code for special instrument.	S
Colour does <i>not</i> apply (also used with code 1 to indicate line only.)	O

**TELEPHONES AND SUPPLEMENTAL EQUIPMENT  
SECOND SUFFIX (TYPE OF TELEPHONE STATION EQUIPMENT)**

	Permanent			Portable		
	Rotary	Touch-Tone	Non-Dial	Rotary	Touch-Tone	Non-Dial
Desk Style — Hand Combined, Princess, Contempra.	C	T	N	P	5	U
<b>Pushbutton Instruments</b>						
—1-Button (including Slide-Switch Princess)	G	8	H	Q	7	—
—1-Button Combined Wall	M	3	L	—	—	—
—Multi-Button	K	6	A	—	—	—
—Multi-Button Combined Wall	B	4	Z	—	—	—
Wall Combined, Contempra	W	2	S	—	—	—
<b>Call Directors &amp; Business Interphone Instruments</b>						
Second Suffix (Operation) C — Rotary or not applicable T — Touch-Tone						
Not available indicated by (—)						

*Note:* If second suffix is not required on items which must carry colour, an "X" filler code will be used as the fifth character: Example: Beige Speakerphone 3A External shown as (SP4EX)

**ALPHABETIC LIST OF MNEMONIC CODES  
(ASSIGNING & LOADING)**

Abbrev.	Description	Order Section & Entry			
		Code Column	Floated	Code Column or Floated	Box on Fielded Lines
ABC	Answerback Code		S & E	LSTG	
ACR	Auxiliary Line Cutoff Relay		ASGM		
ADD	Address		ASGM		
ALM	PBX Alarm Cct		ASGM		
AMP 238A	Amplifier 238A		ASGM		
APP	Application Date				IDENT
AR	Advance Relay		ASGM		
ARI	Account Responsibility Indicator	IDENT			
BB	Bunching Block		ASGM		
BL	Bridge Lifter		ASGM		
BMF	Bridge Main Frame		ASGM		
BRG	Bridge Party(s) Telephone Number		ASGM		
BS	Battery Supply		ASGM		
BTA	Basic Termination Agreement		S & E		
BUB	Bunching Block		ASGM		
BXT	Bridged at X'Conn Term		ASGM		
CBE	Common Battery Equipment		ASGM		
CD	Completion Date				IDENT
CKT	Circuit	IDENT			
CLN	Coin Lock Number		ASGM STAT		
CON	Concentrator Identifier		ASGM		
CRO	Complete With Related Order			IDENT	
CS	Class of Service		ASGM		IDENT
CSCC	Centralized Service Control Centre		ASGM		
CT	Connect Through		ASGM		
DD	Due Date				IDENT
DES	Description		S & E		
DGN	Designation		LSTG		



**ALPHABETIC LIST OF MNEMONIC CODES  
(ASSIGNING & LOADING) — Cont'd**

Abbrev.	Description	Order Section & Entry			
		Code Column	Floated	Code Column or Floated	Box on Fielded Lines
DMG	Departmental Mileage Grouping		S & E		
DN	Departmental Number	IDENT			
DNT	Do Not Transfer		ASGM		
DOP	Dedicated Outside Plant		ASGM		
DPA	Different Premises Address		S & E		
DPN	Drop Wire — New		STAT		
DPO	Directory Post Office	DIR			
DXJ	Do Not Remove Cross Connect Jumper		ASGM		
EBD	Effective Billing Date		IDENT S & E		
ESL	Essential Service Line		S & E	IDENT	
EXCH	Exchange				IDENT
F1 } F2 } F3 }	Facility Number		ASGM		
FR	From		S & E		
FV	Field Visit	STAT			
GEN	Generator Supply		ASGM		
GFT	Gift Service	IDENT			
GRM	Ground Resistance Measurement		ASGM STAT		
GS	Gift Service	LSTG	S & E		
HTG	Hunting (Work Equiv.)			S & E	
HV	High Voltage		ASGM		
ID	Issue Date		IDENT		
IŞA	Initial Service Agreement		LSTG S & E		
JK	Jack		ASGM		
KS	Key System		IDENT S & E		
L	Language Code				IDENT

**ALPHABETIC LIST OF MNEMONIC CODES  
(ASSIGNING & LOADING) — Cont'd**

Abbrev.	Description	Order Section & Entry			
		Code Column	Floated	Code Column or Floated	Box on Fielded Lines
LA	Listed Address			LSTG	
LC	Line Concentrator— Concentrator Identification		ASGM		
LDC	Load Coil		ASGM		
LG	Language	IDENT			
LI	Left-In Telephones		STAT		
LID	Left-In Telephone Data		ASGM		
LLE	Long Line Equipment		ASGM		
LN	Listed Name	LSTG			
LOC	Location	LSTG	S & E		
LRM	Loop Resistance Measurement		ASGM STAT		
LSA	Service System Business Subscriber Listing	LSTG			
LSB	Service System Residence Subscriber Listing	LSTG			
LSR	Service System Line		S & E		
LST	Line or Station Transfer		ASGM		
LT	Line Terminal		ASGM		
LTD	Letter Designation		S & E		
MC	Mail Copy	IDENT			
MFV	Main Frame Vertical		ASGM		
ML	Multiline Wire Lead		ASGM		
MNN	Misc Number Network (ANI, ONI)		ASGM		
NHT	Non Hunting	S & E			
NI	Station Installed		STAT		
NNC	Number Network Cable (ANI)		ASGM		
NPU	Non-Published Listing	LSTG			
NT	No Telephone Number		S & E		

**ALPHABETIC LIST OF MNEMONIC CODES**  
**(ASSIGNING & LOADING) — Cont'd**

Abbrev.	Description	Order Section & Entry			
		Code Column	Floated	Code Column or Floated	Box on Fielded Lines
OAB	Order Assigned By		ASGM		
OCB	Order Completed By		STAT		
OCS	Old Class of Service				IDENT
OE	Originating Equipment			ASGM	
OKS	OK Service		ASGM		
OKWC	OK Wire Chief		ASGM		
ORD	Order Classification and Number				IDENT
PD	Previously Dedicated		ASGM		
PIT	Public Indoor Telephone		S & E		
POS	Position		ASGM		
POT	Public Outdoor Telephone		S & E		
PR	Protection Required		ASGM		
PS	Plant Sale	LSTG	S & E		
PTY	Parity Designation		ASGM		
PU	Pick Up		S & E		
PV	Province Code	IDENT			
PXJ	Place Cross-Connect Jumper		ASGM		
RBI	Retainable Billing Information	BILL	S & E		
RE	Stations Reconnected		STAT		
REF	Reference		S & E		
REQ	Requisition Number		ASGM		
RES	Restore Service	IDENT S & E			
RGN	Register Number		S & E		
RGR	Register Reading		S & E		
RI	Stations Re-Installed		STAT		
R ISOL	Ringer Isolator		ASGM		
RMK	Remarks — Temporary	RMKS	S & E		
RMKR	Remarks — Permanent	RMKS			
RNG	Ringng Combination		ASGM		

**ALPHABETIC LIST OF MNEMONIC CODES**  
(ASSIGNING & LOADING) — Cont'd

Abbrev.	Description	Order Section & Entry			
		Code Column	Floated	Code Column or Floated	Box on Fielded Lines
RO	Related Order			IDENT	
ROL	Ring On Line		S & E		
RPR	Rural Party Route		ASGM		
RT	Route or Block		ASGM		
RTE	Rate	LSTG	S & E		
RXJ	Remove Cross-Connect Jumper		ASGM		
RZ	Resistance Zone		ASGM		
SA	Service Address	LSTG			
SBC	Special Billing Codes		S & E		
SC	Sleeve Connection Relay		ASGM		
SCN	Serial Check Number		ASGM STAT		
SCO	Special Central Office Equipment		ASGM		
SD	Subsequent Due Date		IDENT		
SIG	Signal		S & E		
SLS	Sales Code				IDENT
SN	Special Number		S & E		
SSCN	Special Service Circuit Number		S & E		
SSM	Special Safeguarding Measures		ASGM		
SSP	Special Service Protection		ASGM		
STA	Station Number		S & E		
SUB	Sub Board	IDENT			
SUS	Suspend Service or On Suspension	IDENT S & E			
TBA	Tens Block Relay		ASGM		
TBS	Tens Block Screening		ASGM		
TC	Establish, Change or Discontinue Normal Transfer of Calls	TFC			
TCP	Transfer of Calls Through Date Specified	TFC			

**ALPHABETIC LIST OF MNEMONIC CODES  
(ASSIGNING & LOADING) — Cont'd**

Abbrev.	Description	Order Section & Entry			
		Code Column	Floated	Code Column or Floated	Box on Fielded Lines
TCS	Establish, Change or Discontinue Transfer of Calls with Screening for More Than One Called Party	TFC			
TCT	Establish, Change or Discontinue Temporary Transfer of Calls	TFC			
TIE	Tie Cable		ASGM		
TKB	Trunk Billing		S & E		
TN	Telephone Number	ASGM	IDENT S & E	LSTG	IDENT
TRK	Trunk Cable		ASGM		
TSR	Total Stations Removed		STAT		
TYA	Type of Account	IDENT			
TZ	Transmission Zone		ASGM		
UR	Urban Route		ASGM		
VR	Voice Repeater		ASGM		
WOL	Wire Out of Limits		ASGM		



**ISSUED BY**  
**H.Q. PLANT — ADMINISTRATIVE SERVICES E.R.**